

Proceedings e report

110

International Workshop on Finite Elements for Microwave Engineering

From 1992 to Present & Proceedings of the
13th Workshop

edited by

Roberto D. Graglia, Giuseppe Pelosi,
Stefano Selleri

Firenze University Press
2016

International Workshop on Finite Elements for Microwave Engineering : from 1992 to Present & Proceedings of the 13th Workshop / edited by Roberto D. Graglia, Giuseppe Pelosi, Stefano Selleri. – Firenze : Firenze University Press, 2016.

(Proceedings e report ; 110)

<http://digital.casalini.it/9788866559689>

ISBN 978-88-6655-967-2 (print)

ISBN 978-88-6655-968-9 (online)

Peer Review Process

All publications are submitted to an external refereeing process under the responsibility of the FUP Editorial Board and the Scientific Committees of the individual series. The works published in the FUP catalogue are evaluated and approved by the Editorial Board of the publishing house. For a more detailed description of the refereeing process we refer to the official documents published on the website and in the online catalogue of the FUP (www.fupress.com).

Firenze University Press Editorial Board

G. Nigro (Co-ordinator), M.T. Bartoli, M. Boddi, R. Casalbuoni, C. Ciappei, R. Del Punta, A. Dolfi, V. Fargion, S. Ferrone, M. Garzaniti, P. Guarnieri, A. Mariani, M. Marini, A. Novelli, M.C. Torricelli, M. Verga, A. Zorzi.

This work is licensed under a Creative Commons Attribution 4.0 International License (CC BY 4.0): <http://creativecommons.org/licenses/by/4.0/legalcode>

© 2016 Firenze University Press
Università degli Studi di Firenze
Firenze University Press
via Cittadella, 7, 50144 Firenze, Italy
www.fupress.com
Printed in Italy



CONTENTS

Foreword	IX
<i>Roberto D. Graglia, Giuseppe Pelosi, Stefano Selleri</i>	
Welcome Message from the IEEE Antennas and Propagation Society and Announcement of the next FEM2018 Edition	XI
<i>Roberto D. Graglia</i>	
See you in Cartagena: ICEAA-IEEE APWC & FEM 2018!	XIII
ICEAA Some History and a Welcome Message to the 2018 International Workshop on Finite Elements for Microwave Engineering	XVII
<i>Roberto D. Graglia, Piergiorgio L.E. Uslenghi</i>	
Why are there Penguins on this Book Cover?	XXIII
<i>Giuseppe Pelosi</i>	
Part I	
From 1992 to Present	1
«Memorabilia»	3
Numerical Treatment of the Plane Torsion Problem for Multiply Connected Domains	9
<i>Richard L. Courant</i>	
Finite-Element Solution of Homogeneous Waveguide Problems	13
<i>Peter P. Silvester</i>	
Finite Elements in Electrical Engineering: The First 50 Years	19
<i>Peter P. Silvester</i>	
Workshop Posters and Call for Papers, from 1992 to Present	45
Reports of Past Editions, from the Pages of the <i>IEEE Antennas and Propagation Magazine</i>	59

Part II	
Proceedings of the 13th Workshop	87
Welcome to FEM 2016	89
Plenary Session	93
Technical Sessions	99
Author's Index	179
Acknowledgments	183

FOREWORD

This book does not only contain the Proceedings of the 13th International Workshop on Finite Elements for Microwave Engineering but, since the Workshop is “back home” to Tuscany and Florence, where it started in 1992, a part dedicated to the history of the Workshop is also present.

This Workshop originated from a collaboration between the University of Florence (Italy) and McGill University of Montreal (Quebec, Canada). The first edition, May 26-27, 1992, was indeed a National Workshop, organized by the University of Florence, in San Miniato, where the most preeminent invited speaker was Peter P. Silvester from McGill University.

P.P. Silvester does not need to be presented to the Finite Elements community. He brought Finite Elements in electrical engineering in 1968 and published the very first work on Finite Elements applied to electromagnetism in 1969, after the seminal paper of Richard L. Courant (1943). The manuscript P.P. Silvester presented at FEM 1992 Workshop is here reproduced in full, it is a very enjoyable history of Finite Elements up to 1992 and an ideal starting point for our new history, which cover 24 years and 13 Workshop editions.

Second edition, in 1994, was the first truly international one, jointly organized by the University of Florence (Italy) and the McGill University of Montreal (Quebec, Canada). Conference was still in Italy, and in Tuscany, this time in Siena, and was a great success. The third edition ought to be in Halifax (Nova Scotia, Canada), but P.P. Silvester’s health problems, which eventually lead to his premature passing that same year, prevented the Workshop to take place. Notwithstanding this, the fourth Workshop took place in Poitiers, France, in 1998 and, since then, it remained an international biannual event, and took its current name.

This celebrating book is organized as follows. Part I presents, besides the numerical appendix to the seminal paper by Courant, Silvester’s first FEM paper as applied to electromagnetic wave problems (1969) and his aforementioned 1992 manuscript, some «memorabilia» from previous Workshop editions, from call for papers to posters and reprints of the reports published on the *IEEE Antennas and Propagation Magazine* covering some of the previous editions of the Workshop.

Part II contains the papers, seventy, presented at the 2016 Workshop, divided into twelve technical sessions which fixes the state of the art, worldwide, of the Finite Element methods as applied to microwave engineering, as well as partially broadening the scope of the conference shedding some light also on applications of Finite Elements to other research fields.

We are of course in debt with many people for this successful Workshop, first of all the Scientific Committee, then to session organizers, session chairs and sponsors, as well as all contributing researchers, speakers and audience. A special thank is then due to the local organizers, and in particular to Stefano Maddio (University of Florence, Italy), who handled the edition of the proceedings and Elson Agastra (Polytechnic University of Tirana, Albania) for his helpful support.

A special thank is also due to current and past Editor-in-Chief of *IEEE Antennas and Propagation Magazine*, Mahta Moghaddam and W. Ross Stone, respectively, who in these years contributed to the success of the Workshop promoting it on the pages of the Magazine both by publishing calls for papers and reports of the Workshops. A special thank is also due to Mary E. Brennan (IEEE Central Offices), for her kind help in obtaining reprint permission for *IEEE Antennas and Propagation Magazine* reports; and to David B. Davidson (Stellenbosch University, South Africa) who produced from his archives part of the material here reproduced.

*Roberto D. Graglia, Politecnico di Torino, General Co-Chair
Giuseppe Pelosi, University of Florence, General Co-Chair
Stefano Selleri, University of Florence, Scientific Secretary*

Florence and Turin, May 2016.

WELCOME MESSAGE FROM THE IEEE ANTENNAS AND PROPAGATION SOCIETY AND ANNOUNCEMENT OF THE NEXT FEM2018 EDITION

Dear Colleagues and Friends:

As the Immediate Past President of the IEEE Antennas and Propagation Society, I am glad to welcome all participants to the thirteenth International Workshop on Finite Elements for Microwave Engineering. This well established international workshop is sponsored by the IEEE Antennas and Propagation Society, whose field of interest encompasses: antennas, including analysis, design, development, measurement, and testing; radiation, propagation, and the interaction of electromagnetic waves with discrete and continuous media; and applications and systems pertinent to antennas, propagation, and sensing, such as applied optics, millimeter- and sub-millimeter-wave techniques, antenna signal processing and control, radio astronomy, and propagation and radiation aspects of terrestrial and space-based communications, including wireless, mobile, satellite, and telecommunications.

In the past, I have often discussed the future of this workshop with Giuseppe Pelosi and the entire organizing committee of the present edition. While it is true that a very focused event on Finite Elements in Microwave Engineering is of great importance to our community, since it allows for a fruitful exchange of knowledge that cannot be attained in any larger, more dispersive conference, it is also true that a large number of competing conferences scattered all around the world and through the year makes it difficult for the interested and active researchers to take part in all the scientific events they wish to attend.

Hence, we concurred on the fact that, while the Finite Element Workshop needs to maintain its distinguishing focused topics and audience, it might also profit from being organized in the same location, and at the same time of another broader conference dealing with similar matters. Of course, among the possible conferences, one organized by the IEEE Antennas and Propagation Society would be a premium choice.

The International Conference on Electromagnetics in Advanced Applications (ICEAA), which is held together with the IEEE-APS Topical Conference on Antennas and Propagation in Wireless Communications (IEEE-APWC) satisfies this requirement, since it deals with advanced electromagnetics with a particular attention to numerical methods. Therefore, we decided that the next fourteenth edition of the International Workshop on Finite Elements for Microwave Engineering will be jointly held with the twentieth edition of ICEAA and the eight edition of IEEE-APWC. It is now too early to fix the exact dates for the next Workshop, but the location will most probably

be Cartagena, Colombia, in South America.

I invite all of you to attend and contribute to the FEM 2018 Workshop in Cartagena, to be held in conjunction with the 2018 ICEAA-IEEE APWC conferences. We are confident that you will love the venue!

*Roberto D. Graglia,
2015 IEEE APS President 
Chairman of ICEAA - IEEE APWC Organizing Committee*

Turin, May 2016.

SEE YOU IN CARTAGENA: ICEAA-IEEE APWC & FEM 2018!

Cartagena de Indias is a city on the northern coast of Colombia in the Caribbean Coast Region and capital of the Bolívar Department (Fig. 1).

The city was founded on June 1, 1533, by Spanish commander Pedro de Heredia (Madrid circa 1505 - Zahara de los Atunes, Cádiz, Spain, January 27, 1554), in the former location of the indigenous Caribbean Calamarí village and named after Cartagena, Spain, where most of Heredia's sailors had resided (Fig. 2). However, settlement in this region around Cartagena Bay by various indigenous people dates back to 4000 BC. During the colonial period Cartagena served a key role in administration and expansion of the Spanish empire. It was a center of political and economic activity due to the presence of royalty and wealthy viceroys. In 1984 Cartagena's colonial walled city and fortress were designated a UNESCO World Heritage Site.



Fig. 1: Colombia, and Cartagena.

For more than 275 years, Cartagena was under Spanish rule. On November 11, 1811, Cartagena declared its independence, but by mid-1815 a large Spanish expeditionary fleet besieged Cartagena and after a five-month siege the fortified city fell on December 1815 and returned under Spanish



Fig. 2: Map of Cartagena - Hand-colored engraving, by Baptista Boazio, 1589 (Library Of Congress - Jay I. Kislak Collection, in public domain).



Fig. 3: Sunset over Cartagena Harbor as seen from La Popa (Norma Gómez, Flickr, CC).

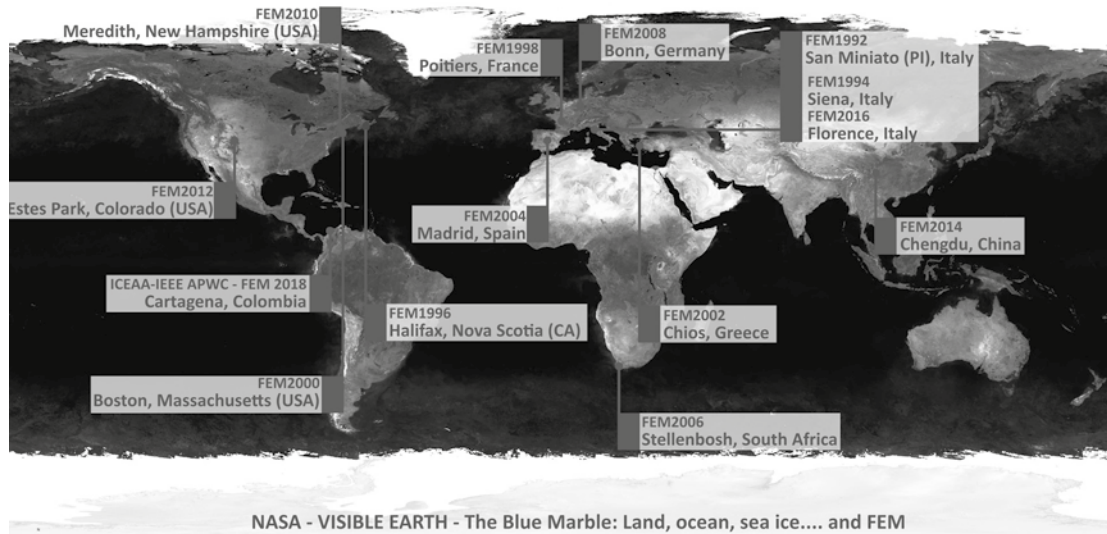

Fig. 4: Locations of the Finite Element Workshop all over the world, from 1992 to Florence 2016, and to next one in Cartagena 2018.

domination. In 1821 Simón Bolívar led a new revolt which eventually brought to the end of the Viceroyalty of New Granada and the birth of the Republic of Colombia, organized as a union of the current territories of Colombia, Panama, Ecuador, Venezuela, parts of Guyana and Brazil and north of Marañón River. Simón Bolívar became the first President of Colombia, and Francisco de Paula Santander was made Vice President. However, the new republic was unstable and ended with the rupture of Venezuela and Ecuador in 1830.

Colombia was the first constitutional government in South America, and the Liberal and Conservative parties, founded in 1848 and 1849 respectively, are two of the oldest surviving political parties in the Americas.

Cartagena has now a rising commercial vocation, to be a city of more than 900,000 people and become tourist destination, the city offers a wide range of shops where they are recognized chain stores, department stores, international franchise and specialized areas trade (Fig. 2). We hence wish to see the all of you in Cartagena (Colombia) for ICEAA-IEEE APWC & FEM 2018 (Fig. 4).

ICEAA SOME HISTORY AND A WELCOME MESSAGE TO THE 2018 INTERNATIONAL WORKSHOP ON FINITE ELEMENTS FOR MICROWAVE ENGINEERING

The International Conference on Electromagnetics in Advanced Applications (ICEAA) has always been organized by the Politecnico di Torino, that is one of the two major technical Universities in Italy (the other major Italian technical University is the Politecnico di Milano.) Torino was the first capital of unified Italy (1861–1864), and the University of Torino (founded in 1424) and the Politecnico di Torino (founded in 1859) have a very long tradition in science. Many prominent scholars studied or taught at the Politecnico di Torino, for example, to name a few, Ascanio Sobrero (1812–1888), the first to synthesize nitroglycerin and sobrerol, Galileo Ferraris (1847–1897) who invented the induction motor, Vilfredo Pareto (1848–1923) who developed the concept of Pareto efficiency and the field of microeconomics, Alessandro Artom (1867–1927) who invented the radiogoniometer, and the mathematician and engineer Gustavo Colonnetti (1886–1968) who was a Rector of the Politecnico di Torino, President of the Italian National Research Council and founder of the Institute of Metrology named after him.

Many other scientists should also be recognized for their very strong relationships with the Politecnico di Torino and, among those, we like to mention a few who were honored by the Laurea Honoris Causa from the Politecnico di Torino: Enrico Mattei (in Mining Engineering, 1953), Battista Pininfarina (in Architecture, 1963), Francesco G. Tricomi (in Aeronautics, 1967), Nuccio Bertone (in Architecture, 1993), Nathan Marcovitz (in Electronic Engineering, 1993), Benoit B. Mandelbrot (in Civil Engineering, 2005), Rita Levi Montalcini (in Bioengineering, 2006), Sergio Marchionne (in Business Engineering, 2008), Giorgetto Giugiaro (in Architecture, 2010), Leon Ong Chua (in Electronic Engineering, 2015).

Also, many prominent scientists were active in Torino, for example the great mathematician Giuseppe Luigi Lagrange (1736–1813) who founded the Academy of Sciences of Torino, the chemist Amedeo Avogadro (1776–1856), the archeologist Bernardino Drovetti (1776–1852) who founded the Torino Egyptian Museum (the second in the world after the one in Cairo), the astronomers Giovanni Antonio Amedeo Plana (1781–1864) and Giovanni Schiaparelli (1835–1910), and the anthropologist Cesare Lombroso (1835–1909).

The International Conference on Electromagnetics in Advanced Applications (ICEAA) has been held every other year in Torino since its first edition of 1989. In 1989, the name of the Conference was International Conference on Electromagnetics in Aerospace Applications, which was changed in 1991 to the new name, with no modification of the Conference acronym. Starting with its twelfth edition of 2010 held in Sydney, Australia, the conference became an annual event held in

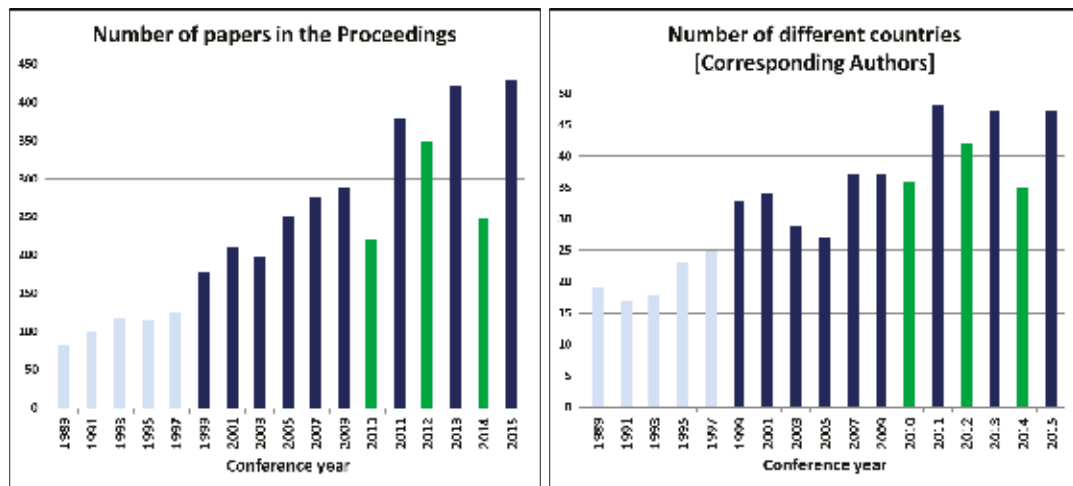

Fig. 1: Left: Number of papers per year at the ICEAA; right: Number of countries from which corresponding authors submitted papers to ICEAA by year.

Italy on odd years and outside Italy on even years. The others out-of-Italy editions of ICEAA are the 2012 fourteenth edition held in Cape Town, South Africa, the 2014 sixteenth edition held in Palm Beach, Aruba, and the next eighteenth edition to be held in Cairns, Australia, from 19 to 23 September, 2016. ICEAA obtained the continuing technical co-sponsorship of the IEEE Antennas and Propagation Society in 2003, which permits ICEAA to submit its Conference Proceedings to the IEEE Xplore Digital Library.

All the ICEAA editions, starting from the seventh one (2001) onward, were supported by the ISMB (Istituto Superiore Mario Boella) and by the Torino Wireless Foundation. For this support, the ICEAA Organizing Committee is very grateful to the Founder and President of those institutions, Prof. Rodolfo Zich, who actually started the ICEAA Conference series in 1989. Prof. Zich was also a the Rector of the Politecnico di Torino for 14 years (1987–2001) and the Chair of the Electromagnetics research group of the Politecnico until 2011.

Starting with its sixth edition in 1999, the ICEAA Scientific Committee has been chaired by Prof. Piergiorgio Uslenghi of the University of Illinois at Chicago (a graduate in Electrotechnical Engineering of the Politecnico di Torino), while the ICEAA Organizing Committee has been chaired by Prof. Roberto Graglia of the Politecnico di Torino.

Information on the number of papers published in the Conference Proceedings and on the nationality of the corresponding authors are summarized in Fig. 1. From these graphs, it is clear that ICEAA became a well established international conference from its sixth edition of 1999 onward, and that it is also highly reputed for its editions held outside Italy. More than half of the scientific sessions of ICEAA are organized by prominent scientists, while the conference maintains a highly selective acceptance rate for the regular contributed papers due to the fact that the Organizing Committee has decided not to have more than five parallel sessions. Among the past Special Session organizers we like to remember here the few well respected scientists who unfortunately passed away: Prof. Leopold B. Felsen, Prof. Roberto Tiberio, Dr. Carl E. Baum, and Prof. Karl J. Langenberg.

ICEAA covers all the industrial and social areas where advanced applications of Electromagnetics are of importance. Since 2011, ICEAA has been coupled to the IEEE Topical Conference on Antennas and Propagation in Wireless Communications (IEEE APWC), that is an annual conference started in 2011 and fully financially sponsored by the IEEE Antennas and Propagation Society. IEEE APWC is focused on the ICT area (wireless communications and technology).

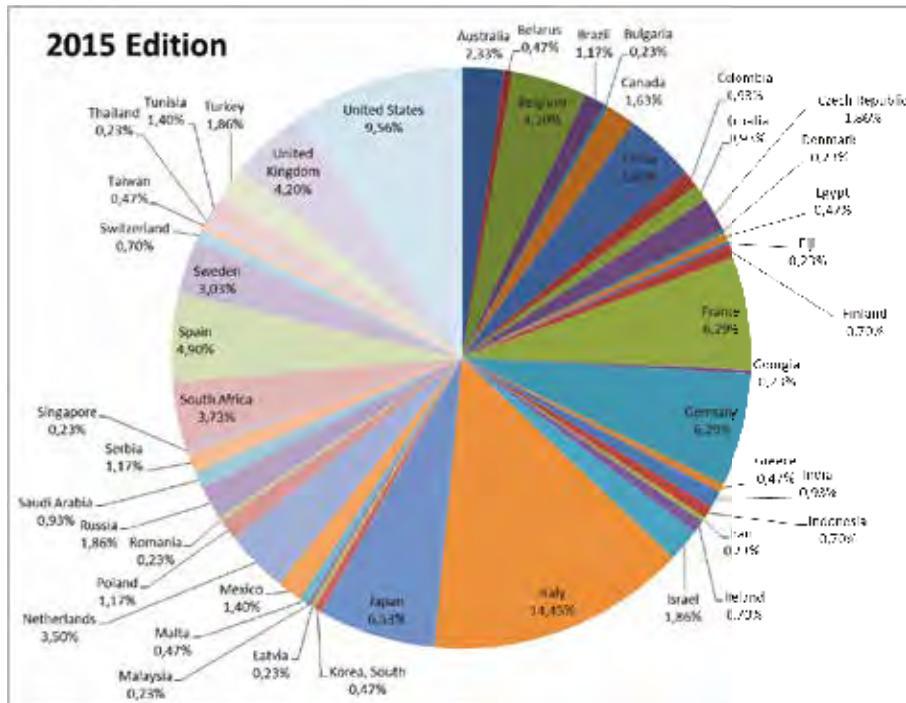

Fig. 2: ICEAA-IEEE APWC 2015 breakdown.

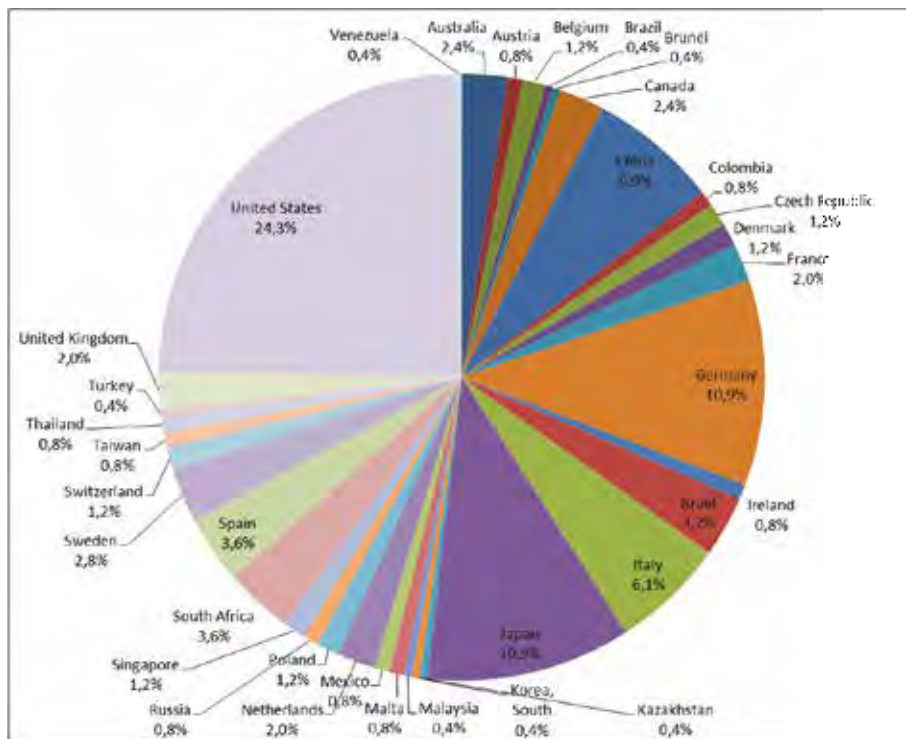

Fig. 3: ICEAA-IEEE APWC 2014 breakdown.



CALL FOR PAPERS

INTERNATIONAL CONFERENCE ON ELECTROMAGNETICS
IN ADVANCED APPLICATIONS (ICEAA 2016)

IEEE-APS TOPICAL CONFERENCE ON ANTENNAS AND PROPAGATION
IN WIRELESS COMMUNICATIONS (IEEE APWC 2016)

September 19-23, 2016

Cairns, Australia

www.iceaa-offshore.org

Information for Authors

Authors must submit a full-page abstract electronically by February 26, 2016. Authors of accepted contributions must submit the full paper, executed copyright form and registration electronically by June 3, 2016. Instructions are found on the website. Each registered author may present no more than two papers. All papers must be presented by one of the authors. Please refer to the website for details.

Deadlines:

Submission of abstract
Notification of acceptance
Final manuscript and presenter registration

February 26, 2016
April 8, 2016
June 3, 2016



The eighteenth edition of the International Conference on Electromagnetics in Advanced Applications (ICEAA 2016) is supported by the Politecnico di Torino, by Macquarie University, and by the Istituto Superiore Mario Boella, with the principal technical cosponsorship of the IEEE Antennas and Propagation Society and the technical cosponsorship of the International Union of Radio Science (URSI). It is coupled to the sixth edition of the IEEE-APS Topical Conference on Antennas and Propagation in Wireless Communications (IEEE-APWC 2016). The two conferences consist of invited and contributed papers, and share a common organization, registration fee, submission site, workshops and short courses, banquet, and social events. The proceedings of the conferences will be submitted to the IEEE Xplore Digital Library.



All inquiries should be directed to:

Prof. Roberto D. Graglia
Chair of ICEAA – IEEE APWC Organizing Committee
Dipartimento di Elettronica e Telecomunicazioni
Politecnico di Torino
Corso Duca degli Abruzzi, 24
10129 Torino, ITALY
roberto.graglia@polito.it

Prof. Piergiorgio L. E. Uslenghi
Chair of ICEAA – IEEE APWC Scientific Committee
Department of ECE (MC 154)
University of Illinois at Chicago
851 South Morgan Street
Chicago, IL 60607-7053, USA
uslenghi@uic.edu

Prof. Paul D. Smith
Chair of ICEAA - IEEE APWC 2016 Local Organizing Committee
Department of Mathematics
Macquarie University
Sydney, NSW 2109, Australia
paul.smith@mq.edu.au

ICEAA Topics

1. Adaptive antennas
2. Complex media
3. Electromagnetic applications to biomedicine
4. Electromagnetic applications to nanotechnology
5. Electromagnetic education
6. Electromagnetic measurements
7. Electromagnetic modeling of devices and circuits
8. Electromagnetic packaging
9. Electromagnetic properties of materials
10. Electromagnetic theory
11. EMC/EMI/EMP
12. Finite methods
13. Frequency selective surfaces
14. Integral equation and hybrid methods
15. Intentional EMI
16. Inverse scattering and remote sensing
17. Metamaterials
18. Optoelectronics and photonics
19. Phased and adaptive arrays
20. Plasma and plasma-wave interactions
21. Printed and conformal antennas
22. Radar cross section and asymptotic techniques
23. Radar imaging
24. Radio astronomy (including SKA)
25. Random and nonlinear electromagnetics
26. Reflector antennas
27. Technologies for mm and sub-mm waves

APWC Topics

1. Active antennas
2. Antennas and arrays for security systems
3. Channel modeling
4. Channel sounding techniques for MIMO systems
5. Cognitive radio
6. Communication satellite antennas
7. DOA estimation
8. EMC in communication systems
9. Emergency communication technologies
10. Indoor and urban propagation
11. Low-profile wideband antennas
12. MIMO systems
13. Mobile networks
14. Multi-band and UWB antennas
15. OFDM and multi-carrier systems
16. Propagation through forested areas
17. Radio astronomy (including SKA)
18. RFID technologies
19. Signal processing antennas and arrays
20. Small mobile device antennas
21. Smart antennas and arrays
22. Space-time coding
23. Vehicular antennas
24. Wireless mesh networks
25. Wireless security
26. Wireless sensor networks

Fig. 4: ICEAA-IEEE APWC 2016 poster.

Both conferences consist of invited and contributed papers, and share a common organization, registration fee, submission site, workshops and short courses, banquet, and social events.

The pie diagram of Fig. 2 shows that the highest number of papers published in the 2015 Proceedings came from Italy, second is the USA, then Japan, France and Germany, UK and Ireland. The pie diagram of Fig. 3 is relative to the 2014 out-of-Italy edition and shows that the highest number of papers published in the 2014 Proceedings came from the USA, second were Japan and Germany, then China.

We are happy that the 2018 edition of the International Workshop on Finite Elements for Microwave Engineering will be jointly held with the 2018 ICEAA-IEEE APWC conferences. We welcome all participants to this Workshop, and we encourage them to contribute to the success of this international event in 2018.

Very cordially,

Roberto D. Graglia, Chairman of ICEAA - IEEE APWC Organizing Committee
Piergiorgio L.E. Uslenghi, Chairman of ICEAA - IEEE APWC Organizing Committee

Turin, May 2016.

WHY ARE THERE PENGUINS ON THIS BOOK COVER?

As it has been written earlier on this book, the idea of this Workshop derives from a technical and scientific collaboration between the McGill University of Montreal (Quebec, Canada) and the University of Florence (Italy). In particular between Peter P. Silvester and myself.

Peter had, like me, penguins among his most favorite animals. Hence in my visits to Montreal in the years from 1991 to 1996, a visit to the Biodome and its marvelous penguins was mandatory. From this the idea of using penguins on this book cover.



Fig. 1: Left: Peter P. Silvester (January 25, 1935 - October 11, 1996); right: the emblem of McGill University, where P.P. Silvester taught from 1964 to 1996.

I met Peter for the first time in July, 1991, in Montreal, and since then an intense scientific collaboration and deep friendship started. To Peter's teachings and expertise is due a great portion of the growth of the scientific activity in the field of numerical analysis at the University of Florence in those years.

Peter Silvester was born on January 25, 1935, in Tallin, Estonia, and graduated from the Carnegie Institute of Technology (now Carnegie-Mellon University) in 1956. After a period of industrial practice, he continued his studies at the University of Toronto, obtaining the MSc in 1958, and then at McGill University, Montreal (Quebec, Canada), where he was awarded the PhD in Electrical Engineering, in 1964. He initially joined the Department of Electrical Engineering at McGill as Lecturer, then as Assistant Professor, Associate Professor, and Full Professor. In 1996, he was honored with the titles of Emeritus Professor at McGill University, and Honorary Professor at the University of British Columbia.



Fig. 2: Montreal Biodome and its penguins.

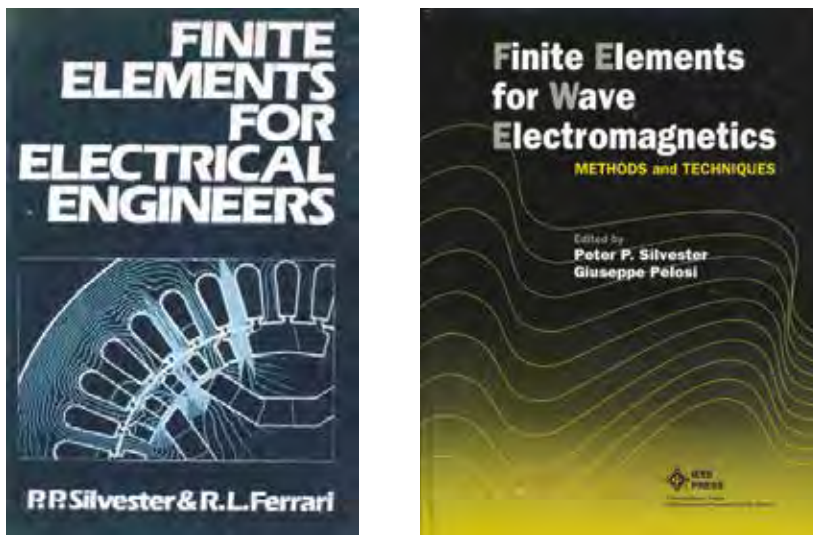

Fig. 3: Left: P.P. Silvester and R.L. Ferrari book on Finite Elements for Electrical Engineering which was the first of its kind (1983); Right: A later book, by P.P. Silvester and G. Pelosi, collecting key papers on Finite Elements and edited by IEEE Press (1994).

Peter devoted a large part of his career to the numerical analysis of electromagnetic fields, with applications to magnetics, microwaves, geomagnetics, antennas, and bioelectricity. His main research focused on the FEM, as applied to electromagnetics, where he has been a pioneer. His paper, “Finite-Element Solution of Homogeneous-Waveguide Problems,” presented at the 1968 URSI Symposium on Electromagnetic Waves, and later on, published in the Italian technical journal, *Alta Frequenza*, was definitely the first FEM application to electronic engineering.

In this field, his contributions have been extremely valuable, both from the theoretical and the applications side. He studied topics which ranged from potential and scalar-wave problems, in the first years, to applications to microwave devices, antennas, electric machines, as well as new kinds of elements and formulations, open-boundary problems, and parallel computing. His book, *Finite Elements for Electrical Engineering*, written with Ron Ferrari, has been the only textbook on this specific topic for many years, and it has been translated into many languages, among which are Russian, Chinese, Japanese, and Spanish.

He founded the Computational Analysis and Design Laboratory (CAD-Lab) at the Electrical Engineering Department of McGill University, in 1978, which has now become probably the largest research organization of its kind in Canada, and one of the largest in the world. Peter Silvester also

was a founder of Infolytica Co. (Montreal), a consulting and software manufacturing company.

Peter Silvester maintained strong research ties with colleagues of several other institutions, notably the University of Cambridge and the University of Florence, creatively sharing his knowledge. He also acted as a consultant to a number of major corporations and government agencies. He was a member of major professional organizations in his field, a member of steering committees and boards of various scientific and professional conferences, and was elected a Fellow of the IEEE for "...contributions to the art of finite-element analysis." He was also a Fellow of the IEE, and of the Royal Society of Canada.

Peter P. Silvester left us on October 11, 1996 in Victoria, (British Columbia, Canada), after a short illness. His ashes were dispersed in Victoria, in the Anderson Hill park, facing the Pacific Ocean. I also wish to point you to the paper by Ron Ferrari, "The Finite-Element Method, Part 2: P.P. Silvester, an Innovator in Electromagnetic Numerical Modeling," (*IEEE Antennas and Propagation Magazine*, vol. 49, no. 3, 2007, pp. 216-234) and dedicated to the scientific activity of Peter P. Silvester.

*Giuseppe Pelosi,
Department of Information Engineering, University of Florence*

Florence, May 2016.

Part I
From 1992 to Present

This part retraces the history of the International Workshop on Finite Elements for Microwave Engineering through some key points and «memorabilia». It is worth to remember that the first, national edition of the Workshop held in S. Miniato, Italy, 1992, not only focused on technical and scientific contents, but also celebrated 50 years since Richard L. Courant paper “Variational Methods for the Solution of Problems of Equilibrium and Vibration,” (*Bulletin of the American Mathematical Society*, vol. 49, 1943, pp. 1-23). Such a paper also contains the appendix “Numerical Treatment of the Plane Torsion Problem for Multiply Connected Domains”. This appendix was the first official appearance of the Finite Element technique.

Indeed, the Finite Element Method, in its presently accepted forms, can be credited to no lesser a person than R.L. Courant. When he prepared the published version of his 1942 address to the American Mathematical Society, he added a two-page appendix to show, by example, how the variational methods first described by Lord Rayleigh could be put to wider use in potential theory. Using piecewise-linear approximations on a set of triangles, which he called “elements,” he dashed off a few two-dimensional examples – and the Finite Element Method was born. It remained dormant for half a generation, probably waiting for computer to be widely spread (G. Pelosi, “The finite-element method, Part I: R. L. Courant,” *IEEE Antennas and Propagation Magazine*, vol. 49, no. 2, 2007, pp. 180-182).



Fig. 1: Left: Richard L. Courant (January 8, 1888 – January 27, 1972); right: QR codes pointing to Courant documentary movie on YouTube.



Fig. 2: FEM1992 Workshop, San Miniato, Italy, Book of Proceedings.

In the first Chapter of this part both Courant's original 1942 appendix and P.P. Silvester's 1969 paper on *Alta Frequenza* are reproduced. Furthermore, P.P. Silvester produced a manuscript, on the basis of his lecture in S. Minaito, which was included in FEM 1992 proceedings (Fig. 1) and re-printed here for the first time.

In San Miniato stemmed the idea of an International Workshop, and indeed second edition, in 1994, was the first truly international one, jointly organized by the University of Florence, Italy, and the McGill University, Montreal, Canada.

Conference was still in Italy: 2nd International Workshop on Finite Elements in Electromagnetic Wave Problems, Siena, Italy, May 24-26, 1994. The third Workshop was scheduled to take place in Halifax (Nova Scotia, Canada) on July 9-11, 1996, but was cancelled at the last minute, due to the deteriorating health of Peter P. Silvester. The 4th was the one in which the name was definitely settled to "International Workshop on Finite Elements for Microwave", with subtitle "From Electromagnetics to Microwave Electronics Software" Poitiers, France, July 10-11, 1998. The complete list is:

- *Giornata di studio su: Il metodo degli elementi finiti nelle applicazioni dell'elettromagnetismo [National Workshop on Finite Elements as Applied to Electromagnetics]*
San Miniato (Pisa), May 26-27, 1992.
Special issue: M. Calamia, G. Pelosi, [Eds.], "Il metodo degli elementi finiti nell'elettromagnetismo [The finite element method in electromagnetics]," *Alta Frequenza-Rivista di Elettronica*, vol. IV, no. 5, September-October 1992.
- *2nd International Workshop on Finite Elements in Electromagnetic Wave Problems*
Siena, Italy, May 24-26, 1994.
Special issue: M. Calamia, G. Pelosi, P.P. Silvester, [Eds.], "Finite Element Methods in Electromagnetic Wave Problems," *COMPEL*, vol. 13, Supplement A, May 1994. pp. v+211-405
A report of this conference, appeared on *IEEE Antennas and Propagation Magazine*, vol. 36, no. 4, 1994, pp. 60-61, is reproduced in the following.
- *3rd International Workshop on Finite Elements in Electromagnetic Wave Problems*
Halifax, Nova Scotia, Canada, July 9-11, 1996.
(not held)



Fig. 3: FEM1994 Workshop, Siena, Italy, Group Photo.

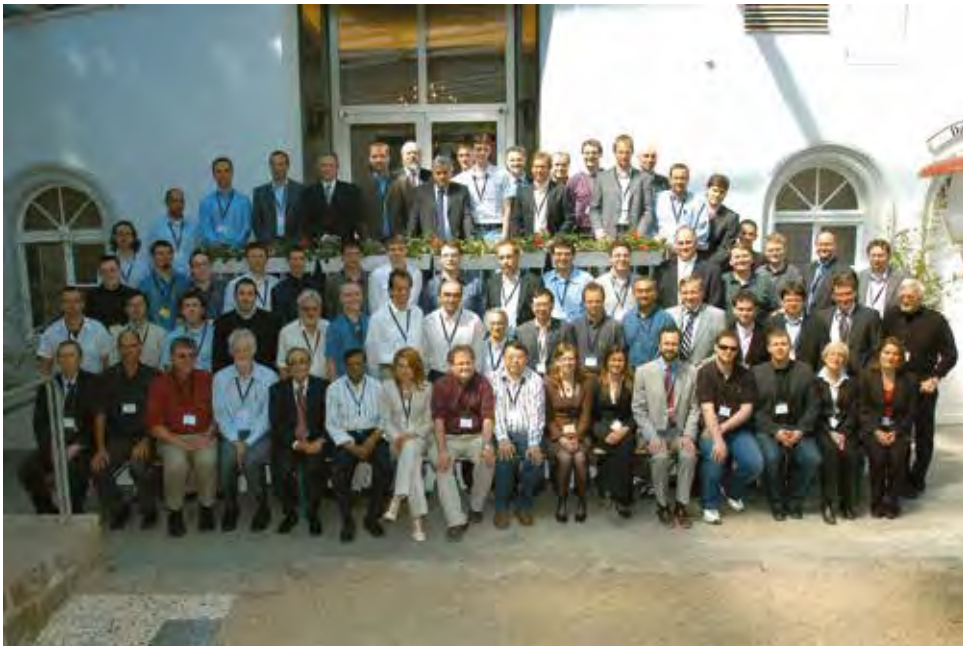

Fig. 4: FEM2008 Workshop, Bonn, Germany, (Group Photo courtesy of Romanus Dyczij-Edlinger).

- *4th International Workshop on Finite Elements for Microwave Engineering - From Electromagnetics to Microwave Electronics Software*
 Poitiers, France, July 10-11, 1998.
 Special issue: P. Guillon, T. Itoh, G. Pelosi, [Eds.], "Finite Elements for Microwave Engineering - From Electromagnetics to Microwave Electronics Software," *International Journal of Numerical Modelling: Electronic Networks, Devices and Fields*, vol. 13, no. 2-3, March-June, 2000. pp. 79-328.
- *5th International Workshop on Finite Elements for Microwave Engineering - Grand Challenges for New Millennium*
 Boston, Massachusetts, USA, June 8-9, 2000.
 A report of this conference, appeared on *IEEE Antennas and Propagation Magazine*, vol. 43, no. 1, 2001, p. 123, is reproduced in the following.
- *6th International Workshop on Finite Elements for Microwave Engineering*
 Chios, Greece, May 29-June 1, 2002.
 Special issue: L. Kempel, C. Balanis [Eds.], "Finite Elements for Microwave Engineering," *Electromagnetics*, vol. 24, no. 1-2, 2004. pp. 1-123.
 A report of this conference, appeared on *IEEE Antennas and Propagation Magazine*, vol. 44, no. 4, 2002, pp. 124-126.
- *7th International Workshop on Finite Elements for Microwave Engineering*
 Madrid, Spain, 20-21 May, 2004.
- *8th International Workshop on Finite Elements for Microwave Engineering*
 Stellenbosch, South Africa, 25-26 May 2006.
 A report of this conference, appeared on *IEEE Antennas and Propagation Magazine*, vol. 48, no. 4, 2006, pp. 110-114, together with an humorous page by Raj Mittra (p. 115), is reproduced in the following.
- *9th International Workshop on Finite Elements for Microwave Engineering*
 Bonn, Germany, 8-9 May 2008.
 Special issue: R. Dyczij-Edlinger, T.F. Eibert [Eds.], "Finite Elements for Microwave Engineering," *Electromagnetics*, vol. 30, no. 1-2, 2010, pp. 1-236.
- *10th International Workshop on Finite Elements for Microwave Engineering*
 Meredith, Massachusetts, USA, 12-13 October 2010.
- *11th International Workshop on Finite Elements for Microwave Engineering*
 Estes Park, Colorado, USA, 4-6 June 2012.
 Special issue: B.M. Notaroš [Ed.], "Finite Elements for Microwave Engineering," *Electromagnetics*, vol. 34, no. 3-4, 2014. pp. 141-362.
 A report of this conference, appeared on *IEEE Antennas and Propagation Magazine*, vol. 55, no. 2, 2013, pp. 204-211, is reproduced in the following.
- *12th International Workshop on Finite Elements for Microwave Engineering*
 Chengdu, China, 14-17 May 2014.
 A report of this conference, appeared on *IEEE Antennas and Propagation Magazine*, vol. 56, no. 4, 2014, pp. 170-176, is reproduced in the following.
- *13th International Workshop on Finite Elements for Microwave Engineering*
 Florence, Italy, 16-18 May 2016.

To remember all these issues, second Chapter of this Part recollects all the call for papers or posters of these editions.

Our highly-focused biennial workshop has provided for 26 years now an ideal meeting place for researchers and practitioners active in the theory and application of the Finite Element Method in RF and microwave engineering. It has attracted a wide and interested audience and reports of the meetings have been published often on the *IEEE Antennas and Propagation Magazine*.

The last Chapter of this Part I reproduces, with the IEEE permission, the exact pages appeared on *IEEE Antennas and Propagation Magazine* with the reports of previous workshops listed above.

NUMERICAL TREATMENT OF THE PLANE TORSION PROBLEM FOR MULTIPLY CONNECTED DOMAINS

Richard L. Courant

Reprinted from: Richard L. Courant "Variational Methods for the Solution of Problems of Equilibrium and Vibration," *Bulletin of the American Mathematical Society*, vol. 49, 1943, pp. 1–23.

APPENDIX⁸NUMERICAL TREATMENT OF THE PLANE TORSION PROBLEM
FOR MULTIPLY-CONNECTED DOMAINS

The computation of the stiffness S defined in §I, 2a furnishes an example of independent interest which permits to compare the practical merits of some of the methods described in this address. Numerical calculations were carried out for the cross sections of the following diagrams, a square from which a smaller square is cut out; and a square, from which four squares are cut out. In the first case our quadratic frame was supposed to be bounded by the lines $x = \pm 1$, $y = \pm 1$ and $x = \pm 3/4$, $y = \pm 3/4$. To apply the Rayleigh-Ritz method for the domain as a whole would already be cumbersome because of the boundary conditions for admissible functions ϕ . However, this difficulty disappears if we exploit the symmetry of the domain and the resulting symmetry of the solution; thus we may confine ourselves to considering only one-eighth of the domain B^* , namely the quadrangle $ABCD$. For this polygon any function of the type

$$\phi = a(1 - x)[1 + (x - 3/4)P]$$

where $P(x, y)$ is a polynomial, is admissible, and its substitution in the integral leads to simple linear equations for the coefficients. Thus for the simplest attempt

$$\phi = a(1 - x)$$

which leaves only one constant a to be determined, we find with a

⁸ Addition not contained in the original address.

negligible amount of numerical labor $S = .339$ and $c = -.11$. A refined attempt with the function

$$\phi = a(1 - x)[1 + \alpha(x - 3/4)y]$$

yielded $S = .340$ and $c = -.109$ with little more labor.

These results were checked with those obtained by our generalized method of finite differences where arbitrary triangular nets are permitted. The diagrams are self-explanatory. Unknown are the

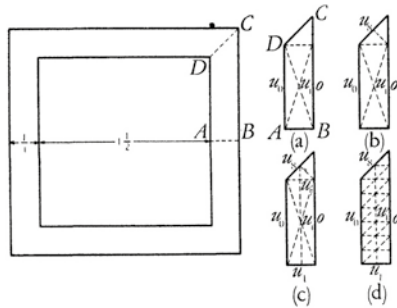

FIG. 2

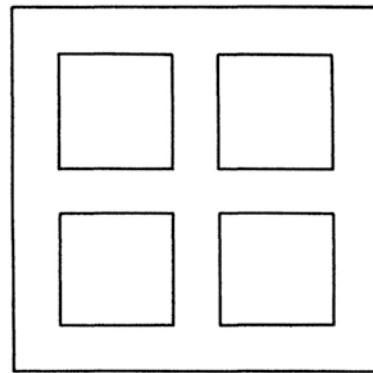

FIG. 3

net-point-values u_i , ($c = u_0$). In the net-triangles our functions were chosen as linear, so that the variational problem results in linear equations for the u_i . The results, easily obtainable, were: case (a) with two unknowns: $S = .344$, $u_0 = -.11$; case (b) with three unknowns: $S = .352$, $u_0 = -.11$; case (c) with five unknowns $S = .353$, $u_0 = -.11$; case (d) with nine unknowns, corresponding to the ordinary difference method $S = .353$, $u_0 = -.11$.

These results show in themselves and by comparison that the generalized method of triangular nets seems to have advantages. It was applied with similar success to the case of a square with four holes, and it is obviously adaptable to any type of domain, much more so than the Rayleigh-Ritz procedure in which the construction of admissible functions would usually offer decisive obstacles.

In a separate publication it will be shown how the method can be extended also to problems of plates and to other problems involving higher derivatives.

Of course, one must not expect good local results from a method

using so few elements. However, it might be expected that a smooth interpolation of the net functions obtained will yield functions which themselves with their derivatives are fairly good approximations to the actual quantities.

REFERENCES

1. R. Courant, *Ueber direkte Methoden bei Variations- und Randwertproblemen*, Jber. Deutschen Math. Verein. vol. 34 (1925) p. 90 ff.; reprinted in Math. Ann. vol. 97 (1927) p. 711 ff.
2. ———, *Ueber direkte Methoden . . .*, Proceedings of the International Congress for Applied Mechanics, Delft, 1925.
3. ———, *Ueber partielle Differenzgleichungen*, Atti del Congresso Internazionale dei Matematici, Bologna, 1928.
4. ———, *Ueber Randwertaufgaben bei partiellen Differenzgleichungen*, Zeitschrift für angewandte Mathematik und Mechanik vol. 6 (1926) p. 1 ff.
5. ———, *Ueber die Theorie der linearen partiellen Differenzgleichungen*, Goettingen Nachrichten, 1925.
6. ———, *Bemerkungen zur numerischen Aufloesung von Randwertproblemen . . .*, Goettingen Nachrichten, 1926, p. 111 ff.
7. ———, *Ueber ein konvergenzerzeugendes Prinzip der Variationsrechnung*, Goettingen Nachrichten, 1922.
8. R. Courant, K. Friedrichs, H. Lewy, *Ueber die partiellen Differenzgleichungen der mathematischen Physik*, Math. Ann. vol. 100 (1928) p. 32 ff.
9. R. Courant and D. Hilbert, *Methoden der mathematischen Physik*, vol. I, 2d edition, 1931; vol. II, 1937.
10. R. Courant, *On a method for the solution of boundary-value problems*, Theodore von Kármán Anniversary Volume, 1941.
11. ———, *On the first variation of the Dirichlet-Douglas integral and on the method of gradients*, Proc. Nat. Acad. Sci. U.S.A. vol. 27 (1941) p. 242 ff.
12. J. Hadamard, *Mémoire sur le problème d'analyse relatif à l'équilibre des plaques élastiques encastrées*, Mémoires présentés par divers savants étrangers à l'Académie des Sciences de l'Institut de France (2) vol. 33, 4 (1908).
13. H. Lewy, *Ueber einen Ansatz zur numerischen Loesung von Randwertproblemen*, Goettingen Nachrichten, 1925, p. 118 ff.
14. Philipps and N. Wiener, *Nets and the Dirichlet problem*, Publication of the Massachusetts Institute of Technology, 1925.
15. R. G. D. Richardson, *A new method in boundary value problems for differential equations*, Trans. Amer. Math. Soc. vol. 18 (1917) p. 489 ff.
16. R. Lueneburg, *Das Problem der Irrfahrt ohne Richtungsbeschaenkung . . .*, Math. Ann. vol. 104 (1931) p. 700 ff.
17. Petrovsky, *Ueber das Irrfahrtenproblem*, Math. Ann. vol. 109 (1934) p. 425 ff.
18. W. Feller, *Zur Theorie der Stochastischen Prozesse*, Math. Ann. vol. 113 (1936) p. 113 ff.
19. C. J. Thorne and J. V. Atanasoff, *A functional method for the solution of thin plate problems . . .*, Iowa State College Journal of Science vol. 14 (1940) p. 333 ff.
20. A. Weinstein, *Etude des spectres des équations aux dérivées partielles de la théorie des plaques élastiques*, Mémoires des Sciences Mathématiques, no. 88, 1937.
21. ———, *On a minimal problem in the theory of elasticity*, J. London, Math. Soc. vol. 10 (1935) p. 184 ff.

FINITE-ELEMENT SOLUTION OF HOMOGENEOUS WAVEGUIDE PROBLEMS

Peter P. Silvester

Reprinted from: P.P. Silvester "Finite-Element Solution of Homogeneous Waveguide Problems," *Alta Frequenza, Rivista di Elettronica*, vol. 38, 1969, pp. 313–317, special issue on URSI meeting.

6-9 FINITE-ELEMENT SOLUTION OF HOMOGENEOUS WAVEGUIDE PROBLEMS

P. SILVESTER (*)

This paper presents a new method of waveguide analysis, which permits finding not only the dominant propagating mode, but also the higher modes, of guides of arbitrary cross-sectional shape. While certain methods have been developed to determine some higher modes in guides of comparatively simple shape, e. g., the rectangular coaxial guide [1] or the lunar guide [2], difficulty is encountered in attempts to extend them to very general cross-sections. On the other hand, finite-difference methods have proved very powerful for finding the dominant modes of complicated guides, but lend themselves ill to the determination of any further propagating modes [3]. The new method therefore fills a significant gap in the range of available analytic techniques.

FINITE-ELEMENT FORMULATION OF THE WAVEGUIDE PROBLEM.

As is well known, the propagating modes of a hollow, uniform, waveguide may be determined by solving the two-dimensional scalar Helmholtz equation

$$(1) \quad (\nabla^2 + k^2) \Pi = 0.$$

Here Π represents the magnitude of an axially directed electric or magnetic Hertz vector. If the transverse electric (TE) modes of the guide are desired, Π must be the electric Hertz vector, and satisfy the homogeneous Neumann boundary condition

$$(2) \quad \frac{\partial \Pi}{\partial n} = 0$$

while the transverse magnetic (TM) modes are obtained if Π is taken to be the magnetic Hertz vector, and subject to the boundary condition

$$(3) \quad \Pi = 0$$

everywhere along the guide walls.

Rather than attempting to solve this eigenvalue problem directly, the new method reframes it in variational terms. It is shown in books on mathematical physics [4] that the solution of the Helmholtz equation with homogeneous boundary conditions is equivalent to minimising the functional \mathcal{F} defined by

$$(4) \quad \mathcal{F} = \iint_R (|\text{grad } \varphi|^2 + k^2 \varphi^2) dx dy$$

The region of integration is, of course, the waveguide cross-section. If a trial solution $\varphi(x, y)$ is represented geometrically as a surface spanning the region R over the $x-y$ plane, the correct surface $\Pi(x, y)$ is that which yields the smallest possible value of \mathcal{F} . One may view \mathcal{F} as a measure of error; among any class of trial surfaces $\varphi(x, y)$, the one that best matches $\Pi(x, y)$ yields the smallest \mathcal{F} . Instead of attempting to find the exact solution surface $\Pi(x, y)$, a particular restricted class of surfaces will now

be considered, and the smallest possible \mathcal{F} among these determined.

In the finite-element method, the correct solution will be approximated to by a surface $\varphi(x, y)$ made up of finite surface elements of a simple kind. Let the region R be subdivided into a number of elementary regions of finite size. For simplicity, all the elementary regions are taken to be polygonal. Corresponding to each elementary region, a surface element will be defined by requiring $\varphi(x, y)$ to be a linear function of its values at the polygon vertices (or, more generally, of a finite number of parameters associated with the elementary region). For a general polygonal elementary region with n vertices, φ is then defined by

$$(5) \quad \varphi(x, y) = \sum_{i=1}^n \alpha_i(x, y) \varphi_i$$

If desired, the finite-element method may be defined in terms of the method of moments [5]; equation (5) is then the definition of a family of multiparameter basis functions.

\mathcal{F} is now no longer a true functional, but an ordinary function of the parameters that define φ , in this case the vertex values φ_i :

$$(6) \quad \mathcal{F}(\varphi) = F(\varphi_1, \varphi_2, \dots, \varphi_N)$$

The best possible set of parameter values, and hence the best possible φ within the class defined by (5), is found by minimising F with respect to all the parameters. That is, it will be required that

$$(7) \quad \frac{\partial F}{\partial \varphi_m} = 0$$

for all m . If the region R contains altogether N vertices, this minimisation requirement changes (4) into a matrix eigenvalue problem of order N , as will be shown next.

THE MATRIX EIGENVALUE PROBLEM.

In view of equation (6), the minimisation requirement (7) is equivalent to

$$(8) \quad \iint_R \frac{\partial}{\partial \varphi_m} |\text{grad } \varphi|^2 dx dy = k^2 \iint_R \frac{\partial}{\partial \varphi_m} \varphi^2 dx dy$$

Differentiating repeatedly, one finds from (5) that

$$(9) \quad \frac{\partial}{\partial \varphi_m} |\text{grad } \varphi|^2 = 2 \sum_{k=1}^N \left(\frac{\partial \alpha_m}{\partial x} \frac{\partial \alpha_k}{\partial x} + \frac{\partial \alpha_m}{\partial y} \frac{\partial \alpha_k}{\partial y} \right) \varphi_k$$

everywhere within an elementary region that abuts on vertex m . Elsewhere, α_m is zero so that the right-hand side

(*) P. SILVESTER - Dr., McGill University, Montreal, P. Q. (Canada).

6-9

vanishes. By carrying out a similar differentiation, one next finds that

$$(10) \quad \frac{\partial}{\partial \varphi_m} (\varphi^2) = 2 \sum_{k=1}^N \alpha_m \alpha_k \varphi_k$$

where again nonzero terms arise on the right-hand side only if both vertices m and k are vertices of the elementary polygon in question.

It will be convenient to define the purely geometric quantities

$$(11) \quad S_{mk} = \iint_R \left(\frac{\partial \alpha_m}{\partial x} \frac{\partial \alpha_k}{\partial x} + \frac{\partial \alpha_m}{\partial y} \frac{\partial \alpha_k}{\partial y} \right) dx dy$$

and

$$(12) \quad T_{mk} = \iint_R \alpha_m \alpha_k dx dy$$

which express the nature of the region R , and the manner of its subdivision into elementary regions. In terms of these integral quantities, equation (8) reads

$$(13) \quad S \Phi = k^2 T \Phi$$

where Φ is the column matrix of vertex values φ_i ; S and T are square matrices of order N , whose elements are S_{mk} and T_{mk} as defined above. Minimisation of \mathcal{F} is thus equivalent to the eigenvalue problem (13), and solution of the latter will provide approximate eigenvalues and eigenfunctions for the boundary-value problem. It will be noted that S and T are always symmetric, and the eigenvalues therefore always real.

MATRICES S AND T FOR TRIANGULAR ELEMENTS.

While it is possible in principle to consider any shape of polygonal elementary regions, it is most convenient to keep the algebraic details simple by restricting the elementary regions, and therewith the solution surface elements, to be triangular. The logical choice of linear functions in equation (5) is then such as to make the value of φ anywhere within an elementary region simply the linear interpolate of its vertex values [6]. Geometrically, the true solution surface is now to be approximated by a surface $\varphi(x, y)$ consisting of triangular flats. It should be noted that this approximation forms a continuous surface throughout the region.

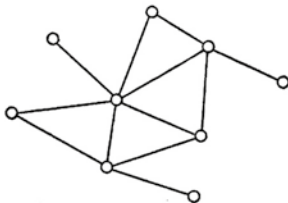

Fig. 1. — Subdivision of region R into triangular elementary regions.

Consider now a triangular elementary region with vertices numbered 1, 2, 3, as in fig. 1. The value of φ for all x, y within the triangle is given by

$$(14) \quad \varphi = \frac{1}{2A} \sum_{j=1}^3 (a_j + b_j x + c_j y) \varphi_j$$

where A represents the triangle area. It can be shown [6] that the three coefficients that result in linear interpolation over the triangle are

$$(15) \quad a_j = \begin{vmatrix} x_{j+1} & y_{j+1} \\ x_{j+2} & y_{j+2} \end{vmatrix}$$

$$(16) \quad b_j = y_{j+2} - y_{j+1}$$

$$(17) \quad c_j = x_{j+1} - x_{j+2}$$

the subscripts being cyclic modulo 3.

For ease in both analysis and computer programming, it is useful to regard the matrices S and T as being composed of sums of sparse matrices of order N , typically $s^{(i)}$ and $t^{(i)}$, made up of the contributions to the S and T matrices that are attributable to only one elementary region, say the i^{th} . That is to say, one may write

$$(18) \quad S_{mk} = \sum_n s_{mk}^{(n)}$$

$$(19) \quad T_{mk} = \sum_n t_{mk}^{(n)}$$

Clearly $s_{mk}^{(n)} = t_{mk}^{(n)} = 0$ whenever n equals neither m nor k , i. e., for all elements which touch neither vertex m nor k . Explicit expressions for the element matrix components are

$$(20) \quad s_{mk}^{(i)} = \iint_i \left(\frac{\partial \alpha_m}{\partial x} \frac{\partial \alpha_k}{\partial x} + \frac{\partial \alpha_m}{\partial y} \frac{\partial \alpha_k}{\partial y} \right) dx dy$$

$$(21) \quad t_{mk}^{(i)} = \iint_i \alpha_m \alpha_k dx dy$$

the integrations being carried out over the i^{th} elementary region. For triangular elementary regions, $s^{(i)}$ and $t^{(i)}$ in general possess nine nonzero components, and are symmetric. These component values are found by substituting (14) into (20):

$$(22) \quad s_{mk}^{(i)} = \frac{1}{4A^2} \iint_i (b_m b_k + c_m c_k) dx dy.$$

On carrying out the necessary integration,

$$(23) \quad s_{mk}^{(i)} = \frac{1}{4A} [(x_m - x_i)(x_k - x_i) + (y_m - y_i)(y_k - y_i)]$$

Similarly, substitution into (21) yields

$$(24) \quad t_{mk}^{(i)} = \frac{1}{4A^2} \iint_i (a_m + b_m x + c_m y) \cdot (a_k + b_k x + c_k y) dx dy.$$

After a lengthy integration, one obtains the surprisingly simple result

$$(25) \quad t_{mk}^{(i)} = \begin{cases} \frac{1}{12} A, & m \neq k \\ \frac{1}{6} A, & m = k \end{cases}$$

Leaving out all rows and columns composed of zeros only,

a single triangular element is thus described by the matrix contributions

$$(26) \quad \begin{bmatrix} s_{11} & s_{12} & s_{13} \\ s_{21} & s_{22} & s_{23} \\ s_{31} & s_{32} & s_{33} \end{bmatrix} \begin{bmatrix} \varphi_1 \\ \varphi_2 \\ \varphi_3 \end{bmatrix} = k^2 \frac{A}{12} \begin{bmatrix} 2 & 1 & 1 \\ 1 & 2 & 1 \\ 1 & 1 & 2 \end{bmatrix} \begin{bmatrix} \varphi_1 \\ \varphi_2 \\ \varphi_3 \end{bmatrix}$$

where the s_{mk} are calculated from (23), and the area A is given by

$$(27) \quad A = \frac{1}{2} |(y_m - y_i)(x_k - x_i) - (y_k - y_i)(x_m - x_i)|.$$

COMPARISON OF FINITE-ELEMENT AND FINITE-DIFFERENCE METHODS.

Were the waveguide problem to be solved by a finite-difference instead of finite-element method, one would subdivide the region R by a suitable mesh, most commonly regular and square. Further subdivision of the mesh into triangles by means of added lines but without adding new mesh-points, is always possible, and permits alternative treatment by the above finite-element method. A direct comparison of the two techniques can then be made.

In the finite-difference method, the Helmholtz equation is replaced by the matrix equation

$$(28) \quad S \Phi = k^2 \Phi.$$

The matrix S arises from discretisation of the Laplacian operator, and closely resembles the matrix S defined above. In fact, if the boundary conditions are of Dirichlet type, the matrices S in (13) and (28) are always identical; in the case of Neumann boundaries, it depends on which of the several possible methods of boundary treatment is employed in the finite-difference approach. However, the matrix T in equation (13) is replaced by the unit matrix in equation (28). It can be shown that this replacement is physically equivalent to replacing distributed sources by point sources located at the mesh-points. Therefore equation (13) seeks to establish a least-squares fit to the solution surface, while (28) requires a solution surface consistent with its own point-source replacement. One is thus led to the unexpected conclusion that the weakness of the usual finite-difference method lies not in its relatively crude modelling of the Laplacian operator, as is sometimes thought, but rather in its inaccurate discretisation of the identity operator. Considerable support is lent to this view by the numerical results reported below, which show that the finite-element method provides by far the more accurate results for any given number of points.

A GENERAL COMPUTER PROGRAMME.

The procedure described above has been implemented in a computer programme coded in Fortran IV language. Typical running times of this programme are about 1-2 minutes, using an IBM 7090 computer (32K word memory).

Assembly of the matrices S and T constitutes the first, and most important, section of the programme. The input consists of a description of the waveguide cross-section, in the form of a listing of triangle vertex coordinates followed by an incidence listing which identifies the connections to be made between triangle vertices. Ordinarily, 50-100 vertices suffice to provide useful results for most guide cross-sections. Consequently both S and T can be stored in im-

mediate-access memory concurrently, and subsequent matrix operations can be performed by explicit rather than iterative methods. The assembly of S and T typically occupies about 10 seconds of machine time.

From (26), S is always nonnegative definite and T always positive definite. It is therefore possible to perform a Choleski decomposition on T ,

$$(29) \quad L L' = T$$

where L is a positive definite lower triangular matrix. Inversion of L , and subsequent multiplication, then convert (13) into the form

$$(30) \quad (L^{-1} S L^{-1'}) (L' \Phi) = k^2 (L' \Phi).$$

This is an eigenvalue problem in its standard form. It is worth noting that Choleski decomposition, instead of inversion, of T is necessary to guarantee symmetry of the final matrix.

The actual solution of the eigenvalue problem uses techniques which may be regarded as standard. Tridiagonalisation is first performed, using the Householder transformation algorithm, and eigenvalues sought by the bisection method, employing Wilkinson's modified Sturm sequences [7]. Eigenvectors are determined by Wielandt iteration, and transformed back to find the desired Φ . No computational difficulty is encountered in locating as many eigenvalues as are thought desirable or physically meaningful. Neumann boundaries do not give rise to any special problems; the bisection method produces the redundant zero eigenvalue, of course, but it is only necessary to ignore it.

MODES OF A CIRCULAR WAVEGUIDE.

In order to assess the efficacy of the new method, some rectangular and circular waveguides were investigated. The circular cross-section was subjected to a lengthy series of numerical experiments whose most important

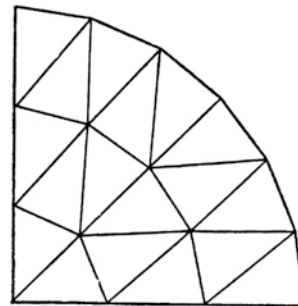

Fig. 2. — 18-element model of one quadrant of a circular waveguide

results are summarised here. These experiments sought to determine the accuracy to which the first sixteen modes (eighteen, counting degeneracies) of a circular guide could be determined. The E_{31} mode (the eleventh most important) was omitted from consideration, in order to permit modelling the guide cross-section by only one quadrant. Meshes of the type shown in fig. 2 were employed. These were generated by computer, and fitted to the circular boundary so as to produce the correct enclosed area. Although the elementary regions are all roughly equilateral, their precise shapes and sizes vary so as to permit accurate fitting to the given boundaries.

6-9

The table below exhibits the cutoff wavelengths, normalised to unit guide radius, for several levels of approximation, and compares them with the known exact solution. The eigenvalues are found, in effect, as Rayleigh quotients in appropriate subspaces, so one would expect the computed cutoff wavelengths to represent lower bounds; examination of the table shows that this indeed appears to be so. It is also seen that the error varies essentially inversely with the number of elementary regions used. As a consequence, extrapolation can be used to improve the cut-off wavelengths so as to achieve very high accuracies indeed.

Tabulated cutoff wavelengths below should be compared with the results given by Davies and Huilwyk [3] for their solution of the same problem (for the dominant modes only) by finite differences. The maximum number of vertex points used in the present method was 100, as compared with about 10,000 for finite-difference work reported by the latter authors. However, the inherent accuracy of the finite-element technique is obviously higher; the error in cutoff wavelength of the H_{11} and E_{01} modes achieved by finite differences, using roughly the same amount of immediate-access storage and about the same length of computer time, is higher than that resulting from finite-element analysis. One is therefore inclined to conclude that the finite-

element method is to be preferred. It is highly competitive for the dominant modes, and produces in addition a number of higher modes, with no extra programming effort and virtually no extra computing time.

Figures 3-4 show two modal patterns generated for the circular guide, subdivided into 50 triangular elements per quadrant. This comparatively crude model illustrates clearly, if somewhat exaggeratedly, the essential characteristics of finite-element solutions. The contour lines of each solution surface are composed of straight-line segments, as would be expected from a surface consisting of flat facets.

The mode plots shown here are of course much more crude than those obtainable with a finer subdivision. In fact, subdivision into 162 elementary regions per quadrant produces contour lines almost indistinguishable from smooth curves, especially for the lower-order modes. With increasing mode number, the complexity of the solution surface grows, and plots in all cases present an increasingly ragged appearance.

SOLUTION OF DIFFICULT WAVEGUIDE PROBLEMS.

The general programme described above is immediately usable for analysis of waveguides of nearly any shape, and

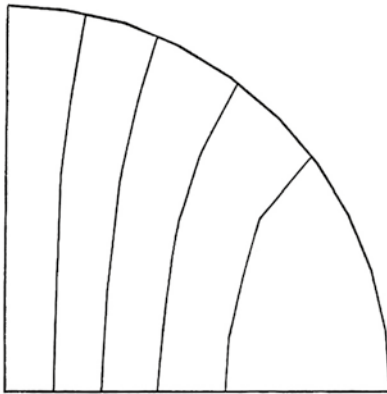

Fig. 3. — Round guide modelled by 50 elements, H_{11} mode.

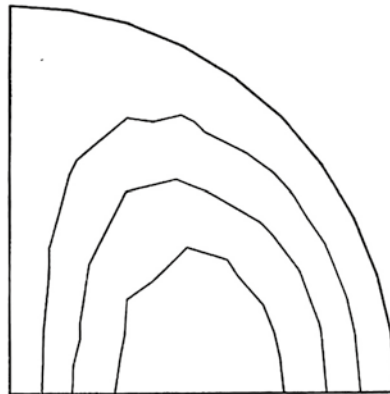

Fig. 4. — Round guide modelled by 50 elements, E_{11} mode.

Calculated Cutoff Wavelengths of a Circular Waveguide.

Mode	Number of elements in one waveguide quadrant							Exact
	18	32	50	72	98	128	162	
H_{11}	3.3564	3.3915	3.3991	3.4032	3.4056	3.4073	3.4083	3.4129
E_{01}	2.5773	2.6002	2.6044	2.6069	2.6084	2.6094	2.6100	2.6125
H_{21}	1.9977	2.0286	2.0388	2.0439	2.0473	2.0496	2.0511	2.0574
H_{01}, E_{11}	1.5452	1.5899	1.6097	1.6183	1.6230	1.6269	1.6296	1.6397
H_{31}	1.4251	1.4580	1.4707	1.4780	1.4825	1.4855	1.4875	1.4956
E_{21}	1.1102	1.1598	1.1813	1.1938	1.2015	1.2065	1.2100	1.2234
H_{41}	1.1156	1.1428	1.1473	1.1574	1.1674	1.1706	1.1728	1.1817
H_{12}	1.0394	1.0988	1.1265	1.1417	1.1513	1.1575	1.1619	1.1786
E_{02}	1.0285	1.0755	1.0968	1.1086	1.1162	1.1212	1.1246	1.1383
H_{51}	0.8891	0.9264	0.9436	0.9540	0.9604	0.9647	0.9677	0.9793
H_{22}	0.7881	0.8470	0.8761	0.8941	0.9050	0.9122	0.9173	0.9369
H_{02}, E_{12}	0.7538	0.8023	0.8350	0.8540	0.8618	0.8695	0.8748	0.8955
H_{61}	0.7397	0.7783	0.7943	0.8088	0.8160	0.8208	0.8242	0.8376
E_{41}	0.7003	0.7499	0.7715	0.7907	0.8002	0.8065	0.8109	0.8280
H_{32}	0.6373	0.6849	0.7163	0.7353	0.7475	0.7556	0.7614	0.7839
E_{22}	0.5843	0.6437	0.6760	0.6771	0.7077	0.7163	0.7224	0.7465

requires only the preparation of an appropriate data deck for each cross-section. To verify the correct functioning of the programme, a rectangular coaxial guide was analysed, for which there exist solutions based on orthonormal block analysis [1, 8]. Fig. 5 shows one of the two fundamental TE modes of such a guide, and again exhibits the characteristic piecewise-linear behaviour of contour lines. This pattern was calculated using a partly machine-generated subdivision mesh consisting of equilateral triangles over most of the guide cross-section, and odd-shaped triangles near the edges where the boundary lines are represented

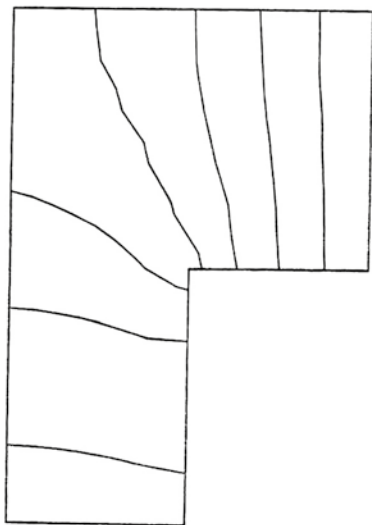

Fig. 5. — One quadrant of a rectangular coaxial guide, H_{11} mode in Bräckelmann's nomenclature.

exactly. The cutoff frequencies for this guide agree with those of Bräckelmann [1] to the accuracy to which the given curves can be read.

Other guide shapes have been investigated by means of the technique described, for example the T -septate lunar cross-section. Not surprisingly, the accuracies obtained vary with the nature of the cross-section, being generally lower where re-entrant corners and sharp edges are encountered, and higher where the cross-sectional shape is essentially convex. In all cases, accuracy has been comparable to what can be achieved by finite-difference methods with the same computational effort.

CONCLUSIONS.

A new method for analysing hollow uniform waveguides has been developed. This method permits determination of the propagating modes with sufficient accuracy for most practical purposes; in contrast to finite-difference techniques, to which it bears a certain resemblance, it produces the higher-order as well as the dominant propagating modes.

Numerical experiments have shown that the new method is capable of accuracy similar to that obtained by finite differences, assuming comparable computational facilities. The accuracy deteriorates with increasing mode order, limiting the number of useful modes to about 10-20 where no symmetries exist, or 20-50 where computational advantage can be taken of symmetry. It is believed that this number is adequately large to permit solution of various waveguide problems involving the higher modes. A distinctive feature of the new method is that the mode patterns are uniquely defined for all points of the guide cross-section, and not only for a discrete set of "sampling" points.

ACKNOWLEDGMENTS.

The author wishes to thank Professor J. Brown, Department of Electrical Engineering, Imperial College of Science and Technology, for provision of research facilities. The work was supported financially in part by the National Research Council of Canada.

REFERENCES

- [1] W. BRÄCKELMANN: *Wellentypen auf der Streifenleitung mit rechteckigem Schirm*. - «Archiv der elektr. Übertragung», 21, 1967, pp. 641-648.
- [2] H. H. MEINKE, W. BAIER: *Die Eigenschaften von Hohlleitern allgemeineren Querschnitts*. - «Nachrichtentechn. Zeitschr.», 19, 1966, pp. 662-670.
- [3] J. B. DAVIES, C. A. MULLWYK: *Numerical solution of uniform hollow waveguides with boundaries of arbitrary shape*. - «Proceedings I.E.E.», 113, 1966, pp. 277-284.
- [4] P. M. MORSE, H. FESHBACH: *Methods of theoretical physics* (Part I). New York: McGraw-Hill 1953.
- [5] R. F. HARRINGTON: *Field computation by moment methods*. - New York: Macmillan 1968.
- [6] O. C. ZIENKIEWICZ, Y. K. CHEUNG: *Finite elements in the solution of field problems*. - «The Engineer», 1965, pp. 507-510.
- [7] W. BARTH, R. S. MARTIN, J. H. WILKINSON: *Calculation of the eigenvalues of a symmetric tridiagonal matrix by the method of bisection*. - «Numerische Mathematik», 9, 1967, pp. 386-393.
- [8] L. GRUNER: *Higher-order modes in rectangular coaxial waveguides*. - «I.E.E.E. Transact. on Microwave Theory and Tech.», MTT-15, 1967, pp. 483-485.

FINITE ELEMENTS IN ELECTRICAL ENGINEERING: THE FIRST 50 YEARS

Peter P. Silvester

Reprinted from: Peter P. Silvester "Finite Elements in Electrical Engineering: The first 50 Years,"
Manuscript in the Proceedings of the *Giornata di studio su Il metodo degli elementi finiti nelle applicazioni
dell'elettromagnetismo [National Workshop on Finite Elements as Applied to Electromagnetics]*
San Miniato (Pisa), May, 26–27, 1992.

1. The Beginnings

When Courant prepared the text of his 1942 address to the American Mathematical Society for publication [1], he added a two-page Appendix to illustrate how the variational methods first described by Lord Rayleigh [2] could be put to wider use in potential theory. Choosing piecewise-linear approximants on a set of triangles which he called "elements", he dashed off a couple of two-dimensional examples and the finite element method was born.

Finite element methods remained dormant, perhaps waiting for computers to be invented, for more than a decade. They next appeared in the work of Duffin [3,4] in a form similar to that given by Courant but relying also on the mathematical ideas of Synge [5]. Variational methods were not then a part of most engineers' mathematical equipment, and the relaxation methods of Southwell [6] had been so successful that where variational methods were used at all by applied field analysts, they were viewed as ways of generating finite difference formulae [7].

Finite element activity in electrical engineering began in earnest about 1968-1969. A paper on waveguide analysis [8] was published in *Alta Frequenza* in early 1969, giving the details of a finite element formulation of the classical hollow waveguide problem. It was followed by a rapid succession of papers on magnetic fields in saturable materials [9], dielectric loaded waveguides [10], and other well-known boundary value problems of electromagnetics. The method was quickly applied to integral operators as well, both in electrostatics [11] and wire antenna problems [12].

In the decade of the eighties, finite element methods spread quickly. In several technical areas, they assumed a dominant role in field problems. An assessment of the finite element literature, and of its growth rate, may be obtained by examining the INSPEC bibliographic data base over the 1970-1990 period. In 1970 the number of extant finite element papers with electrical engineering content amounted to a mere handful. By 1990 the total had reached 5000, with 600 or more additional papers published annually.

¹ All correspondence regarding this manuscript should be directed to: Dr. Peter P. Silvester, Department of Electrical Engineering, McGill University, 3480 University Street, Montreal, Canada H3A 2A7. Telephone (514) 398-7128, fax 398-4470, e-mail 73020.2647@compuserve.com.

Finite elements: The first 50 years

Silvester

The number of papers added to the literature each year, as recorded by the INSPEC data base², is shown in Fig. 1.

Having initiated the method, mathematicians at first failed to grasp the significance of finite elements to practical analysis. Serious attention began to be paid to this technique about the same time as it gained a foothold in electrical engineering. Zlámal [13] published the first mathematical paper explicitly devoted to finite element method about the same time as electrical engineers began to use it seriously. He and Whiteman [14] recognized the mathematical significance of this technique at an early date. Other able mathematicians, such as Ciarlet, [15] quickly followed.

2. Theoretical basis

The mathematics of finite elements initially appeared to be no more than an interesting though simple application of variational calculus. Over the years, however, it has developed into a distinctive field of study encompassing a much broader range of material. This survey is principally directed to electromagnetics so a detailed treatment of the mathematics would be inappropriate. However, a brief overview will clarify why and where electrical engineers have encountered difficulties.

2.1. Strong and weak solutions

The finite element method as used in electromagnetics is a special case of a general mathematical method [16] in which the differential or integral equation to be solved

$$\mathcal{P}u = v \quad (1)$$

is first replaced by an equivalent *weak form*, and this weak-form equation is subsequently solved by numerical approximation. The operator \mathcal{P} may represent a boundary value problem (differential equation plus boundary conditions) or an integral operator, or a mixed (integrodifferential) operator. The principles of treatment are the same, but the details — and the practical difficulties — are different for the differential and integral operators.

In the language of functional analysis, u is said to satisfy the operator equation (1) if $\mathcal{P}u$ and v , the left and right sides of (1), have equal inner product projections onto the range space V of the operator \mathcal{P} . In other words: u is the strong (i.e., exact) solution of (1) if

$$\langle \mathcal{P}u, z \rangle = \langle v, z \rangle, \quad \forall z \in V. \quad (2)$$

A *weak solution* \bar{u} is obtained if $z \in W$, where W is a space of functions whose closure is the range V of the operator \mathcal{P} ,

$$\langle \mathcal{P}\bar{u}, z \rangle = \langle v, z \rangle, \quad \forall z \in W. \quad (3)$$

The weak reformulation permits good approximate solutions to be constructed, for which a considerable amount of convergence theory and error theory exists. It is often numerically more tractable than the original equation, and particularly convenient if the inner product $\langle a, b \rangle$ is an energy product or a product integral [17]. The general principle is to choose a finite-dimensional subspace $W_N \subset W \subset V$ and to solve the finite-

² No data base can cover all of the electrical engineering literature, but it is likely that the portion not indexed by INSPEC is compensated, more or less, by inclusion of marginal material (e.g., bioelectricity or semiconductor thermal process modeling).

Finite elements: The first 50 years

Silvester

dimensional (subspace) version of (3) in W_N . The examples to follow seek to clarify why and how.

2.2. Boundary-value problems.

The finite element method was first applied to boundary-value problems of differential equations, and it may be best to illustrate the procedure by considering a specific case. Fig. 2 shows a mixed boundary value problem, in which

$$\nabla^2 u = v \quad \text{in } \Omega, \quad (4)$$

$$u = 0 \quad \text{on } \partial_D, \quad (5)$$

$$\frac{\partial u}{\partial n} = 0 \quad \text{on } \partial_N. \quad (6)$$

Its solution u lies in a Hilbert space whose inner product is conveniently defined as the simple product integral

$$(a, b) = \int_{\Omega} ab \, d\Omega. \quad (7)$$

The weak solution is derived by taking inner products with some function w on both sides,

$$\int_{\Omega} w \nabla^2 u \, d\Omega = \int_{\Omega} wv \, d\Omega \quad \text{in } \Omega, \quad (8)$$

then applying Green's second identity to the left-hand member. There results the pair of equations

$$\int_{\Omega} \nabla w \cdot \nabla \bar{u} \, d\Omega = - \int_{\Omega} wv \, d\Omega \quad (9)$$

$$\oint_{\partial\Omega} w \nabla \bar{u} \cdot d\mathbf{S} = 0, \quad \partial\Omega = \partial_N \cup \partial_D. \quad (10)$$

Here an integral over the entire problem domain Ω takes the place of the original differential equation, and an integral over the region boundary replaces the normal-derivative boundary condition. Green's second identity provides no integral statement to correspond to the Dirichlet boundary condition $u = 0$; consequently, this condition must be explicitly imposed in the process of approximate solution. Once it is applied, however, the surface integral (10) corresponding to the Neumann boundary condition appears naturally in the weak formulation. Consequently the Neumann boundary condition of Equation (6) is termed a *natural* boundary condition, while the Dirichlet boundary condition of Equation (5) is termed *principal*. Because many boundary value problems of electromagnetics can be framed in terms of wave or potential equations, to which such integrations by parts are applicable, natural boundary conditions arise frequently.

The integration by parts introduced through Green's second identity reduces the continuity requirements on \bar{u} ; at the same time it places stronger continuity requirements on w than on v . The weak solution \bar{u} need only belong to the space C^0 of continuous functions whereas u clearly must lie in C^1 , i.e., it must be twice differentiable. Conversely, w must be at least once differentiable while v in the original differential equation (4) need not even be continuous. Thus the weak solution may be sought in the space W (whose closure is V) with the following characteristics:

Finite elements: The first 50 years

Silvester

$$\bar{u} \in W \quad \text{if and only if} \quad \begin{aligned} \bar{u} &\in C^0, \\ \bar{u} &= 0 \text{ on } \partial_D. \end{aligned}$$

The weakened continuity requirement on u (which incidentally accounts for the strange name *weak form*) is useful because it makes construction of numerical methods comparatively easy: an approximate solution \tilde{u} can now be sought in the space of all square-integrable functions with the reduced continuity conditions. The key point is that the weak formulation refers to the same space W for both range and domain, while in the strong formulation the domain and range of \mathcal{P} are radically different.

2.3. Finite element methods.

To obtain an approximate weak solution $\tilde{u} \simeq \bar{u}$, the problem region Ω is partitioned into a set of nonoverlapping, simply connected *finite elements* Ω_i ,

$$\Omega = \bigcup_i \Omega_i, \quad (11)$$

A finite set $\{\alpha_k \mid k=1, \dots, N\}$ of approximating functions is defined to span W_N , a subspace of W . It is usual, though not necessary, to use polynomials defined on an element-by-element basis. To obtain a valid approximate solution, the approximating functions must be constructed so as to guarantee as high a degree of continuity as the weak form requires, and to satisfy all the principal boundary conditions. In the example, it is thus required that (1) $\alpha_k \in C^0$, and (2) $\alpha_k = 0$ on ∂_D . A great part of the literature of finite elements deals with systematic methods for partitioning Ω into elements and generating approximating functions on them. One popular method is to construct interpolation functions so that the function values on the edges of each element will match the function values along the edge of the adjoining element. The reduced continuity requirement of the weak form is valuable here, for it is difficult to construct approximating functions to be twice (or even more) differentiable, but achieving continuity of function value is relatively easy. Similarly, imposing derivative values at boundaries is much harder than imposing function values, so the natural boundary conditions that accompany the weak forms again lighten the task. The comparative ease of constructing approximating functions to possess the required low degrees of continuity in geometric regions of complicated shape is indeed the key to success of the finite element method.

Once the finite element function space W_N has been constructed, the weak solution is approximated by the finite summation

$$\tilde{u} = \sum_k^N u_k \alpha_k. \quad (12)$$

Equation (9) then becomes

$$\sum_k^N \int_{\Omega} \nabla \alpha_j \cdot \nabla \alpha_k d\Omega u_k = - \int_{\Omega} \alpha_j v d\Omega. \quad (13)$$

Since the integrals can be evaluated immediately, this may be regarded as a matrix equation in the standard form

$$\sum_k^N S_{j,k} u_k = -v_j, \quad (14)$$

and solved by the usual methods of numerical linear algebra. The equation solution is usually the most expensive phase of computation, so a considerable amount of effort has been devoted to the development of methods able to exploit such peculiar properties as the matrix S may possess in any particular kind of problem.

Although reduced differentiability requirements are a major reason for the success

of finite elements, they are not in themselves a *sine qua non* ingredient. The crucial point is rather that the approximate solution \tilde{u} is sought in a larger function space than the range of the operator \mathcal{P} of the strict differential equation formulation, a function space capable of accommodating both range and domain of \mathcal{P} .

2.4. Integral operators.

Integral equations, i.e., problem formulations in which \mathcal{P} is an integral operator, allow construction of weak-form equivalents in precisely the same way as boundary-value problems, and lead to symmetric range and domain spaces in the same way. However, an integration by parts is not now available; indeed it is not even necessary because differentiability is not the issue. Instead, the enlarged space in which the solution is to be sought is characterized by different integrability requirements. Consider, for example, the integral equation that describes the electrostatic potential u near a microstrip line as shown in Fig. 3(a),

$$u(P) = \int_{\Omega} G(P;Q) \rho(Q) d\Omega_Q, \quad (15)$$

where $G(P;Q)$ is the appropriate Green's function [18], i.e., the potential at point P due to a unit charge at point Q , and $\rho(Q)$ is the charge density at point Q . This function is known to be symmetric in P and Q , and to have a logarithmic singularity at $P = Q$. Just as in the boundary value problem given above, of the range and domain of the integral operator have quite different smoothness characteristics; but they are inverted, with the range functions exhibiting greater differentiability than the domain.

A symmetric representation is obtained in much the same way as for boundary value problems, by taking inner product projections of both sides of (15) onto a function space W , with an inner product defined in a similar way. There results

$$\int_{\Omega} u(P) w(P) d\Omega_P = \int_{\Omega} \int_{\Omega} G(P;Q) \bar{\rho}(Q) w(P) d\Omega_Q d\Omega_P. \quad (16)$$

Because the expressions are exactly symmetric in P and Q , the integrability requirements on u , $\bar{\rho}$ and w are similar. Furthermore, they are weaker than the requirements applicable to ρ , though this fact has not been exploited very extensively. For the general theory to be applicable, W must be a Hilbert space under the inner product definition given — i.e., all functions must be square integrable — and its closure must be the domain (not the range, in contrast to boundary value problems) of the integral operator. Under this restriction, a numerical solution process can be constructed that precisely parallels that applicable to the boundary value problem. Subdivision into finite elements is done similarly, but the choice of finite approximating functions is a great deal easier, for the members of W are subject to no continuity requirement at all. In the present case, the task borders on the trivial, for as shown in Fig. 3(b), the finite elements are one-dimensional. This reduction in dimensionality occurs in most problems involving linear materials only, and the resulting finite elements are for this reason sometimes known as *boundary elements*.

Strictly speaking, it is not essential to approximate $\bar{\rho}$ and u with the same functions; it is permissible to choose $\bar{\rho}$ from some N -dimensional space $W_N^{(\rho)} \subset W$ and u from some other N -dimensional space $W_N^{(u)} \subset W$. However, both must be subspaces of W for the extensive approximation theory now available to apply [19]. In particular, delta functions are not square integrable and therefore cannot be used to build finite elements. They are useful, on the other hand, for establishing collocation methods.

Harrington [20] has made a considerable but unsuccessful effort to unify finite element methods and collocation methods into a single whole. Both techniques have been used extensively in electromagnetics, and both have been referred to as the *method of*

Finite elements: The first 50 years

Silvester

moments by microwave engineers. Because these two represent two different classes of method, and do not fit within the same mathematical framework, it may be best to eliminate confusion by avoiding the term *method of moments* altogether. Collocation, also known as *point matching*, is perhaps best viewed as the integral-equation version of finite differences. It might be noted that much effort was also expended in unsuccessful attempts to unify finite difference and finite element methods into a single technique, particularly in the late sixties and early 1970s.

3. Element types

Finite elements used for electromagnetics problems in the early days of the art resembled those used in structural mechanics. The differences in the underlying physical problems rapidly led to the development of distinctive element types. It is probably fair to say that almost all work in electromagnetics has used distinctive elements since about 1970. There are basic distinctions between the elements used in scalar and vector problems, as well as between those of spatially infinite or finite extent. The major classes of approximating function and of geometric shape as commonly used in electromagnetics are surveyed in the following.

3.1. Scalar Lagrangian simplexes

Problems stated in terms of scalar potentials or wave functions have been routinely solved for more than two decades now, using a family of functions based on Lagrangian interpolation polynomials. In general, a family of interpolation polynomials $\psi_i(P)$ on some finite element Ω is associated with a point set $P: \{P_i | P_i \in \Omega, i = 1, \dots, K\}$ such that

$$\psi_i(P_j) = \delta_j^i, \quad (17)$$

where δ_j^i is the Kronecker delta. Finite element approximating functions are most often chosen to be interpolation polynomials. This approach has some computational advantages, and has the esthetically pleasing aspect that all computed numbers represent physically like quantities — potentials, wave functions, or whatever the problem may require. On the finite element Ω of Fig. 4(a), for example, the function ϕ is modeled by

$$\phi(P) = \sum_i \phi(P_i) \psi_i(P), \quad (18)$$

so the coefficient that accompanies ψ_i is the value of ϕ at point P_i .

Interpolation polynomials useful as finite element approximating functions are defined on an element-by-element basis and must satisfy continuity requirements at element boundaries. Suppose the boundary ∂_{ij} is shared by elements Ω_i and Ω_j used to model some scalar function ϕ , as in Fig. 4(b). Function continuity is obtained if the function value at every interface point is determined entirely by the nodal values on that interface. Hence

$$\phi(P) = \sum_k \phi(P_k) \bar{\psi}_k(P), \quad P \in \partial_{ij}, P_k \in \partial_{ij}, \quad (19)$$

where $\bar{\psi}_k$ are the functions into which the ψ_k degenerate on the interface ∂_{ij} , and also interpolation functions in their own right on that surface. As is readily seen in Fig. 4(b), this requirement places some constraints on how the interpolation polynomials are defined, for the same argument can be applied recursively for elements of high dimensionality. For example, along the (one-dimensional) edge between two-dimensional

*Finite elements: The first 50 years**Silvester*

elements of Fig. 4(b), the approximated function ϕ is a cubic polynomial in the distance s along the edge; the three coefficients of this cubic function are determined by the four nodal potential values associated with the edge.

A complete polynomial basis of degree n — one that spans all polynomials of degree n or lower, but contains no terms of order higher than n — has exactly $N(d,n)$ members,

$$N(d,n) = \prod_{i=1}^d \frac{n+i}{i}, \quad n \geq 0, d \geq 1, \quad (20)$$

$$N(0,n) = 1.$$

This assertion is readily verified by counting the number of linearly independent monomials in d variables. With $d = 2$, for example, the first few monomial sets are $\{1\}$, $\{1, x, y\}$, $\{1, x, y, x^2, xy, y^2\}$, $\{1, x, y, x^2, xy, y^2, x^3, x^2y, xy^2, y^3\}$. A two-dimensional finite element must possess $N(1,n)$ nodes along each edge, in order to provide interelement continuity at edges; a three-dimensional element must possess $N(2,n)$ nodes on each face (including the edge nodes) and $N(1,n)$ nodes along each edge. Additional nodes may be admissible in some circumstances. This set of rules is satisfied by a family of *simplex* elements — lines, triangles, and tetrahedra — because each d -dimensional simplex is bounded by $d+1$ simplexes of dimensionality $d-1$. For example, a tetrahedron is bounded by four triangles. Interpolation functions for these elements are readily derived by an extension into d dimensions of the Newton-Cotes theory of interpolative quadrature [21]. The interpolation nodes are placed on the element in a regular array, as in Fig. 4(a). The corresponding functions are obtained by a constructive procedure best explained by illustrative example. To find the interpolation function associated with node P , lines are drawn passing through all nodes except P , as shown by the dotted lines of Fig. 4(c). Each such line is described by writing an expression of the form

$$f_k(x,y) = A_kx + B_ky + C_k = 0. \quad (21)$$

The product of all such expressions has zero value at all nodes except P . To obtain an interpolation polynomial, it therefore remains to normalize the value of the product, so as to obtain unity value at P :

$$\psi_k(x,y) = \prod_k \frac{f_k(x,y)}{f_k(x_P,y_P)}. \quad (22)$$

This procedure is most efficiently carried out in homogeneous coordinates attached to the triangle or tetrahedron. The resulting algebraic construction esthetically appealing, for it exhibits function symmetries most effectively. Perhaps more importantly for computation, simplex elements allow producing “universal” matrices that only need to be multiplied by a few geometric properties that identify position, shape and size of the element. The analytic functions of element formulation need never be carried out by field analysis programs.

3.2. Flexible elements

Although triangular and tetrahedral elements permit ready modeling of quite complicated geometric shapes, they are necessarily restricted to rectilinear interfaces and do not represent curved surfaces very well. The conventional solution to this problem is

Finite elements: The first 50 years

Silvester

due to Ergatoudis, Irons and Zienkiewicz [22]. It is based on the simple observation that any Cartesian space coordinate, or indeed any linear measure of distance u , is (trivially) a linear function of the Cartesian coordinates x, y, z . It may therefore be expressed in terms of the finite element interpolation functions,

$$u(P) = \sum_i u(P_i) \psi_i(x_P, y_P, z_P), \quad (23)$$

where x_P, y_P, z_P are the coordinates of the point P . If the functions ψ_i are not merely linear, but quadratic or more complex, then (23) can express not merely a trivial linear dependence, but much more complicated coordinate transformations. Curvilinear elements are thus readily derived from rectilinear ones, by transforming the element functions. For example, the triangular element of Fig. 5(a) is mapped into the curved triangle of Fig. 5(b) by a transformation in this form. Such elements are known as *isoparametric*; their name implies that the *same* parametrization, and the same approximating functions, are used to model the geometric shape and the fields to be determined. Element matrices are now obtained by the same process as previously; however, the integrations and differentiations must be carried out with respect to the new coordinate system, not the parent one. While this is not difficult, it involves great quantities of lengthy algebraic expressions. Their evaluation is computationally more demanding than the equivalent numerical integration, so virtually all isoparametric element programs perform the integrations numerically.

Numerical integration is not a significant imposition in problems where nonlinear materials occur, for there the material properties are not analytically known and numerical integration is necessary anyway. In general, numerical integration techniques are very well developed in a single variable, less so in two or three independent variables. Numerous analysts therefore prefer quadrilateral or hexahedral isoparametric elements, such as shown in Fig. 5(c), to triangles or tetrahedra. Such elements were introduced to magnetic field problems at an early date [23], and have remained in use by several working groups.

The main drawback of the isoparametric element technique is that it possesses excess generality: it is even possible to express singular transformations in the form (23). Such transformations do not lead to useful elements. Unfortunately, no simple method is known for determining *a priori* whether a particular set of mapping coefficients $\{u_i, v_i, w_i\}$ represents an invertible transformation.

If the results obtained in a finite element analysis have insufficient accuracy, two approaches suggest themselves. One is to refine the element mesh, using a larger number of small elements in critical areas. Alternatively, the analysis may be repeated using elements of higher order, i.e., with a larger number of approximating functions per element. In the latter case, the use of *hierarchical* elements is often convenient. These are elements whose approximating functions ψ_i are constructed in nested families, so that the functions complete to first order are a proper subset of the functions of order 2, these in turn a proper subset of the functions of order 3, and so on. Such interpolation functions were first pioneered by Rossow and Katz [24] and have developed considerably since [25]. Because the approximating functions form nested families, programs can be organized to compute only the projection of the weak solution onto the newly added functions, not to repeat the entire calculation, when moving to a higher-order approximation.

3.3. Vector operators and elements

A difficulty encountered with weak-form equivalents to boundary-value problems, and apparently peculiar to electromagnetic field problems, is the existence of *spurious modes*. These are solutions to the wave or potential equations in weak form which do not have a strong-form counterpart, i.e. computational solutions that do not correspond to any

physical fields. They arise because the vector Helmholtz equation in strong form can be satisfied only by fields associated with a solenoidal magnetic field intensity \mathbf{H} , but the weak form is not so restricted. Consequently, weak solutions of the Helmholtz equation need not satisfy Maxwell's equations even though the corresponding strong solutions do. Koshiba, Hayata and Suzuki [26] reviewed the literature and methodology of this problem in the context of waveguides, where this problem was first observed in the 1960s. It has been pointed out more recently that deterministic problems can suffer from the non-physical modes equally well [27]. This should not be surprising, given that the matrix representations of the eigenvalue problem of guided waves, and the deterministic problem of forced fields, involve the same finite element matrices and therefore have the same eigenfunction spectra.

The spurious mode problem can be cured by the use of orthospectral ('correct-spectrum') element types as well as by some variant weak formulations. These have been treated in detail in a companion paper by Davies [28] and will not be further pursued here.

3.4. Geometrically infinite elements

One characteristic that sets electromagnetic fields apart from many other continuum problems is their frequently infinite geometric extent. Even static field problems often lack clearly defined finite boundaries, while an infinite region is the very basis of radiation and propagation problems. Several methods have accordingly been developed for handling what might be called "infinite finite elements", i.e., elements that encompass finite energy or power but have infinite geometric extent. A review of these, along with related methods from civil engineering practice, was given by Emson [29].

Consider the ribbon transmission line of Fig. 6(a). To analyze the fields surrounding it, and hence to determine its propagation characteristics, all the infinite-element methods encase the line in an artificial delimiting surface chosen more or less arbitrarily. This surface is thought to define a subdivision of all space into a finite interior and an infinite exterior region. The interior is readily modeled using conventional finite element techniques. The exterior is viewed as a special finite element, with a well-defined matrix description despite its geometrically infinite size. Thus the problem is reduced to that of constructing a finite element to represent the exterior region, as in Fig. 6(b). Numerous techniques are available for doing so, and at least four are properly convergent: (1) hybrid representations, (2) recursive growth, (3) inversion mapping, (4) special boundary conditions. All may be viewed as ways to find *boundary elements* which will correctly represent the field behavior in the interior, without explicitly calculating the field values at points in the infinite element.

The first, and possibly the most popular, technique proceeds by separating the field descriptions: differential equations in the interior portion, integral equations in the exterior. In essence, this means implicitly choosing the set of approximating functions $\{\beta_i | i=1, \dots, M\}$ to have precisely polynomial behavior along the exterior-interior interface (so as to match the interior element functions α_j) and to satisfy the relevant differential equation exactly in the exterior. This procedure was introduced and implemented around 1970 [30] and has been extended variously since. It is also possible to choose the exterior functions so as to satisfy the differential equation exactly, but to match the interior elements only at the element nodes, or in some equivalent approximate sense [31]; in this case, the exterior functions are perhaps most easily expressed as orthogonal series expansions or (in two dimensions) circular harmonics. In any case, the major difficulty in element formation remains, as in other integral representations, the need to evaluate singular integrals, the singularity being due to Green's function kernels. These may be dealt with by geometric transformations [32] or by generating special weighted quadrature functions [33]; or alternatively, by an

ingenious scheme of using double boundaries [34].

The family of recursive growth algorithms works by "growing" an extremely large, though still finite, exterior region from a finite-thickness shell or annulus [35]. Fig. 7(a) shows the inner region of a simple electrostatic problem. In Fig. 7(b) a crude model of the exterior region is provided, consisting of only an annular strip around the inner region; the strip is so constructed that its exterior and interior surfaces are geometrically similar except for scaling the dimensions by a constant factor. This strip is divided into conventional finite elements. It is enlarged by constructing another strip, geometrically similar except for the scaling factor, as in Fig. 7(c), and combining the two. Next, the finite element nodes in the interior of the shell region are eliminated, by enforcing the relevant differential equation to hold in the weak sense (a process known in structural mechanics as *static condensation*). The result is a shell region possessing interpolation nodes only on its surface, as in Fig. 7(d). This process can be repeated an arbitrary number of times, with the shell region growing ever larger. The growth rate can be exponential or even doubly exponential, depending on which variant of the algorithm is used; either way, only a few recursion steps generally suffice to achieve immensely large exterior regions. This method is applicable to propagating-wave problems, provided an approximate radiation condition is attached to the outer boundary and the growth of element size is controlled to ensure adequately good modeling of wavefronts wherever the wave amplitude has a significant value [36]. This family of methods has been used to solve waveguide problems [37,38] as well as two or three dimensional propagation.

Inversion mappings are ancient, and appeared as working tools for field analysis even in Maxwell's *Treatise*. The principle is simple enough. A boundary is again drawn around the interior region, as in Fig. 6, but this time the boundary shape is restricted to be circular or spherical, with radius R . The exterior is mapped into a finite region by inverting all radial distances r with respect to this radius:

$$r' = \frac{R^2}{r}. \quad (24)$$

The differential equation is transformed accordingly, and finite elements are constructed for this transformed differential equation. Two boundary-value problems thus result, one in the interior and one in the (transformed) exterior region; these are coupled by the requirement of field continuity at the separating boundary [39]. Laplace's equation occupies a very special role here, since it transforms into itself under an inversion mapping; but other equations present no particular difficulty. The circular (in three dimensions, spherical) inversion boundary proves surprisingly inconvenient in many cases so other boundary shapes have been proposed [40] by Imhoff *et al.*, and a fairly complete theory of alternative shapes has been given by Stochniol [41].

In propagating-wave problems, the method of *absorbing boundary conditions* has recently gained great popularity. This method was initially developed by Bayliss and his associates [42,43], and augmented by other workers [44]. A review of the available variants of this method was given by Cooray and Costache [45]. The principle is simple enough. At a boundary surface, the electromagnetic field is resolved into normally and tangentially propagating components, and the normally propagating part is in turn resolved into incoming and outgoing waves. A boundary element is created (a surface element in three-space or a line element in two-space) in which the wave function and its first derivatives are so related as to minimize the local reflection coefficient. Thus a normally-directed outgoing wave gives rise to little reflection; it is essentially *absorbed* by the boundary, much as a layer of dissipative absorbing material does in an anechoic room. Absorbing boundary elements of high quality are now available, the major remaining difficulty being one of boundary shapes. For waves to be resolvable into "incoming" and "outgoing" components at a surface, the wave equation must be

Finite elements: The first 50 years

Silvester

partially separable at the boundary. If ν denotes distance in the normal direction at a surface point, while τ, z are orthogonal tangential distance vectors, then the wave function Φ must be expressible in the form

$$\Phi(\nu, \tau, z, t) = \Phi_2(\nu, \tau) \left(e^{j\omega t - kz} + \Gamma(\nu, \tau) e^{j\omega t + kz} \right) \quad (25)$$

in order for the notion of *propagation direction* to make sense. Such a separation is readily possible in the classical orthogonal coordinate systems [46] but not at an arbitrarily shaped boundary. Consequently, absorbing boundary elements have for the present been developed only for flat, circular, spherical, and elliptic shapes. Numerical experiments have indicated [47] that piecewise-flat or piecewise-circular boundary approximations perform well, so long as the normal direction of the approximate boundary is close to the normal direction of the true boundary. This point is well illustrated by Fig. 8, which shows the *phase error* of a computed outgoing cylindrical wave at a cylindrical surface approximated by four parabolic segments. Since the outgoing wave should be totally absorbed, the phase error gives directly the wavefronts of the reflected wave entirely due to modeling error. It is clear from Fig. 8 that reflections occur at cusps in the boundary shape, where the misalignment of true and approximate normals is large, while virtually complete absorption is obtained where the normals coincide.

3.5. Symbolic generation of finite elements

Computing finite element matrices involves differentiation, expansion, and integration of polynomials, an almost embarrassingly obvious application of computer algebra. Algebra systems have therefore been used since their earliest days [48] when the Formac language became commonly available. Curiously, electrical engineers appear to have taken little initiative in this area and, with few exceptions, have been content to follow the lead of structural analysts. By the late 1980s MACSYMA was routinely used for element generation in applied mechanics but little hint of its use appears in the electrical engineering literature. Developments in this area were reviewed by Noor and Andersen [49], who took particular note of the large savings to be realized in exploiting group properties. These have been further exploited by Wang [50].

Outside the traditional mainstream of finite element analysis, computer algebra has found surprisingly little use, though there are notable exceptions. Thus, Bardell [51] has published a set of numerical tables for setting up two-dimensional hierarchical elements, along with the full symbolic program (written in REDUCE) used to generate them. Almost no use has been made of computer algebra systems in boundary elements, yet in this area their ability to perform symbolic integration should be exceedingly valuable. Similarly, the complicated functions necessary to deal with local field singularities lend themselves to treatment by computer algebra, and have been so treated by structural analysts [52].

It is probably fair to conclude that the symbolic algebra is a powerful tool for the finite element analyst, one likely to have major impact on electrical engineering applications in years to come. Its uses in the past decade have been extensive in structural analysis, but not in electromagnetics.

4. Application areas

Finite elements have variously been applied to problems of applied magnetics, to waveguides and resonators, to antennas and scatterers; there is also a substantial literature in the area of semiconductor process modeling. This very brief review concentrates mainly on early applications of finite elements, and therefore stresses the

areas of magnetics and microwave devices.

4.1. Magnetics

The early papers of Chari and Silvester [9,53] that dealt with finite element applications to magnetic field analysis were followed up by other workers fairly quickly. By 1980, major conferences included sessions entirely devoted to finite element methods, and by 1990 this had become the dominant numerical method for magnetics problems. The central problem here is to solve the magnetic vector potential equation

$$\nabla \times \left(\frac{1}{\mu_r} \nabla \times \mathbf{A} \right) - \mu_0 g \frac{\partial \mathbf{A}}{\partial t} = -\mu_0 g \mathbf{J}, \quad (26)$$

subject to appropriate boundary conditions. This field of finite element applications has been very active, and now accounts for nearly 50% of the finite element literature in electromagnetics. Konrad [54] has reviewed this field well, though in view of recent rapid growth, that review has now become dated.

The central problems of magnetic field analysis are twofold: electromagnetic field formulation and material property representation. Although the magnetic flux density \mathbf{B} due to a given set of currents is clearly unique, the accompanying vector potential \mathbf{A} is open to choice of gauge and therefore not unique. Gauge transformations are introduced by specifying the divergence of \mathbf{A} . Because the curl of \mathbf{A} must always equal the flux density \mathbf{B} , these two specifications define \mathbf{A} unequivocally. A typical choice is

$$\nabla \cdot \mathbf{A} = -\mu g V - \mu \epsilon \frac{\partial V}{\partial t}, \quad (27)$$

where V is the electric scalar potential. Numerous other choices are possible. However, they all have the same form in classical two-dimensional magnetostatics, where \mathbf{A} is time-invariant and possesses only one component. This situation characterizes a large class of useful problems in electromechanics and the electric machines community in particular adopted the finite element method at an early date. It was widely assumed that three-dimensional problems would be solvable by straightforward extensions of the techniques that worked so well in two dimensions, and that it was merely a matter of waiting for computing machines to grow large and powerful enough to handle three-dimensional problems. This supposition, however, proved false. Initial attempts to solve three-dimensional problems largely ignored the question of gauge [55]; in other words, they allowed the computer to choose the gauge through arithmetic chance and roundoff error. The resulting values of \mathbf{A} , of course, are irreproducible, though \mathbf{B} is well defined. Difficulties were reported with convergence of nonlinear solutions, perhaps not surprisingly since the computer program remained free to select a new choice of gauge on each iteration! The gauge problem and the associated choice of potential formulation may now be regarded as solved problems [56,57] — so far as any problem in technology is ever solved — but it has taken almost a decade to establish what methods are actually useful and correct.

This area has produced considerable quantities of software packages for general use by design engineers and analysts, experts in magnetics with little knowledge of finite element methods. Lari and Turner [58] compiled a review of the available techniques and programs in 1984, and many of their remarks regarding methodology remain valid; but a much more comprehensive survey of both the methods and the available software packages is given in the more recent paper by Tseng [59].

4.2. Microwave Devices

Microwave devices were the first class of electromagnetic field problem solved by finite element methods, and a significant number of papers have now been published on applications to guided-wave problems. Daly [60] used the method at an early date for analyzing wave propagation in microstrip lines, and the hollow waveguide problem attracted sufficient analysis to merit a review paper [61] shortly thereafter. Stone [62] extended the methodology to acoustic guided waves and Konrad analyzed cavity resonators [63]. More recently, finite elements have had particularly strong impact in the analysis of optical waveguides [64] and related devices.

In the area of antennas and scatterers, point-matching methods had established a firm hold by the late seventies. Finite element methods therefore took some time to become established. Nevertheless, a considerable amount of work has now been accomplished. The review by Glisson [65] indicates much valuable material, though unfortunately it is now several years out of date.

Optical and microwave applications of finite elements, particularly current and recently developed techniques, are reviewed in a companion paper [28].

5. Conclusions

Finite elements in electrical engineering have had a varied and interesting history. At an early stage of development, several difficult problems were encountered, such as the determination of gauge in vector potential problems and the appearance of spurious modes in solutions of the Helmholtz equation. It has taken nearly twenty years to master these difficulties, and their solutions point the way for other, still more valuable, methods.

Unsolved problems of considerable importance now include general methods for (1) orthospectral elements, (2) field singularities, (3) boundary integrals, including absorbing boundaries. Several particular element types free of spurious modes are known and used, but the generation of families of such elements has still eluded analysts. Much the same can be said for singular elements. In the formation of boundary integrals, similar difficulties of integration are encountered as with field singularities. All three areas should prove fertile ground for the application of symbolic algebra. Given the current near-ubiquity of computer algebra systems, there appears to be every reason for optimism in the further development of finite element methods in electromagnetics.

6. References

- [1] R.L. Courant: 'Variational methods for the solution of problems of equilibrium and vibration.' *Bulletin of the American Mathematical Society*, vol. 49, pp. 1-23, 1943.
- [2] Rayleigh: 'On the approximate solution of certain problems relating to the potential.' *Proceedings of the London Mathematical Society*, vol. 7, pp. 70-75, 1876. (Reprinted: *Sci. Pap.*, vol. 1, no. 39.)
- [3] R.J. Duffin: 'Distributed and lumped networks.' *Journal of Mathematics and Mechanics*, vol. 8, pp. 793-826, 1959.
- [4] R.J. Duffin and T.A. Porsching: 'Bounds for the conductance of a leaky plate via network models.' *Proceedings, Symposium on Generalized Networks*. Brooklyn: Polytechnic Press, 1959. Pp. 417-442.
- [5] J.L. Synge: *The Hypersphere in Mathematical Physics*. Cambridge: Cambridge University Press, 1957.
- [6] R.V. Southwell: *Relaxation methods in engineering science; a treatise on*

- approximate computation*. Oxford: Clarendon Press, 1940. *Relaxation methods in theoretical physics*. Oxford: Clarendon Press, 1946.
- [7] A.M. Winslow: 'Numerical solution of the quasilinear Poisson equation on a nonuniform triangle mesh.' *Journal of Computational Physics*, vol. 2, pp. 149-172, 1967.
 - [8] P. Silvester: 'Finite-element solution of homogeneous waveguide problems.' *Alta Frequenza*, vol. 38, pp. 313-317, 1969.
 - [9] P. Silvester and M.V.K. Chari: 'Finite element solution of saturable magnetic field problems.' *IEEE Transactions on Power Apparatus and Systems*, vol. PAS-89, pp. 1642-1651, 1970.
 - [10] Z.J. Csendes and P. Silvester: 'Numerical solution of dielectric loaded waveguides. I — Finite-element analysis.' *IEEE Transactions on Microwave Theory and Techniques*, vol. MTT-19, pp. 504-509, 1971.
 - [11] P. Benedek and P. Silvester: 'Capacitance of parallel rectangular plates separated by a dielectric sheet.' *IEEE Transactions on Microwave Theory and Techniques* vol. MTT-20, pp. 504-510, 1972.
 - [12] P. Silvester and K.K. Chan: 'Bubnov-Galerkin solutions to wire-antenna problems.' *Proceedings IEE*, vol. 119, pp. 1095-1099, 1972.
 - [13] M. Zlámal: 'On the finite element method.' *Numerische Mathematik*, vol. 12, pp. 394-409, 1968.
 - [14] J.R. Whiteman [ed.]: *The mathematics of finite elements and applications*. London: Academic Press, 1973.
 - [15] P.C. Ciarlet: *The finite element method for elliptic problems*. Amsterdam: North Holland, 1978.
 - [16] M.A. Krasnosel'skii, G.M. Vainikko, P.P. Zabreiko, Ya.B. Rutitskii and V.Ya. Stetsenko: *Approximate solution of operator equations*. Groningen: Noordhoff, 1972.
 - [17] S.G. Mikhailin and K.L. Smolitskiy: *Approximate methods for solution of differential and integral equations*. New York: Elsevier, 1967.
 - [18] P. Silvester: 'TEM properties of microstrip transmission lines.' *IEE Proceedings*, vol. 115, pp. 43-49, 1968.
 - [19] J.T. Oden and J.N. Reddy: *An introduction to the mathematical theory of finite elements*. New York; Wiley, 1976.
 - [20] R.F. Harrington: *Field computation by moment methods*. New York: Macmillan, 1968.
 - [21] P. Silvester: 'High-order polynomial triangular finite elements for potential problems.' *International Journal of Engineering Science*, vol. 7, pp. 849-861, 1969.
 - [22] I. Ergatoudis, B.M. Irons and O.C. Zienkiewicz: 'Curved isoparametric 'quadrilateral' elements for finite element analysis.' *International Journal of Solids and Structures*, vol. 4, pp. 31-42, 1968.
 - [23] P. Silvester and P. Rafinejad: 'Curvilinear finite elements for two-dimensional saturable magnetic fields.' *IEEE Transactions on Power Apparatus and Systems*, vol. PAS-93, pp. 1861-1870, 1974.
 - [24] M.P. Rossow and I.N. Katz: 'Hierarchal finite elements and precomputed arrays.' *International Journal for Numerical Methods in Engineering*, vol. 12, pp. 977-999, 1978.
 - [25] J.P. Webb and S. McFee: 'The use of hierarchal triangles in finite-element analysis of microwave and optical devices.' *IEEE Transactions on Magnetics*, vol. 27, pp. 4040-4043, 1991.
 - [26] M. Koshiba, K. Hayata and M. Suzuki: 'Finite-element method analysis of microwave and optical waveguides — trends in countermeasures to spurious solutions.' *Electronics and Communications in Japan*, 2, *Electronics*, vol. 70, no 9, pp. 96-108, 1986. [Translation of article in *Trans. Inst. Electron. & Commun. Eng. Japan*, Part C, vol. J69C, pp. 1477-1486, 1986.]
 - [27] A.R. Pinchuk, C.W. Crowley and P.P. Silvester: 'Spurious solutions to vector

Finite elements: The first 50 years

Silvester

- diffusion and wave field problems.' *IEEE Transactions on Magnetics*, vol. MAG-24, pp. 158-161, 1988.
- [28] J.B. Davies, 'Review of finite element methods for microwave and optical structures.' *Alta Frequenza*, this issue.
- [29] C.R.I. Emson: 'Methods for the solution of open-boundary electromagnetic-field problems.' *IEE Proceedings*, part A, vol. 135, pp. 151-158, 1988.
- [30] P. Silvester and M.-S. Hsieh: 'Finite-element solution of 2-dimensional exterior-field problems.' *Proceedings IEE*, vol. 118, pp. 1743-1747, 1971.
- [31] K.K. Mei: 'Unimoment method of solving antenna and scattering problems.' *IEEE Transactions on Antennas and Propagation*, vol. AP-22, pp. 760-766, 1974.
- [32] P. Silvester and M.-S. Hsieh: 'Projective solution of integral equations arising in electric and magnetic field problems.' *Journal of Computational Physics*, vol. 8, pp. 73-82, 1971.
- [33] P.P. Silvester: 'Weighted Gaussian quadratures for singular and near-singular integrands.' *International Journal of Numerical Modelling*, vol. 2, pp. 131-142, 1989.
- [34] B.H. McDonald and A. Wexler: 'Finite element solution of unbounded field problems.' *IEEE Transactions on Microwave Theory and Techniques*, vol. MTT-20, pp. 841-847, 1972.
- [35] P.P. Silvester, D.A. Lowther, C.J. Carpenter and E.A. Wyatt: 'Exterior finite elements for two-dimensional field problems with open boundaries.' *Proceedings IEE*, vol. 124, pp. 1267-1270, 1977.
- [36] C.I. Goldstein: 'The finite element method with non-uniform mesh sizes applied to the exterior Helmholtz problem.' *Numerische Mathematik*, vol. 38, pp. 61-82, 1981.
- [37] C.I. Goldstein: 'Finite element methods applied to nearly one-way wave propagation.' *Journal of Computational Physics*, vol. 64, pp. 56-81, 1986.
- [38] S.L. Foo and P.P. Silvester: 'Boundary-marching method for discontinuity analysis in waveguides of arbitrary cross section.' *IEEE Transactions on Microwave Theory and Techniques*, vol. MTT-40, (in press), 1992.
- [39] I.R. Ciric and S.H. Wong: 'Inversion transformation for the finite-element solution of three-dimensional exterior-field problems.' *COMPEL*, vol. 5, pp. 109-119, 1986.
- [40] J.F. Imhoff, G. Meunier, X. Brunotte and J.C. Sabonnadiere: 'An original solution for unbounded electromagnetic 2-D and 3-D problems throughout the finite element method.' *IEEE Transactions on Magnetics*, vol. 25, pp. 4135-4137, 1989.
- [41] A. Stochniol: 'An efficient open boundary finite element method for electromagnetic problems.' *COMPEL*, vol. 11, pp. 53-56, 1991.
- [42] A. Bayliss and E. Turkel: 'Boundary conditions for exterior acoustic problems.' *Advances in Computer Methods for Partial Differential Equations III*. [R. Vichnevetsky and R.S. Steplman, eds.] Pp. 127-131. New Brunswick, NJ: IMACS, 1979.
- [43] A. Bayliss, M. Gunzburger and E. Turkel: 'Boundary conditions for the numerical solution of elliptic equations in exterior regions.' *SIAM Journal on Applied Mathematics*, vol. 42, pp. 430-451, 1982.
- [44] J.E. Santos, J. Douglas, Jr., M. Morley and O.M. Lovera: 'Finite element methods for a model for full waveform acoustic logging.' *IMA Journal of Numerical Analysis*, vol. 8, pp. 415-433, 1983.
- [45] F.R. Cooray and G.I. Costache: 'An overview of the absorbing boundary conditions.' *Journal of Electromagnetic Waves and their Applications*, vol. 5, pp. 1041-1054, 1991.
- [46] P. Moon and D.E. Spencer: *Field Theory Handbook*. 2nd ed. Berlin: Springer, 1971.
- [47] S. McFee and P.P. Silvester: 'Geometric modeling guidelines for absorbing boundary conditions in finite element analysis.' *International Journal for Electromagnetic Fields in Materials*, vol. 4, (in press), 1992.
- [48] A. Konrad and P. Silvester: 'Triangular finite elements for the generalized Bessel equation of order m .' *International Journal for Numerical Methods in Engineering*,

- vol. 7, pp. 43–55, 1973.
- [49] A.K. Noor and C.M. Andersen: 'Computerized symbolic manipulation in nonlinear finite element analysis.' *Computers and Structures*, vol. 13, pp. 379–403, 1981.
- [50] P.S. Wang: 'Taking advantage of symmetry in the automatic generation of numerical programs for finite element analysis.' *Proceedings, EUROCAL '85*. [B.F. Caviness, ed.] Vol. 2, pp. 572–582. Berlin: Springer, 1985.
- [51] N.S. Bardell: 'The application of symbolic computing to the hierarchical finite element method.' *International Journal for Numerical Methods in Engineering*, vol. 28, pp. 1181–1204, 1989.
- [52] N.I. Ioakimidis: 'The location of discontinuity intervals of sectionally analytic functions: application to the interface crack problem.' *Computers and Mathematics, with Applications*, vol. 21, pp. 69–74, 1991.
- [53] M.V.K. Chari and P. Silvester: 'Finite-element analysis of magnetically saturated d-c machines'. *IEEE Transactions on Power Apparatus and Systems*, vol. PAS-90, pp. 2362–2372, 1971.
- [54] A. Konrad: 'Electromagnetic devices and the application of computational techniques in their design.' *IEEE Transactions on Magnetics*, vol. MAG-21, pp. 2382–2387, 1985.
- [55] M.V.K. Chari, A. Konrad, J. D'Angelo and M. Palmo: 'Finite element computation of three-dimensional electrostatic and magnetostatic field problems.' *IEEE Transactions on Magnetics*, vol. MAG-19, pp. 2321–2324, 1983.
- [56] O. Biró and K. Preis: 'Finite element analysis of 3-D eddy currents.' *IEEE Transactions on Magnetics*, vol. 26, pp. 418–423, 1990.
- [57] T. Morisue: 'The gauge and topology problem in using the magnetic vector potential.' *COMPEL*, vol. 9, Supplement A, pp. 1–6, 1990.
- [58] R.J. Lari and L.R. Turner: 'Survey of eddy current programs.' *IEEE Transactions on Magnetics*, vol. MAG-19, pp. 2474–2477, 1983.
- [59] A.A. Tseng: 'Electroheating modeling in metal processing: a review.' *Advances in Engineering Software*, vol. 10, pp. 58–71, 1988.
- [60] P. Daly: 'Hybrid-mode analysis of microstrip by finite element methods.' *IEEE Transactions on Microwave Theory and Techniques*, vol. MTT-19, pp. 19–25, 1971.
- [61] F.L. Ng: 'Tabulation of methods for the numerical solution of the hollow waveguide problem.' *IEEE Transactions on Microwave Theory and Techniques*, vol. MTT-22, pp. 322–329, 1974.
- [62] G.O. Stone: 'High-order finite elements for inhomogeneous acoustic guiding structures.' *IEEE Transactions on Microwave Theory and Techniques*, vol. MTT-21, pp. 538–542, 1973.
- [63] A. Konrad: 'A linear accelerator cavity code based on the finite element method.' *Computer Physics Communications*, vol. 13, pp. 349–362, 1978.
- [64] B.M.A. Rahman and J.B. Davies: 'Finite-element analysis of optical and microwave waveguide problems.' *IEEE Transactions on Microwave Theory and Techniques*, vol. MTT-32, pp. 20–28, 1984.
- [65] A.W. Glisson: 'Recent advances in frequency domain techniques for electromagnetic scattering problems.' *IEEE Transactions on Magnetics*, vol. 25, pp. 2867–2871, 1989.

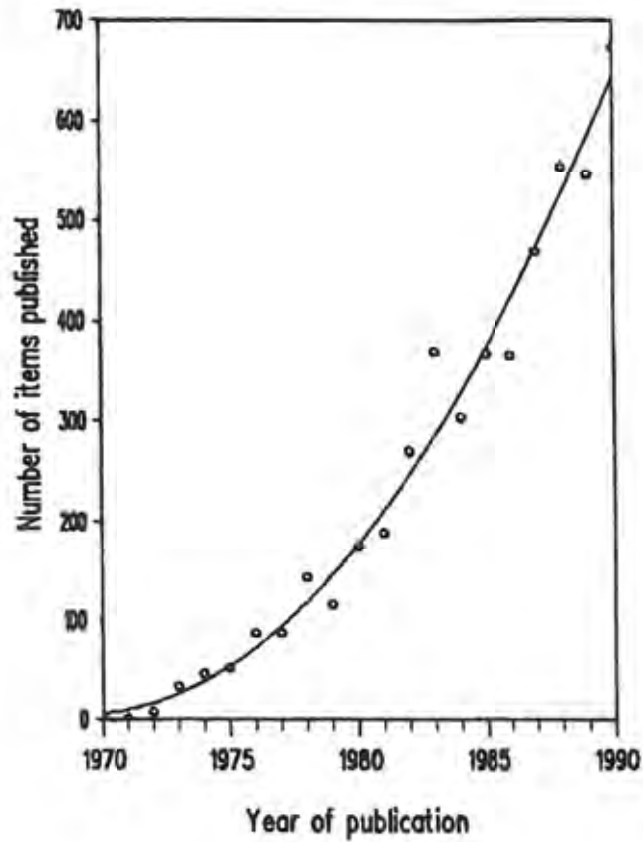

Fig. 1. Annual production of finite element publications in electrical engineering and electrophysics, 1970-1990.

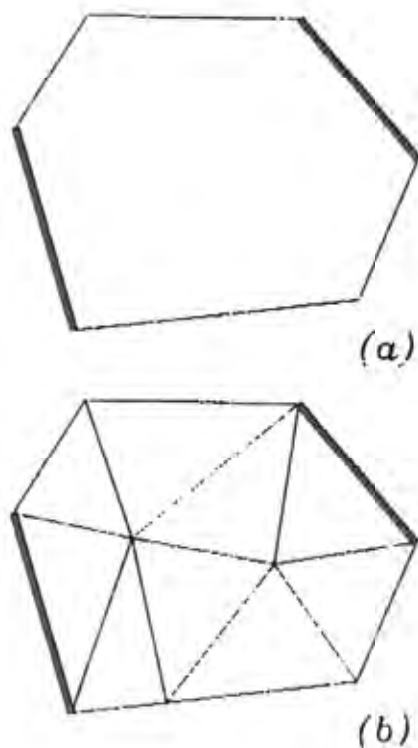

Fig. 2. (a) Simply connected region Ω ; Dirichlet boundaries ∂_D shown in heavy outline. Neumann boundaries ∂_N in light outline. (b) One possible subdivision of Ω into triangular finite elements.

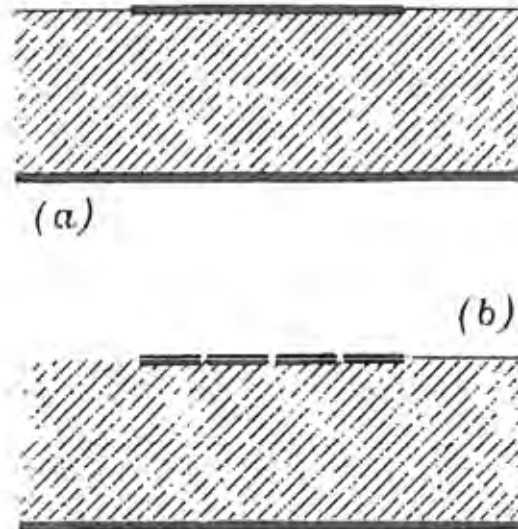

Fig. 3. (a) Microstrip line on dielectric substrate. (b) Subdivision of microstrip into four one-dimensional finite elements.

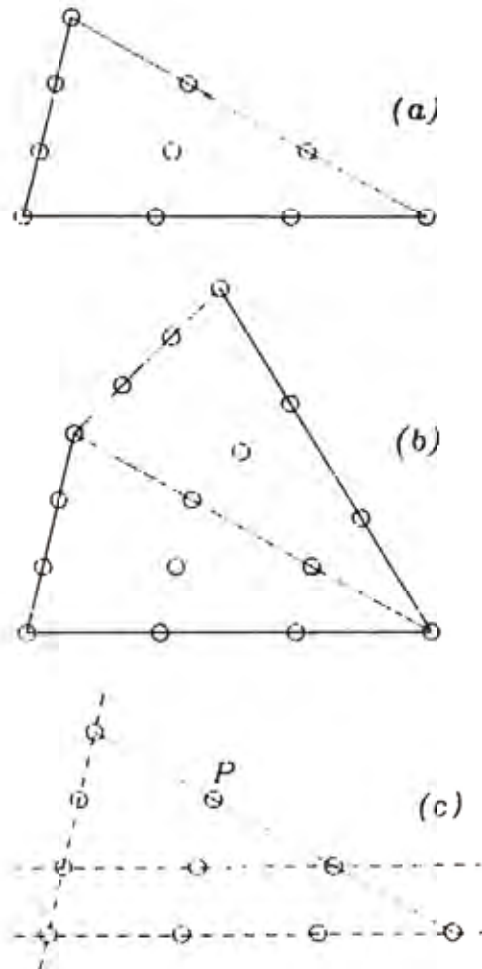

Fig. 4. (a) Triangular finite element with cubic interpolation node set. (b) Two cubic triangular elements. The shared nodes allow precisely cubic interpolation along the interelement boundary. (c) Construction of interpolation functions for cubic triangle.

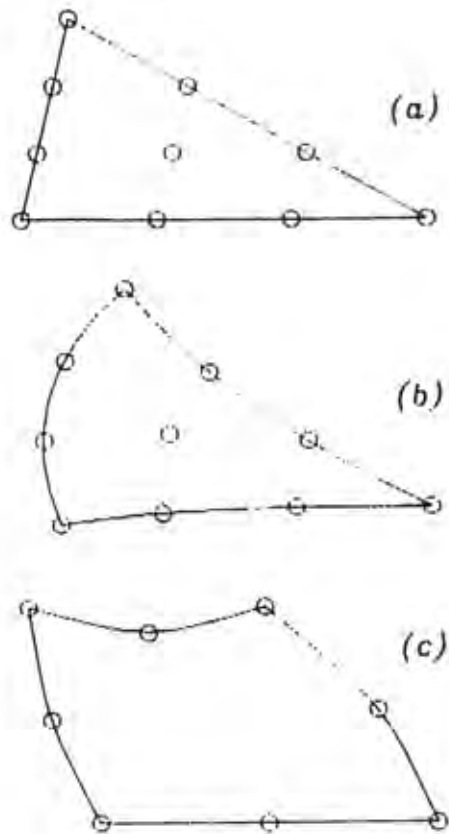

Fig. 5. Isoparametric element generation. (a) Parent element. (b) Isoparametric triangle derived by coordinate mapping. (c) Isoparametric quadrilateral, similarly derived from square element.

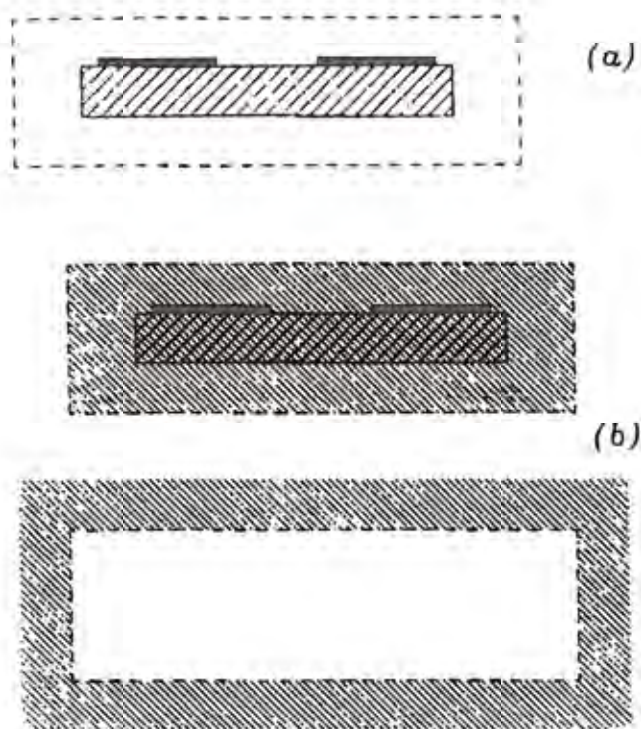

Fig. 6. (a) An artificial boundary encases the region of analysis interest. (b) Space exterior to the artificial boundary is represented as an infinitely-extending element.

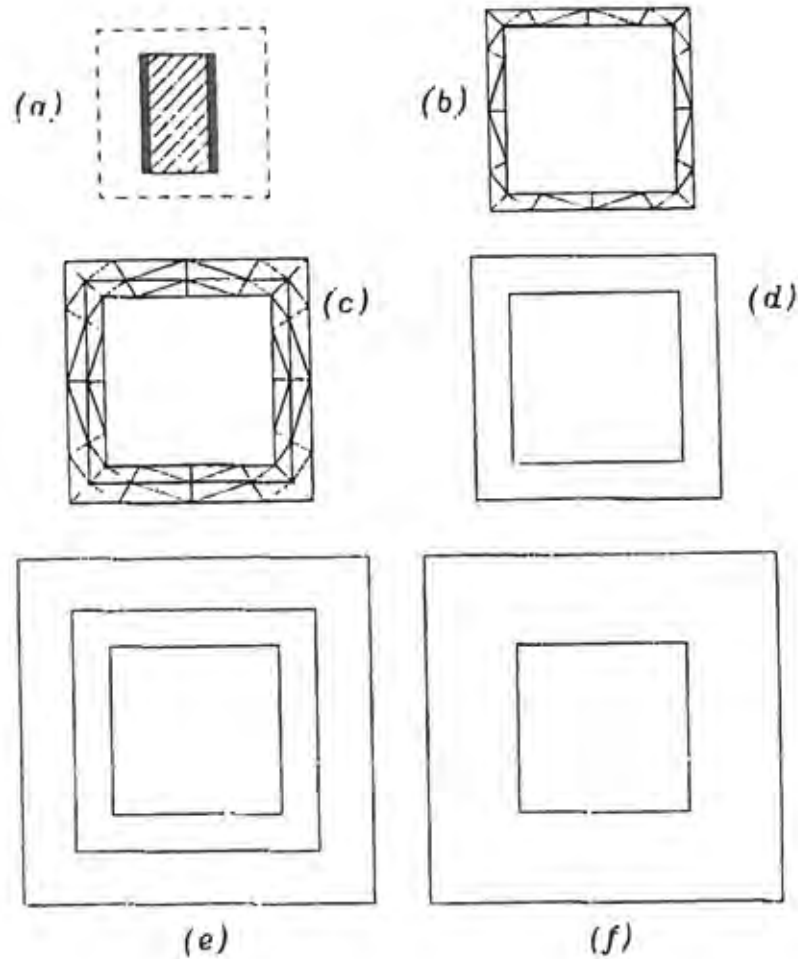

Fig. 7. Recursive generation of exterior element. (a) Interior region for analysis. (b) Single shell of finite elements to represent finite exterior region. (c) Two shells, the second obtained by geometric scaling. (d) Elimination of interior variables yields a "superelement" equivalent to the double shell. (e) Two shells, the second obtained by geometric scaling. (f) Elimination of interior variables to obtain still thicker shell.

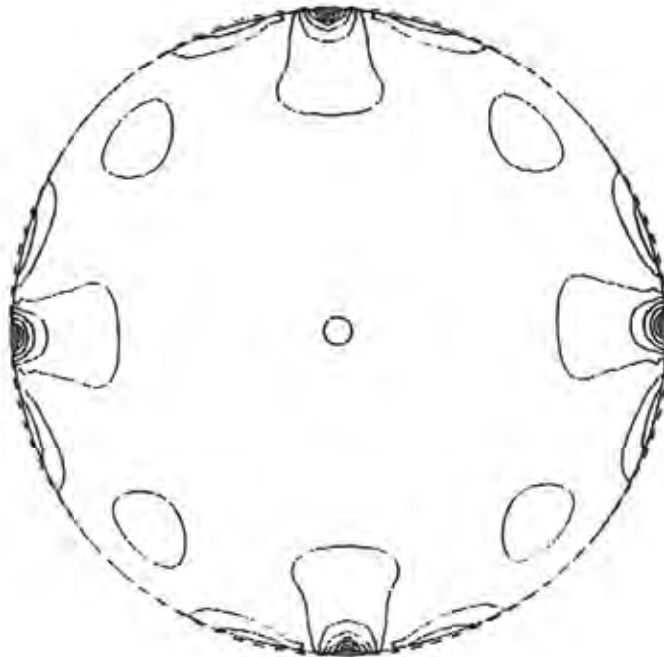

Fig. 8. Wavefront of reflected wave from Bayliss-Turkel absorbing boundary. The true circular region is shown in dotted outline, the finite element model by the solid line. Error is largest wherever the normal directions of the boundaries deviate substantially.

WORKSHOP POSTERS AND CALL FOR PAPERS, FROM 1992 TO PRESENT



DIPARTIMENTO DI INGEGNERIA ELETTRONICA
UNIVERSITA' DEGLI STUDI DI FIRENZE

GIORNATE DI STUDIO SU:

IL METODO DEGLI ELEMENTI FINITI (FEM) NELLE APPLICAZIONI DELL'ELETTROMAGNETISMO

26-27 Maggio 1992

presso il Centro Studi "I Cappuccini" della Cassa di Risparmio di San Miniato, Pisa

Organizzate con il patrocinio di:

- AEI, Gruppo Specialistico "Elettromagnetismo"
- ALENIA, Aeritalia & Selenia SpA
- ALENIA SPAZIO SpA
- BULL HN Information Systems Italia SpA
- CEIA SpA
- CNR, Gruppo Nazionale di coordinamento in Elettromagnetismo Applicato
- DIGITAL EQUIPMENT SpA
- IDS, Ingegneria dei Sistemi SpA
- IEEE, Central and South Italy Section, MTT/AP Joint Chapter
- OFFICINE PANERAI SpA
- SMA, Segnalamento Marittimo ed Aereo SpA



Negli ultimi anni si e' manifestato un crescente interesse per il metodo degli elementi finiti (FEM) nelle applicazioni dell'elettromagnetismo. Sebbene le prime applicazioni del FEM ai problemi elettromagnetici risalgano a circa 20 anni fa, la diffusione di tale metodo e' stata rallentata dalla limitata disponibilita' di adeguate risorse di calcolo e da uno scarso sviluppo dei codici per una rapida manipolazione della geometria del problema. Il recente sviluppo della tecnologia ha dato nuovo impulso ed ha consentito tra l'altro di immettere sul mercato pacchetti 'software' dedicati all'analisi dei problemi elettromagnetici che fanno uso del FEM, rendendoli disponibili anche all'utente medio.

E' sembrato utile ed opportuno organizzare le *Giornate di Studio* invitando sia due dei maggiori esperti mondiali ad una introduzione, anche sotto il profilo storico, delle applicazioni del FEM ai problemi dell'elettromagnetismo sia qualificati studiosi italiani ad illustrare le loro piu' recenti esperienze nel settore. L'interesse suscitato dall'iniziativa e' stato decisamente superiore alle aspettative, per cui si e' ritenuto utile inserire nel programma un'ulteriore sessione 'aperta' ai contributi di quei ricercatori che, per carenza di informazione, non erano noti ai promotori dell'incontro.

Per ulteriori informazioni:

Prof. M. Calamia, Prof. G. Pelosi
Dipartimento di Ingegneria Elettronica - Universita' degli Studi di Firenze - Via di Santa Marta 3, 50139 FIRENZE
Tel: +39-55-4796 269/372 - Fax: +39-55-404392
E-Mail: PELOSI@INGFII.CINECA.IT

Segreteria Organizzativa

STUDIO GRIN
Via Bolognese, 165 - 50139 FIRENZE
Tel: +39-55-400 737/604 - Fax: +39-55-400 604

A Joint OrganizationUniversity
of
Florence

McGill

2nd Workshop on

**FINITE ELEMENT METHODS IN
ELECTROMAGNETIC WAVE PROBLEMS**

May 24-26, 1994

University of Siena, Certosa di Pontignano, Siena, Italy



The Workshop is jointly organised by the University of Florence and by McGill University of Montreal. It will cover application of the Finite Element Methods to electromagnetic field problems with emphasis on problems related to electromagnetic radiation and scattering, guided waves, parameter determination for resonators and filters, active and passive microwave devices. Particular attention will be devoted to industrial applications.

Steering Committee

M. Calamia *University of Florence, Italy*
(Co-Chairman)
P. P. Silvester *McGill University, Montreal,*
Quebec, Canada (Co-Chairman)

G. Pelosi *University of Florence, Italy*
(Scientific Secretary)
P. Barbini *University of Siena, Italy*
J. B. Davies *University College, London,*
United Kingdom

P. Guillon *University of Limoges, France*
G. Molinari *University of Genoa, Italy*
J. L. Volakis *University of Michigan,*
Ann Arbor, Michigan, U.S.A.

Supported by:

- AEI - Associazione Elettrotecnica ed Elettronica Italiana
- Alenia S.p.A., Rome, Italy
- CEA - Commissariat à l'Energie Atomique, Le Barp, France
- CEIA S.p.A., Arezzo, Italy

- CNR - Consiglio Nazionale delle Ricerche
- IDS - Ingegneria dei Sistemi S.p.A., Pisa, Italy
- IEE - The Institution of Electrical Engineers
- IEEE - The Institute of Electrical and Electronic Engineers - Central & South Italy Section/MTT-AP Joint Chapter

- MPS, Monte Dei Paschi di Siena
- Officine Panerai S.p.A., Florence, Italy
- SMA S.p.A., Florence, Italy
- University of Florence, Florence, Italy
- University of Siena, Siena, Italy

Scientific Secretariat:

FEM - SIENA94
Electrical Engineering Department
University of Florence
Via C. Lombroso 6/17, I-53134 Florence - Italy
Tel.: +39-55-4796756, Fax: +39-55-4796767
E-mail: siena94@ingf1.ing.unifi.it

Organising Secretariat:

FEM - SIENA94
Congress Service
University of Siena
Via S. Vigilio 6, I-53100 Siena - Italy
Tel.: +39-577-298256, +39-577-298257
Fax: +39-577-298377

Hotel Reservations:

FEM-SIENA94
Cooperativa Siena Hotel Promotion
Piazza San Domenico 2, I-53100 Siena - Italy
Tel +39-577-289084
Fax +39-577-280290

3rd International Workshop on Finite Element Methods in Electromagnetic Wave Problems

Halifax, Nova Scotia, Canada
July 9-11, 1996

First Announcement

The Workshop will cover the application of Finite Element Methods to electromagnetic field problems with emphasis on problems related to electromagnetic radiation and scattering, guided waves, parameter determination for resonators and filters, active and passive microwave devices. Particular attention will be devoted to industrial applications.

To obtain information about the Workshop, send an e-mail message containing the words "send info" to FEW96@newton.ccs.tuns.ca or write to Dr. Z.D. Chen, Electrical Engineering Department, Technical University of Nova Scotia, PO Box 1000, Halifax, NS, Canada B3J 2X4 (Fax: +1-902-422-7535).

For details about submitting a paper, send an e-mail message to FEW96@ingfi1.ing.unifi.it or write to Dr. G. Pelosi, Electrical Engineering Department, Microwave Laboratory, Via C. Lombroso 6/17, I-50134 Florence, Italy (Fax: +39-55-4796-767).



✂-----
Please complete this form and return it to one of the above addresses.

Name: _____

Institution: _____

Address: _____

Phone: _____

Fax: _____

E-mail: _____

I wish to offer a contribution provisionally entitled: _____

I intend to attend the workshop.

Please send me further information when available.



Universités de Limoges et de Poitiers



4th International Workshop
on
**FINITE ELEMENTS FOR
MICROWAVE ENGINEERING**
From Electromagnetic to Microwave Electronics Software

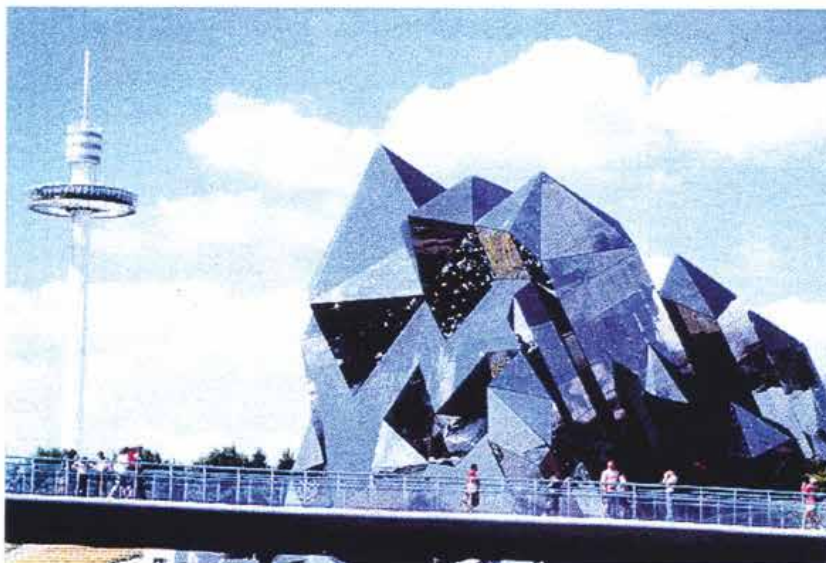

Futuroscope - Poitiers, France

July 10-11, 1998



5th International Workshop on Finite Elements for Microwave Engineering

John Hancock Conference Center

40 Trinity Place

Boston, Massachusetts 02116, USA

June 8-9, 2000



Chairs:

Z. J. Cendes, Ansoft Corp.

G. Pelosi, U. of Florence

Secretary:

J. F. Lee, WPI

R. Lee, Ohio-State University

Scientific Committee:

J. P. Berenger, CAD-ETCA

A. Cangellaris, U. of Illinois

R. Coccioli, UCLA

T. A. Cwik, JPL

D. B. Davidson, U. of Stellenbosch

R. Dyczij-Edlinger, Ansoft Corp.

R. L. Ferrari, Trinity College

P. Guillon, U. of Limoges

J. Jin, U. of Illinois

A. Konrad, U. of Toronto

M. Koshiba, Hokkaido University

E. Lucas, Northrop Grumman Corp.

R. Mittra, Penn State University

A. Papiernik, U. of Nice-Sophia Autipolis

M. Salazar-Palma, Polytechnic of Madrid

S. Selleri, U. of Florence

D. K. Sun, Ansoft Corp.

J. L. Volakis, U. of Michigan

6th International Workshop on FINITE ELEMENTS FOR MICROWAVE ENGINEERING

Antennas, Circuits and Devices



with participation from

University of Michigan at Ann Arbor, USA
Arizona State University at Tempe, USA
Michigan State Univ. at Lansing, USA
Nat. Technical Univ. of Athens, Greece
University of Florence, Italy
Institute of Communication
and Computer Systems, Greece

Steering Committee:

C.A. Balanis, Tech. Co-Chair
Arizona State Univ., USA
A. Cangellaris
Univ. of Illinois, USA
Z.J. Cendes
Ansoft Co., USA
P. Gullon
Univ. of Limoges, FRANCE
D.I. Kaklamani, Local Chair
Nat. Techn. Univ. of Athens
GREECE
L. Kempel, Tech. Co-Chair
Michigan State Univ., USA
M. Koshiba
Hokkaido Univ., JAPAN
J.F. Lee
Ohio State Univ., USA
R. Lee
Ohio State Univ., USA
G. Pelosi
Gen. Co-chair
University of Florence
ITALY
M. Salazar-Palma
Polytechnic of Madrid
SPAIN
J.L. Volakis
Gen. Co-Chair
Univ. of Michigan
USA
J.P. Webb
McGill University
CANADA

Homerion
Center
CHIOS Greece

may 30 to june 12 2002

topics

Antennas

Computational Electromagnetics

Scattering

Passive and Active Microwave Devices

Microwave Electronics

Other Related Topics

one page electronic abstracts due February 1, 2002
acceptance notification will be sent by March 1, 2002

<http://speed.esd.ece.ntua.gr/>



**7th International Workshop on
Finite Elements for Microwave Engineering**
ANTENNAS, CIRCUITS AND DEVICES



HOTEL NH PARQUE DE LAS AVENIDAS
May 20 -21, 2004, Madrid, Spain



Organized by

Polytechnic University of Madrid (Spain)
University of Florence (Italy)

Sponsored by



8th International Workshop on Finite Elements for Microwave Engineering

25-26 May 2006, Spier Wine Estate, Stellenbosch, South Africa



CALL FOR PAPERS

Submission Deadline: 27 January 2006

The International Workshop on Finite Elements for Microwave Engineering is a highly-focussed biennial event. The Workshop provides an ideal meeting place for researchers and practitioners active in the theory and application of the finite element method (FEM) in RF and microwave engineering.

This is the first time that the Workshop will be held in the southern hemisphere. The Spier Wine Estate is located in the countryside just outside the town of Stellenbosch, and some 40km away from the cosmopolitan city of Cape Town, one of South Africa's capitals.

Technical areas covered by the Workshop include, but are not limited to —

- Adaptive Methods
- Advanced Formulations, Solvers, Discretizations
- FEM Applications: Antennas, Microwave Circuits, Etc.
- Hybrid Methods
- Multigrid- and Domain Decomposition Methods
- Optimization and Parameter Sweep Techniques
- Time Domain FEM: Theory and Applications

General Chair: D.B. Davidson, *University of Stellenbosch, South Africa*

General Co-Chairs: F.J.C. Meyer, *EMSS, Stellenbosch, South Africa*, G. Pelosi, *University of Florence, Italy*

Technical Program Committee: M. Bingle, *EMSS, Stellenbosch, South Africa*, M.M. Botha (Chair), *University of Stellenbosch, South Africa*

Steering Committee: A. Cangellaris, *University of Illinois, Champaign, IL, USA*, Z.J. Cendes, *Ansoft Co., Pittsburgh, PA, USA*, D.B. Davidson, *University of Stellenbosch, South Africa*, R.L. Ferrari, *Trinity College, University of Cambridge, UK*, J. Jin, *University of Illinois, Champaign, IL, USA*, J.F. Lee, *Ohio State University, Columbus, OH, USA*, R. Lee, *Ohio State University, Columbus, OH, USA*, L. Kempel, *Michigan State University, East Lansing, MI, USA*, G. Pelosi, *University of Florence, Italy*, M. Salazar-Palma, *Polytechnic University of Madrid, Spain*, J.L. Volakis, *Ohio State University, Columbus, OH, USA*, J.P. Webb, *McGill University, Montreal, QC, Canada*, J. Zapata, *Polytechnic University of Madrid, Spain*

Sponsors:



<http://courses.ee.sun.ac.za/FEM2006/>

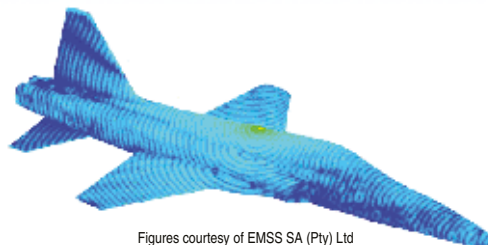
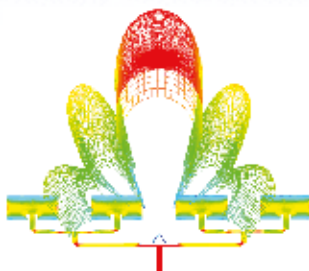

Figures courtesy of EMSS SA (Pty) Ltd

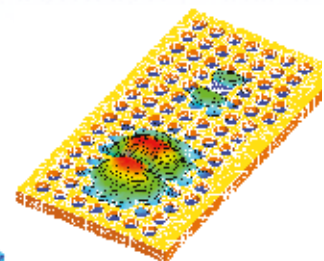



9th International Workshop on Finite Elements for Microwave Engineering

8-9 May 2008, Bonn, Germany

<http://www.lte.uni-saarland.de/fem2008>

Abstract Submission Deadline: 25 January 2008

General: The International Workshop on Finite Elements for Microwave Engineering is a highly focussed biennial event. It provides an ideal meeting place for researchers and practitioners active in theory and application of the finite element method (FEM) in radio frequency and microwave engineering. There will be oral sessions only.

Venue: The Workshop takes place in the city of Bonn, the birthplace of Ludwig van Beethoven and former capital of West Germany. The conference site, Hotel Dreesen, is beautifully located at the Rhine river, with a scenic view of the surrounding wine lands and hills.

Scope: Technical areas covered by the Workshop include, but are not limited to –

- **Adaptive Methods**
- **Advanced FEM Techniques** Formulations, Solvers, Discrete Representations
- **Optimization Techniques, Parameter Space Sweep**
- **Time domain FEM** Theory and Applications
- **Mathematical Aspects of FEM**
- **FEM Applications** Antennas, Materials, Bio-electromagnetics, Electromagnetic Compatibility, Circuits and Circuit Boards
- **Hybrid Methods – Theory and Applications** FE-BI/FDTD, FE-FV/Circuit Simulators/High-Frequency Techniques, Coupled Physics FEM for RF-MEMS
- **FEM Applications** Waveguides, Components, Active Devices, Lumped Elements
- **Multigrid- and Domain Decomposition Methods**
- **CAD / Meshing Advances and Tools**
- **FEM Applications in Other Disciplines**

Abstract Submission: One-page abstracts of no more than 500 words are due by 25 January 2008.

General Chairs:

R. Dyczij-Edlinger, *Saarland University, Germany*

T. Eibert, *Universität Stuttgart, Germany*

General Co-Chair:

G. Pelosi, *University of Florence, Italy*

Technical Program Committee:

O. Farle (Chair), *Saarland University, Germany*

M. Loesch, *Saarland University, Germany*

P. Braun, *Saarland University, Germany*

Steering Committee: A.C. Cangellaris, *University of Illinois, Urbana, IL, USA*,

Z.J. Cendes, *Ansoft Co., Pittsburgh, PA, USA*, D.B. Davidson, *University of Stellenbosch, South Africa*, R.L. Ferrari, *Trinity College, Cambridge, UK*, J. Jin,

University of Illinois, Urbana, IL, USA, L. Kempel, *Michigan State University,*

MI, USA, J.F. Lee, *Ohio State University, Columbus, OJ, USA*, R. Lee, *Ohio*

State University, Columbus, OJ, USA, G. Pelosi, *University of Florence, Italy*,

M. Salazar-Palma, *Universidad Carlos III de Madrid, Spain*, T. Rylander,

Chalmers University of Technology, Sweden, J.L. Volakis, *Ohio State*

University, Columbus, OJ, USA, J.P. Webb, *McGill University, Montreal, PQ,*

Canada, J. Zapata, *Polytechnic University of Madrid, Spain*



Universität Stuttgart



IEEE MICROWAVE THEORY & TECHNIQUES SOCIETY
SOCIETY OF ENGINEERS





10th International Workshop on Finite Elements for Microwave Engineering

12-13 October 2010, New England, USA

<http://www.regonline.com/fem2010>

Abstract Submission Deadline: March 19, 2010

General: The International Workshop on Finite Elements for Microwave Engineering is a highly-focused biannual event. It provides an ideal meeting place for researchers who are active in either the theoretical development of finite element methods or their application to radio frequency and microwave engineering problems. All presentations will be oral.

Venue: The workshop will be held in the town of Meredith, New Hampshire, USA. The conference site, Mill-Falls Inns & Spa, is located on the beautiful shores of Lake Winnepesaukee with scenic views of New England's fall foliage.

Scope: Technical areas covered by the Workshop include, but are not limited to:

- **Adaptive Methods**
- **Advanced FEM Techniques** Formulations, Solvers, Discrete Representations
- **Optimization Techniques, Parameter Space Sweep**
- **Time Domain FEM** Theory and Applications
- **Mathematical Aspects of FEM**
- **FEM Applications:** Antennas, Materials and Meta-materials, Bio-Electromagnetics, Electromagnetic Compatibility, Circuits and Circuit Boards
- **Hybrid Methods – Theory and Applications:** FE-BI/FDTD, FE-FV/Circuit Simulators/High-Frequency Techniques, Coupled Physics FEM for RF-MEMS
- **FEM Applications:** Waveguides, Components, Active Devices, Lumped Elements
- **Multigrid and Domain Decomposition Methods**
- **CAD / Meshing Advances and Tools**
- **FEM Applications in Other Disciplines**

Abstracts: One-page abstracts of no more than 500 words are due by March 19, 2010.

Publication: Selected Workshop contributions will be published in a special issue of the journal *Electromagnetics*.

General Chairs:

M. N. Vouvakis, University of Massachusetts
D. Weile, University of Delaware

Technical Program Committee:

B. Shanker (chair), Michigan State University
R. W. Kindt (co-chair), US Naval Research Lab.

Scientific Committee (provisional): A. C. Cangellaris, University of Illinois

Urbana-Champaign, USA; Z. J. Cendes, Ansoft LLC., USA; D. B. Davidson, University of Stellenbosch, South Africa; R. Dyczij-Edlinger, Universität des Saarlandes, Germany; R. L. Ferrari, Trinity College, UK; J. Jin, University of Illinois, Urbana-Champaign, USA; L. Kempel, Michigan State University, USA; J.-F. Lee, Ohio State University, USA; R. Lee, Ohio State University, USA; G. Pelosi, University of Florence, Italy; T. Rylander, Chalmers University of Technology, Sweden; M. Salazar-Palma, Universidad Carlos III de Madrid, Spain; J. L. Volakis, Ohio State University, USA; J. P. Webb, McGill University, Canada; T. Weiland, Technische Universität Darmstadt, Germany; J. Zapata, Universidad Politécnica de Madrid, Spain.





11th International Workshop on Finite Elements for Microwave Engineering – FEM2012

June 4-6, 2012, Estes Park, Colorado, USA

<http://www.engr.colostate.edu/FEM2012>

FIRST CALL FOR PAPERS

Abstract Submission Deadline: Friday, January 6, 2012

General: The International Workshop on Finite Elements for Microwave Engineering is a highly-focused biannual event. It provides an ideal meeting place for researchers who are active in either the theoretical development of finite element methods or their application to radio frequency and microwave engineering problems.

Venue: The workshop will be held in The Historic Stanley Hotel, in Estes Park, Colorado – for information about the venue and social program, see the second page (turn the page).

Scope: Technical areas covered by the workshop include, but are not limited to:

- **Adaptive Methods**
- **Advanced FEM Techniques** Formulations, Solvers, Discrete Representations
- **Optimization Techniques, Parameter Space Sweep**
- **Time Domain FEM Theory and Applications**
- **Mathematical Aspects of FEM**
- **FEM Applications:** Antennas, Materials and Meta-materials, Bio-Electromagnetics, Electromagnetic Compatibility, Circuits and Circuit Boards
- **Hybrid Methods – Theory and Applications:** FE-BI/FDTD, FE-FV/Circuit Simulators/High-Frequency Techniques, Coupled Physics FEM for RF-MEMS
- **FEM Modeling:** Waveguides, Components, Active Devices, Lumped Elements
- **Multigrid and Domain Decomposition Methods**
- **CAD / Meshing Advances and Tools**
- **Design Using FEM and Hybrid Techniques**
- **FEM Applications in Other Disciplines**

Abstracts: One-page abstracts are due by Friday, January 6, 2012.

Publication: Selected workshop contributions will be published in a special issue of journal *Electromagnetics*.

General Chairs:

Branslav M. Notaros, Colorado State University

notaros@colostate.edu

Jian-Ming Jin, University of Illinois

j-jin1@ad.uiuc.edu

Technical Program Committee Chair:

Milan M. Blic, University of Belgrade and

Colorado State University

mblmhc@etf.rs

Scientific Committee (provisional):

A. C. Cangellaris, University of Illinois

Urbana-Champaign, USA; Z. J. Cendes, Ansoft LLC., USA; D. B. Davidson,

University of Stellenbosch, South Africa; R. Dyczaj-Edlinger, Universität des

Saarlandes, Germany; R. L. Fernal, Trinity College, UK; J. Jin, University of Illinois,

Urbana-Champaign, USA; L. Kempel, Michigan State University, USA; J.-F. Lee, Ohio

State University, USA; R. Lee, Ohio State University, USA; G. Pelosi, University of

Florence, Italy; T. Rylander, Chalmers University of Technology, Sweden; M. Salazar-

Palma, Universidad Carlos III de Madrid, Spain; J. L. Volakis, Ohio State University,

USA; M. N. Vouvakis, University of Massachusetts, USA; J. P. Webb, McGill

University, Canada; T. Weiland, Technische Universität Darmstadt, Germany; J.

Zapata, Universidad Politécnica de Madrid, Spain.



Turn the Page for Info about the Venue and Social Program



12th International Workshop on Finite Elements for Microwave Engineering – FEM2014

May 14-17, 2014, Mount Qingcheng, Chengdu, China

<http://www.FEM2014.org>

FIRST CALL FOR PAPERS

Abstract Submission Deadline: Friday, December 20, 2013

General: The International Workshop on Finite Elements for Microwave Engineering is a highly-focused biannual event. It provides an ideal meeting place for researchers who are active in either the theoretical development of finite element methods or their application to radio frequency and microwave engineering problems.

Venue: The workshop will be held in an upscale Howard Johnson Hotel, Mount Qingcheng, Chengdu, China.

Scope: Technical areas covered by the workshop include, but are not limited to:

- Fast Direct FEM Solver for Large Scale EM Analysis
- Advanced FEM Applications
- Advanced FEM and Hybrid Techniques
- Discontinuous Galerkin Methods
- Domain Decomposition Methods
- Engineering Design by FEM and Hybrid Techniques
- FEM Modeling of Microwave Devices, Nonlinear Medium and Devices
- Advanced FEM and Generalized FEM
- FEM Activities in China
- Moment Method and Integral Equation Solvers
- Higher order and Adaptive FEM Techniques
- Multi-Physics Modeling
- Multi-Scale and Fine-Scale Modeling
- Multigrid and Preconditioning Techniques
- Optimization Techniques and Parameter Space Sweep
- Parallel Algorithms on Multi- and Many-Cores Computers: Theory and Practice
- Time-Domain FEM

Abstracts: One-page abstracts are due by Friday, December 16, 2011.

Publication: Selected workshop contributions will be published in a special issue of journal *Electromagnetics*.

General Chairs:

Zaiping Nie, University of Electronic Science and Technology of China

znie@uestc.edu.cn

Jian-Ming Jin, University of Illinois

j-jin1@aduiuc.edu

Technical Program Committee Chair:

Jun Hu, University of Electronic Science and Technology of China (UESTC),

hujun@uestc.edu.cn

Scientific Committee (provisional): Dan Jiao, Purdue University, Juan

Zapata, M. Salazar-Palma and Luis Emilio Universidad Politécnica de

Madrid; Branislav Notaros, Colorado State University; Thomas Eibert,

Technische Universität München; Qing Hao Liu, Duke University; Lijun

Jiang, Hong Kong University; J.-F. Lee, Ohio State University; Zhen Peng,

University of New Mexico; B. Shanker, Michigan State University; Xing

Qing Sheng, Beijing Institute Technology; Amir Boag, Tel Aviv University;

Eric Michielssen, University of Michigan; Yin Wen Yan, Zhe Jiang

University; R. Dyezij-Edlinger, Universität des Saarlandes; Vitaliy Lomakin,

University of California at San Diego; Ali Yilmaz, University of Texas at

Austin; Rushan Chen, Nan Jing University of Science and Technology; Su

Yan, University of Electronic Science and Technology of China.



电子科技大学
University of Electronic Science and Technology of China



ILLINOIS
UNIVERSITY OF ILLINOIS AT URBANA-CHAMPAIGN



IEEE
MTT-S



AIP



13th International Workshop on Finite Elements for Microwave Engineering

May 16-18, 2016
Florence, Italy

The International Workshop on Finite Elements for Microwave Engineering is a highly-focused biannual event. It provides an ideal meeting place for researchers and practitioners active in the theory and application of the Finite-Element Method in RF and microwave engineering.

Jointly organized by the Politecnico di Torino and the University of Florence.

Venue The workshop will take place in the "Centro Arte e Cultura" at the heart of Florence, Italy - Scope Topics will include, but are not limited to: • Advanced FEM Techniques • Optimization Techniques, Model Order Reduction • Multigrid and Domain Decomposition Methods • Discontinuous Galerkin Methods • FEM for Multiphysics Problems • FEM for Metamaterials and Nanophotonics • Time Domain FEM • Adaptive methods • Hybrid Methods • FEM Modeling and Applications • CAD / Meshing Advances and Tools • Parallel Computation on Multi- and Many-Core Computers.

Selected papers will be published on a special issue of an international technical journal.

General Chairs

Roberto D. Graglia, Politecnico di Torino - Giuseppe Pelosi, University of Florence

Scientific Committee

• A. Boag, Tel Aviv Univ. (IL) • W. Cai, Univ. of N. Carolina (USA) • D.B. Davidson, Stellenbosch Univ. (RSA) • R. Dyczij-Edlinger, Univ. des Saarlandes (D) • T. Elbert, Tech. Univ. München (D) • G. Ghione, Polit. di Torino, (I) • R.D. Graglia, Polit. di Torino, (I) • L.-J. Jiang, Hong Kong Univ. (CN) • D. Jiao, Purdue Univ. (USA) • J.-M. Jin, Univ. of Illinois (USA) • J.-F. Lee, Ohio State Univ. (USA) • Q.H. Liu, Duke Univ. (USA) • B. Notaros, Colorado State Univ. (USA) • G. Pelosi, Univ. of Florence (I) • Z. Peng, Univ. of New Mexico (USA) • A. Peterson, Georgia Inst. of Tech. (USA) • C.J., Reddy, Altair (USA) • M. Salazar-Palma, Univ. Carlos III (E) • T. Sarkar, Syracuse Univ. (USA) • S. Selleri, Univ. of Florence (I) • B. Shanker, Michigan State Univ. (USA) • X.Q. Sheng, Beijing Inst. Tech. (CN) • J.L. Volakis, Ohio State Univ. (USA) • J.P., Webb, McGill Univ. (CDN) • S. Yan, Univ. of Elect. Sci. and Tech. (CN) • A. Yilmaz, Univ. of Texas (USA) • J. Zapata, Univ. Polit. de Madrid (E).



"Centro Arte e Cultura", conference location



"Centro Arte e Cultura" yard

"Uffizi" and "Palazzo Vecchio"



Important Dates

Paper submission: Dec. 18, 2015
Notification of acceptance: Jan. 22, 2016

Local Committee

• E. Agastra - Polytechnic of Tirana, Albania
• S. Maddio • M. Righini - University of Florence, Italy

Scientific Secretary

S. Selleri - University of Florence, Italy

info@fem2016.unifi.it
www.FEM2016.unifi.it



POLITECNICO
DI TORINO



UNIVERSITÀ
DEGLI STUDI
FIRENZE

DINFO
Dipartimento di
Ingegneria dell'Informazione

REPORTS OF PAST EDITIONS, FROM THE PAGES OF THE *IEEE Antennas and Propagation Magazine*



Reprinted with permission:

G. Pelosi "Report on the Second International Workshop on Finite-Element Methods in Electromagnetic-Wave Problems,"
IEEE Antennas and Propagation Magazine vol. 36, no. 4, 1994, pp. 60-61.

J.-F. Lee, S. Selleri, "Report on the 5th International Workshop on Finite Elements for Microwave Engineering,"
IEEE Antennas and Propagation Magazine vol. 43, no. 1, 2001, pp. 123.

D.B. Davidson, "Report on the 6th International Workshop on Finite Elements for Microwave Engineering: Antennas, Circuits & Devices,"
IEEE Antennas and Propagation Magazine vol. 48, no. 4, 2006, pp. 110-114

R. Mittra, "What's it Like in South Africa: You Have Questions? We Have Answers,"
IEEE Antennas and Propagation Magazine vol. 48, no. 4, 2006, p. 115

B.M. Notaroš, "Report on FEM2012,"
IEEE Antennas and Propagation Magazine vol. 55, no. 2, 2013, pp. 204-211.

J. Hu, N. Zaiping, "Report on FEM2014,"
IEEE Antennas and Propagation Magazine vol. 56, no. 4, 2014, pp. 170-176.

Report on the Second International Workshop on Finite-Element Methods in Electromagnetic-Wave Problems

Giuseppe Pelosi
 Scientific Secretary
 Microwave Laboratory
 Electrical Engineering Department
 University of Florence
 Via C. Lombroso 6/17
 50134 Florence, Italy
 Fax: +39554796767
 Email: pelosi@ingf1.ing.unifi.it

The Second International Workshop on Finite-Element Methods was held at the Certosa di Pontignano (Siena, Italy), May 24-26, 1994. The Workshop was jointly organized by the Electrical Engineering Department of the University of Florence (Italy), and the Department of Electrical Engineering of McGill University (Canada). The Co-Chairmen of the Workshop were Prof. M. Calamia and Prof. P. Silvester.

This was the second in a series of workshops, which began in May, 1992, at San Miniato (Pisa, Italy), just 50 years after the publication of Professor R. Courant's essay in which the Finite-Element Method was first described. The papers presented at this first Workshop appeared in a special issue of the Italian scientific journal, *Alta Frequenza*. This was appropriate, for the first paper to be presented on the use of finite elements in electronics, by Professor P. Silvester, appeared in that same journal (volume 38, pp. 3137, 1969), a quarter of a century earlier.

The Second Workshop was dedicated to the applications of finite elements to field problems, with emphasis on propagating fields and related devices: electromagnetic radiation, scattering, and related problems; guided waves; parameter determination for resonators and filters; active and passive microwave devices. Particular attention was devoted to industrial applications.

Some 100 participants, from Europe, North and South America, and Japan attended this Workshop, which provided a welcome forum for the exchange of status and experience in the area of finite elements. The meeting rooms at the Certosa di Pontignano were filled to capacity, and informal discussions continued well into the evening hours. The meeting was clearly timely, and of interest to many colleagues.

The workshop Proceedings were published in a special issue of *COMPEL* (volume 13, supplement A, May, 1994). They will prove of interest to engineers and scientists in electromagnetic CAD, as well as to software specialists in computational analysis and design. The illustration on the cover of the Workshop Proceedings was chosen to underline the methodological transition which has taken place this last century. From the first, exact solution of a scattering problem, obtained by Sommerfeld for the perfectly con-

ducting half-plane, the development of more and more powerful computers and of efficient numerical techniques has allowed analysis of the scattering from more and more complex geometrical and material configurations. A limited number of Proceedings of this Workshop are available by writing to the Scientific Secretary of the Workshop.

The number of papers presented at the Workshop was large, and all were of a high scientific level. Due to the limited duration of the workshop, the Steering Committee decided to organize parallel sessions. Invited contributions were presented by, among others, Prof. R. Mittra (University of Illinois, at Urbana), Prof. J. L. Volakis (University of Michigan), Prof. J. B. Davies (University College London), and Prof. P. Guillon (University of Limoges).

The Workshop organizers are grateful for the support lent by various institutions and establishments. Strong scientific support, for which the organizers wish to express their gratitude, was lent by the Italian National Research Council, the Institution of Electrical Engineers, the Institution of Electrical and Electronic Engineers (Central & South Italy Section MTT/AP Joint Chapter), and the University of Siena.

This Workshop has clearly filled a void in the range of specialist meetings on electromagnetics, and has led the Steering Committee to schedule a third meeting, to continue this series on a biennial basis. FEW96 is to be held in Halifax, Nova Scotia, Canada, July 9-11, 1996. You may wish to note this date in your calendar and plan to attend.

To obtain information about the third Workshop, send an e-mail message containing the words "send info" to FEW96@newton.ccs.tuns.ca or write to Dr. Z. D. Chen, Electrical Engineering Department, Technical University of Nova Scotia, PO Box 1000, Halifax, NS, Canada, B3J 2X4 (Fax: +19024227535). For details on how to submit a paper, send an e-mail message to FEW96@ingf1.ing.unifi.it, or write to Dr. G. Pelosi (Scientific Secretary of FEW96) at the above address.

See you in Halifax!

COMPEL

VOLUME 13 SUPPLEMENT A MAY 1994

Second International Workshop on Finite Element Methods in Electromagnetic Wave Problems

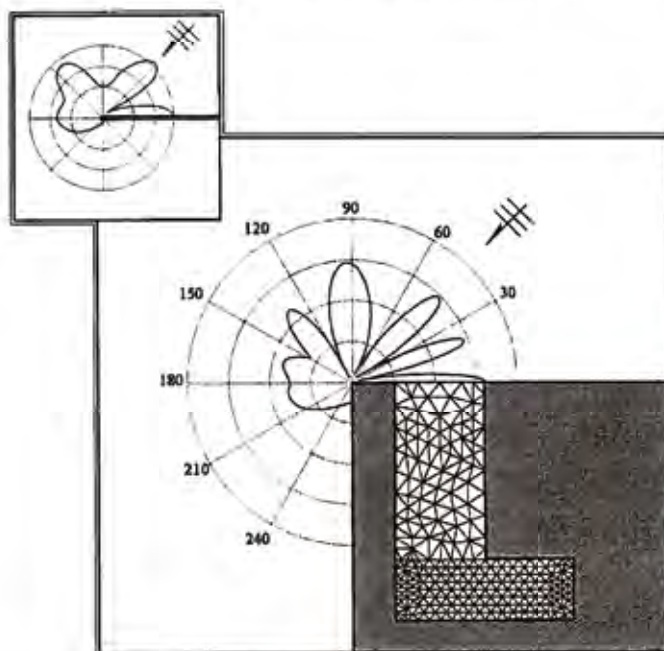

EDITORS: M. CALAMIA, G. PELOSI and P. SILVESTER



Figure 1. The front cover of the Workshop Proceedings.

Report on the 5th International Workshop on Finite Elements for Microwave Engineering

The 5th Workshop on Finite Elements for Microwave Engineering – Grand Challenges for New Millennium, co-organized by the Electrical and Computer Engineering Department, Worcester Polytechnic Institute, and the University of Florence, Italy, took place at John Hancock Conference Center, Boston, Massachusetts, USA on June 8-9, 2000. The co-Chairmen of the workshop were Prof. Z. J. Cendes (Ansoft Co., Pittsburgh, PA, USA) and G. Pelosi (University of Florence, Italy). The Scientific Secretaries were Prof. J. F. Lee (Ohio State University, Columbus, OH, USA) and Prof. R. Lee (Ohio State University, Columbus, OH, USA).

This was the fifth in a series of workshops that originated with the contribution of Prof. P. P. Silvester (McGill University, Montreal, Canada), and which were held in San Miniato (Pisa, Italy) in 1992, Siena (Italy) in 1994, Halifax (Nova Scotia, Canada) in 1996, and Poitiers (France) in 1998.

A selection of the papers presented at these workshops has been published in full length in dedicated special issues of international journals, the last of which is a freshly published special issue of the *International Journal of Numerical Modelling: Electronic Networks, Devices and Fields*, edited by P. Guillon, T. Itoh, G. Pelosi. It contains a selection of the papers presented in Poitiers ("Finite Elements for Microwave Engineering – From Electromagnetics to Microwave Electronics Software," *International Journal of Numerical Modelling*, 13, 2-3, March-June 2000, pp. 79-328). Further information can be found in the April, 2000, issue of this *Magazine* (42, 2, pp. 56-57).

The workshop provided an international forum for reporting and discussing recent progress and advances in the finite-element technologies for microwave engineering. Some 40 participants from Europe, North America, and Japan attended the workshop. The meeting room at the John Hancock Conference Center was crowded, and informal discussions continued well into the evening hours and during the social dinner. The meeting was clearly timely and of interest to many colleagues.

The papers presented at the workshop were relevant, and all of them were of a good level. Papers were divided into six sessions: "New Applications," "Waveguides," "Adaptive FEMs and Edge Elements," "FEM Modeling of Antennas," "Novel PDE Methods," and "Broadband Methods." Parallel sessions were carefully avoided, to allow participants to follow every contribution. As usual, full papers are being gathered to undergo a second revision and selection process. Chosen contributions will appear in a special issue of *Electromagnetics*, which is due in mid-2001.

The workshop organizers are grateful for the support lent by various institutions and establishments. Various institutions lent strong scientific support, for which the organizers wish to express their gratitude, for example, the Applied Computational Electromagnetic Society.

This workshop has clearly filled a void in the range of specialist meetings on electromagnetics, and this has led the Steering Committee to schedule a new meeting, to continue this series on a biennial basis. The 6th International Workshop on Finite Elements for Microwave Engineering – Antennas, Circuits, and Devices is planned for June 8-9, 2002, on the Island of Chios, Greece. The co-Chairmen will be Prof. J. L. Volakis and Prof. G. Pelosi; the Technical co-Chairs will be Constantine Balanis and Leo Kempel; the Local Chair will be Dimitra Kakkalmani. To obtain information about the conference site, please visit the Web at <http://www.chiosnet.gr>.

See you in Chios!

Jin-Fa Lee
ElectroScience Lab.
Dept. of Electrical Engineering
Ohio State University
1320 Kinnear Rd.
Columbus, OH 43212, USA
Tel.: +1 (614) 292-7270
Fax: +1 (614) 292-7297
Email: jinlee@ee.eng.ohio-state.edu

Stefano Selleri
Department of Electronics and Telecommunications
University of Florence
Via C. Lombroso 6/17
I-50134 Florence, Italy
Fax: +39 55-4796-767
E-mail: selleri@ingfi9.det.unifi.it

EM Programmer's Notebook



John L. Volakis
Rad. Lab., EECS Dept.
University of Michigan
Ann Arbor, MI 48109-2122
(734) 647-1797
(734) 647-2106 (Fax)
volakis@umich.edu (email)



David B. Davidson
Dept. E&E Engineering
University of Stellenbosch
Stellenbosch 7600, South Africa
(+27) 21 808 4458
(+27) 21 808 4981 (Fax)
davidson@ing.sun.ac.za (e-mail)

Foreword by the Editors

This month, our regular contributed column takes a break, due partly to both co-Editors and many potential contributors attending the 6th FEM Workshop on the Greek island of Chios.

Since John Volakis is a native of the island, it seems very appropriate to include a brief report on this conference in the place of the regular column.

Report on the 6th International Workshop on Finite Elements for Microwave Engineering: Antennas, Circuits & Devices

David B. Davidson

Some twelve years back, Giuseppe Pelosi (University of Florence) originated the first Finite Element Workshop for Microwave Engineering; he has continued his involvement as General co-Chair of all the workshops to date. This highly-focused biennial workshop has a tradition of moving around the world (the two previous ones that the author attended were held in Poitiers, France, and Boston, USA, respectively). The 6th International Workshop on Finite Elements for Microwave Engineering was held on the Greek island of Chios, in the northeast Aegean, from Thursday, May 30, to Saturday, June 1, 2002. Chios, although the birthplace of Homer, is one of the less well known of the Greek islands, despite some beautiful scenery (apparently, many wealthy ship owners live there, and endeavor to keep it from being overrun by tourists!); the locals are exceptionally friendly and hospitable.

Unfortunately, no one had reckoned with a wildcat strike by some transportation workers in Greece on the day preceding the conference, which left many delegates stranded around Athens Airport, with only the lunchtime flight operating. The lucky few who thus made it to the island by Wednesday evening did some quick thinking and postponed the first morning's session, giving the delegates now scattered around various hotels in Athens time to arrive on Thursday. The workshop thus got started after Thursday lunch. Some 64 papers, arranged in 16 sessions, were to be presented; there were 61 delegates from a host of countries, including

Canada, Denmark, France, Finland, Germany, Greece, Italy, Japan, Kuwait, Russia, Spain, South Africa, and the USA. The Greek and Italian delegations were the largest.

The following parallel sessions were arranged:

"Novel Techniques in FEM" (J. F. Lee and R. Lee)/"Special Topics I" (P. Lemos)

"FEM for Antennas I" (V. Makios and C. Soras)/"FEM Applications I" (D. B. Davidson)

"FEM Distributed/Parallel Computing" (I. S. Venieres)/"FEM Applications II" (F. J. C. Meyer)

"Hybrid Schemes for Microwave Component Modeling" (A. Cangelaris)/"Neural Networks/GA + FEM" (G. Pelosi and S. Selleri)

"Hybrid FEM I" (A. Monorchio)/"FEM for Antennas II" (J. Sahalos)

"Special Topics II" (T. Tsiouboukis)/"FE Design and Modeling of Optical Fibers/Waveguides" (M. Koshiba)



1. At the mayor's dinner (l-r): Jianming Jin, Nancy Webb, John Webb, and Jin- Fa Lee.



2. At the conference dinner (clockwise from left): Aihua Wood, Zoltan Cendes, Magdalena Salazar-Palma, Matthys Botha, David Davidson, Frans Meyer, and Jianming Jin.



3. Giuliano Manara (University of Piza, second from left), with his daughter and wife, and Giuseppe Pelosi (University of Florence, second from right) with his daughter.

"Higher Order Div-Conforming and Curl-Conforming Elements" (M. Salazar-Palma and Garcia-Costillo) "Special Topics III" (D. I. Kaklamani)

"Quasi-Static to Optical Applications in FEM" (G. Kyriacou) / "Hybrid FEM II" (J-M. Jin)

The technical program, put together by Technical co-Chairs Leo Kempel (Michigan State University) and Constantine Balanis

(Arizona State University), was very good, with most of world's experts in this field attending and presenting papers. Two parallel sessions were run, a departure from previous workshop practice. There was some debate about this, since given the focused nature of the workshop, many delegates frequently wanted to be in both sessions simultaneously!

However, the undoubted highlight of this workshop was the superb social program, organized by General co-Chair John Volakis and Local Committee Chair Dimitra Kaklamani, who have set a tough act for future organizers to follow. Unfortunately, most of us missed the dinner reception on Wednesday evening, due to the strike. However, we all turned out in force for the reception hosted by the Mayor on Thursday (Figure 1), as well as the dinner



4. The workshop Organizing Committee, in photo taken at the conference dinner. From left to right: Mrs. Bramou (travel office coordinator and workshop planner), Mr. Kostas Paidas (Chair, local tourist office), John Volakis (University of Michigan), Leo Kempel (Michigan State University), Giuseppe Pelosi (University of Florence), Constantine Balanis (Arizona State University), Dimitra Kaklamani (National Technical University of Athens), Christos Biniaris (graduate student at National Technical University of Athens, Web and workshop activities coordinator).



5. A scene in Mesta, one of the "mastic villages" in the south of the island.



6. Traditional Greek dancers at Emporios.



7. The black pebble beach at Emporios.



8. Demonstrating dancing at the conference dinner: Constantine Balanis (left) and Dimitra Kaklamani (right) with another guest.



9. John Volakis and Leo Kempel outside John's grade school in Olympi.

and local music on Friday evening (Figures 2-4), and the tour of the island on Saturday. This tour included most of the well-known sites on the island, such as the monastery Neo Moni, the medieval town Mesta (Figure 5), the "painted village" Pyrgi, and a memorable lunch and display of traditional Greek dancing at Emporios (Figure 6), with its black pebble beach (Figure 7). (Many of the Greek – and expatriate Greek – delegates impressed us with their dancing ability by spontaneously joining in the performances; special mention must be made here of Constantine Balanis' skills in this regard: see Figure 8!) The professional tour guide was most ably assisted by Vassilios Makios (University of Petras), whose knowledge of and passion for Greek history, culture, and dancing impressed all. As a bonus, the tour included a visit to John Volakis' home town, Olympi. I found this quite moving: John (or Ioannis, as we learnt to call him on the island!) took us around his hometown, including a visit to his grandparent's home, which he has recently renovated, as well as his grade school (Figure 9; now closed, due to the depopulation of the small villages on the island).

The 7th workshop will be held in Spain in 2004, with Magdalena Salazar-Palma (Madrid Polytechnic) as General co-Chair. The city of Madrid is the probable venue, although this has not yet been finalized. An offer has been made to host the 8th workshop in South Africa in 2006. ☺



David B. Davidson
 Dept. E&E Engineering
 University of Stellenbosch
 Stellenbosch 7600, South Africa
 (+27) 21 808 4458
 (+27) 21 808 4981 (Fax)
 davidson@ing.sun.ac.za (e-mail)

Foreword by the Editors

Very occasionally, we take a break from our regular contributed articles, and feature a related topic. In June, 2002, the column carried a report on the 6th FEM workshop on the Greek island of Chios, where John Volakis grew up. This month, we have a report on the 8th FEM workshop, held in David Davidson's home town, Stellenbosch.

[DBD] This is also the last EM Programmer's Notebook that John will be co-editing. With great foresight, John initiated the first column in the October, 1992, issue, and it has gone from strength

to strength as computational electromagnetics has continued to grow in importance as an increasingly crucial component of contemporary antenna engineering. John's duties as Director of the ElectroScience Laboratories keep him so busy at present that he has asked to pass on the mantle. From all of us in the community, on the *Magazine* staff, and especially from myself as co-editor since June, 1999, we would like to take the opportunity to profoundly thank John for all the contributions this column, his brain-child, has made.

General Chair's Report on the 8th International Workshop on Finite Elements for Microwave Engineering, Stellenbosch, South Africa, May, 2006

The eighth in this series of finite-element workshops was held in my hometown of Stellenbosch, South Africa, from May 25-26, 2006. The series dates back to 1992. The first workshop was entitled *Il Metodo degli Elementi Finiti Nelle Applicazioni dell'Elettromagnetismo* (National Workshop on Finite Elements in Electromagnetic Wave Problems), and was held in San Miniato (Pisa, Italy), May 26-27, 1992. It was organized by Giuseppe Pelosi, who has continued to serve as General Co-Chair for all subsequent workshops. The second workshop, held in Siena (Italy), May 24-26, 1994, was entitled the "International Workshop on Finite Elements in Electromagnetic Wave Problems."

This highly-focused biennial workshop has provided an ideal meeting place for researchers and practitioners active in the theory and application of the Finite-Element Method in RF and microwave engineering. Since its early inception in Italy, it has acquired a tradition of moving around the world. The third workshop was scheduled for Halifax (Nova Scotia, Canada), July 9-11, 1996, but was cancelled at the last minute (due to the deteriorating health of Peter Silvester). The fourth was held in Poitiers (France), July 10-11, 1998, and from this conference on, the name settled on the

current "International Workshop on Finite Elements for Microwave Engineering." The fifth was in Boston (Massachusetts, USA, June 8-9, 2000), the sixth was in Chios (Greece, May 30-June 1, 2002), and the seventh was in Madrid (Spain, May 20-21, 2004). This is the first time that the workshop was held in the southern hemisphere, at the Spier Wine Estate outside Stellenbosch. Stellenbosch itself is the second-oldest town in South Africa (founded in 1679), the center of the Western Cape wine lands (Spier is a working wine estate), and home of the University of Stellenbosch, the main organizer of the workshop. (The University of Stellenbosch grew out of the 19th century Victoria College, and became the University of Stellenbosch in 1918; it and the University of Cape Town are South Africa's oldest universities).

The technical program featured more than fifty papers, contributed from around the world. Delegates from the following countries attended: the USA, Germany, South Africa, the UK, France, Italy, Canada, Spain, Russia, and Sweden. Over 90% of the papers were contributed by international delegates, with authors from the USA alone contributing over 40% of the total submissions. The workshop provided an excellent overview of the current

state-of-the-art in finite-element research and applications at RF and microwave frequencies. This field continues to grow in importance across a broad spectrum of electronic-engineering applications. The following sixteen sessions were presented; the session organizers, who did an excellent job in assembling a fine technical program, are given in parentheses:

- Opening and Plenary Session (D. B. Davidson and G. Pelosi)
- FEM Applications: Antennas and Materials: Parts 1 and 2 (L. Kempel and F. J. C. Meyer)
- FEM Applications: Waveguides, Components, Active Devices, Lumped Elements (R. Mittra, S. Selleri)
- Multi-Grid and Domain Decomposition Methods: Part 1 and 2 (A. C. Cangellaris, J.-F. Lee)
- Adaptive Methods (R. Dyczij-Edlinger, J. P. Webb)
- Advances in Absorbing and Periodic Boundary Conditions (M. M. Botha, J.-M. Jin)
- Advances in Discrete Representations (M. M. Botha, J.-M. Jin)
- Advances in FEM Formulations and Solvers (M. M. Botha, J.-M. Jin)
- Special Session in Honor of P. P. Silvester (R. L. Ferrari)
- Time-Domain FEM: Parts 1 and 2 (J. S. Hesthaven, T. Rylander)
- Hybrid Methods (R. Lee, J. L. Volakis)
- Optimization Techniques, Parameter Sweep Space: Parts 1 and 2 (G. Pelosi, J. Zapata)

There was a very notable increase in time-domain FEM work: at the Chios meeting in 2002, there were perhaps two papers on the topic; this year, there were two dedicated time-domain sessions. There was also a steady increase in hybridization: whilst the FEM/MoM is classic, we also saw a number of FEM/FDTD hybrids at this meeting. Also gratifying was an increase in interest from the applied math community. Finally, we should mention that it was indeed an august community attending, including several IEEE Fellows and no less than three past AP-S Presidents (Figure 1).

A highly unusual feature for a technical meeting was a visit by two hand-reared cheetahs to the conference venue during the second morning! An unscheduled break in one session was hastily arranged so that these magnificent animals could be admired (Figures 2, 3).

Since the Chios workshop in 2002, the FEM workshops have had a tradition of full days of technical presentations, followed by an equally full social program, and this year was no exception. Delegates were welcomed at a cocktail party on Wednesday evening. At the end of the first day (Thursday), wine-tasting at the neighboring Kleine Zalze estate was followed by a memorable dinner at the Terroir restaurant (Figure 4), currently one of the top ten



Figure 1. John Volakis makes a point during his talk (photo by Leo Kempel).



Figure 2. Don't try to outrun these big cats during their guest appearance at the conference... (photo by S. Selleri).



Figure 3. ...or wake them up during a rest in their enclosure! (photo by L. Kempel).



Figure 4. At Terroir (CCW from left): Rick Ziolkowski, Amor Davidson, Jon Webb, Ron Ferrari, Nancy Webb, John Volakis, and John and Sue Cloete.



Figure 7. The “kwela” band entertaining us at Moyo (photo by Leo Kempel).



Figure 5. Ron Ferrari (face painting care of Moyo) tries an unusual African teapot during the Moyo banquet.



Figure 6. David and his wife, Amor, at Moyo (photo by Rick Ziolkowski).



Figure 8. Cape Point: Any further south and the conference General Chair, David, would have been all at sea (photo by L. Kempel).

in South Africa. The banquet that finished the workshop on Friday evening was something very different. It was held at Moyo (Figures 5, 6) at Spier, the theme of which is contemporary African, and accommodated in marquee tents (and in summer, in tree houses, which unfortunately wasn't an option in this late autumn date in the southern hemisphere). Delegates were treated to a massive buffet of typically Southern African cuisine, and entertained by both a “kwela” band and traditional dancers (Figure 7).

This, however, was not the end of the social activities. The Saturday post-conference tour went down the Cape Peninsula to the Indian Ocean Point (Figure 8), often seen as the meeting point of the Indian and South Atlantic Oceans. The Cape has a Mediterranean climate, with winter rainfall. The weather was delightful for the start of the conference (indeed, many were heard, shortly after arriving, to ask the locals, "Are you sure this is your winter?"), but our luck partly failed on Saturday, with a cold front blowing through. Fortunately, other than not being able to go up Cape Town's famous Table Mountain in the cable car, a great tour was nonetheless had.

Ten years ago, Peter Silvester, one of the pioneers in this field, very sadly passed away at the peak of his professional life. At this workshop, we had a special session to commemorate his work, organized by his friend and colleague Ron Ferrari. Additionally, we collated Peter's lifetime publications, which were included in a book of abstracts. (This book may be downloaded from the conference Web site: <http://courses.ee.sun.ac.za/FEM2006/>). Three very interesting and diverse papers were presented: Ron Ferrari discussed Peter's many contributions to *integral-equation* methods (most 25% of Peter's papers were on this topic); Jon Webb discussed Peter's pioneering work on the FE modeling of electrical machines – the rather chilly reception it received at the time seems believable nowadays; and Stefano Selleri reviewed Peter's fundamental paper on waveguide eigenanalysis, published in the Italian national journal *Alta Frequenza* in early 1969 (Figure 9).

A new feature of this workshop was a plenary talk, which Raj Mitra kindly agreed to present (Figure 10). Raj also entertained us during the Terroir dinner with a number of questions visitors to South Africa are reputed to ask locals, and their hilarious replies: the full text of these appears elsewhere in this issue.

For some unknown reason, recent FEM workshops seem to have acquired a tradition of attracting unforeseen local problems to accompany the meetings. In 2000, the organizers of the Boston workshop had to contend with the "Big Dig;" in 2002, a wildcat strike at Athens airport stranded delegates heading for Chios; in 2004, the organizers had a royal wedding in Madrid as competition; and continuing the tradition, we had to reckon with potential power outages due to problems on the South African grid, especially in the Western Cape. Fortunately, the backup generators and 'Ses arrangements proved unnecessary during the meeting!



Figure 9. Stefano Selleri reviews Peter Silvester's pioneering 1969 *Alta Frequenza* paper in the commemorative special session (photo courtesy S. Selleri).



Figure 10. Raj Mitra delivers his plenary address.



Figure 11. The local organizing committee (l-r): Matthys Botha, David Davidson, and Hannelle van Wyk.



Figure 12. Rick Ziolkowski visits Spler's raptor program (photo courtesy Rick Ziolkowski).



Figure 13. The Big Five in one day (photo courtesy R. W. Ziolkowski and J. A. G. Malherbe).

From myself as General Chair, a special word of thanks to the Technical Program Chair, Matthys Botha, and the Conference Administrator, Hannelie van Wyk (Figure 11). These formal titles do not fully reflect the diverse fields in which they contributed to ensure the success of this event. Many thanks also to our sponsors. Ansoft Corporation; EM Software & Systems; the European Office of Aerospace Research and Development (of the Air Force Office

of Scientific Research, United States Air Force Research Laboratory); and the South African Joint AP/MTT Chapter of the IEEE; together provided generous financial sponsorships. The IEEE Antennas and Propagation and Microwave Theory and Techniques Societies assisted with technical co-sponsorship. Rick Ziolkowski (Figure 12), immediate Past President, represented the IEEE AP-S at the workshop. He delivered a very touching speech welcoming delegates during the opening session, noting the contributions to electromagnetics in South Africa made by Professors Johannes Cloete and Jan Malherbe: as Rick commented, the conference was organized largely by their technical "children" and "grand-children." Rick also went on to bag the "Big Five" in one day in the Kruger National Park following the conference (Figure 13)!

A large number of the delegates were visiting South Africa for the first time. Since the momentous political changes of the early 1990s, South Africa has stepped back firmly onto all aspects of the world stage. The country has much to offer visitors, and a number of delegates combined their visit to South Africa with trips to game parks, the Garden Route and, of course, Cape Town and surrounds. In closing, two notes for the future. Firstly, South Africa is hosting the 2010 FIFA World Cup: we hope a number of delegates will consider returning for this event! Secondly, it is planned that the 9th FEM workshop will be held in Germany in 2008, to be jointly organized by the Universities of Saarland and Stuttgart.

David B Davidson
General Chair ✉

What's it Like in South Africa: You Have Questions? We Have Answers

On a recent visit to South Africa, I picked up these Q&A gems while chatting with people there about how some foreign tourists ask the natives questions about the country, and how the South Africans respond to them (tongue in cheek, of course). I hope you'll enjoy them as much as the audience did when I gave my little spiel after one of the FEM'06 conference dinners. Our South African hosts were in stitches, as were the other guests when they heard them. By the way, we found that South Africa is a very modern country, but, of course, there also have great safari destinations, such as the Kruger National Park, which you can enjoy. Also, I might add that South African people are very charming and hospitable. We really enjoyed our visit to Stellenbosch, as well as the safari several of us went to, before and/or after the FEM meeting.

Q: Does it ever get rainy and windy in South Africa? I have never seen it rain on TV, so how do the plants grow?

A: We import all plants fully grown and then just sit around watching them die.

Q: Can you give me some information about koala bear racing in South Africa?

A: Aus-tra-lia is that big island in the middle of the Pacific. Africa is the big triangle-shaped continent south of Europe, which does not...oh, forget it. Sure, the koala bear racing is every Tuesday night in Hillbrow, Johannesburg. Come *au natural*, or at least use ostrich feathers.

Q: Do I need to bring cutlery into South Africa?

A: Why? Just use your fingers like we do.

Q: Which direction is north in South Africa?

A: Face south and then turn 90°. Contact us when you get here and we'll give you the rest of the directions.

Q: I want to walk from Durban to Cape Town: can I follow the railroad tracks?

A: Sure, it's only 2,000 kilometers: take lots of water, plus a case or two of South African wine.

Q: Will I be able to see lions and elephants in the street?

A: Depends how much you've been drinking. You need at least one bottle of South Africa wine or one-half bottle of Amarula (a liqueur made from indigenous South African fruit) to get started.

Q: Is it safe to run around in the bushes in South Africa?

A: Sure, but wear dark clothes in case you run into a lion and wet your pants.

Q: Are there any ATMs (cash machines) in South Africa? Can you send me a list of them in Johannesburg, Cape Town, Knysna, and Jeffreys Bay?

A: Sorry, can't do: we don't use ATMs in South Africa. We just walk up to tourists like you and ask them to hand them their money. We take Euros, pounds, dollars, and even credit cards: we are not fussy.

Raj Mittra
319 Electrical Engineering East
The Pennsylvania State University
University Park, PA 16802 USA
E-mail: Mittra@enr.psu.edu

Report on FEM2012

The 11th International Workshop on Finite Elements for Microwave Engineering – FEM2012 was held from June 4-6, 2012, in Estes Park, Colorado, USA. It was organized by Colorado State University (CSU), Fort Collins. The FEM international workshops are highly focused biannual events, providing an ideal meeting place for researchers who are active in either the theoretical and numerical development of finite-element and hybrid methods, or their application to a broad range of electromagnetic problems. Previous workshops were held in Sienna, Italy, in 1992 and 1994; Poitiers, France, in 1998; Boston, Massachusetts, USA, in 2000; Chios, Greece, in 2002; Madrid, Spain, in 2004; Stellenbosch, South Africa, in 2006; Bonn, Germany, in 2008; and Meredith, New Hampshire, USA, in 2010.

At FEM2012, we had about 100 attendees (Figure 1), equally split between US and non-US participation. Thirteen countries were represented: Austria, Canada, China, France, Germany, Italy, Poland, Serbia, South Africa, Spain, Sweden, Turkey, and United States. The delegates came to Estes Park from 47 cities and towns on four continents.

The workshop took place in the Stanley Hotel (Figure 2), a historic landmark hotel in a spectacular mountain-view location, offering old-world charm within the sight of the Rocky Mountain National Park. Located in Estes Park (Figure 3), one of the most beautiful resort towns in the US (an hour from Fort Collins, and an hour and one-half from Denver International Airport), the hotel was built in 1907-1909 by F. O. Stanley, the inventor (in 1897) of the Stanley Steamer automobile (on display in the hotel lobby). It inspired Stephen King to write *The Shining*, and served as a location site for several movies (including some of my favorites, such as “Dumb and Dumber”).

It hosted many US Presidents, royalties, and celebrities. Many believe that the hotel is haunted (the most cases of ghostly activity were reported for the MacGregor Ballroom, in which we had our conference banquet).

The FEM2012 Technical Program combined 82 papers organized in 12 special sessions, as follows (the session organizers, who did a wonderful job in securing top-quality papers and most reputable presenters, and also served as session chairs, are given in parentheses):

- S1 “Modeling and Design of Antennas and Arrays Using FEM”
(R. Kindt, D. Filipovic, E. Topsakal)
- S2 “Discontinuous Galerkin Methods”
(Q. H. Liu, W. Cai)
- S3 “Time-Domain FEM and Applications”
(D. White, O. Biro, T. Rylander)
- S4 “FEM and CEM Applications in Optics and Nanophotonics”
(E. Simsek)
- S5 “Model-Order Reduction Techniques”
(R. Dyczij-Edlinger, V. de la Rubia)
- S6 “Advances in Vector Bases for CEM”
(R. Graglia, A. Peterson, D. Wilton)
- S7 “FETD Modeling of Complex Media and Structures”
(R. Lee, F. Teixeira)



Figure 1. Participants of the 11th International Workshop on Finite Elements for Microwave Engineering (FEM2012) are seen here working hard on increasing their red blood-cell counts at 12,183 ft (3,713 m) above the sea level, during their trip to the nearby Rocky Mountain National Park. This was on the third day of the workshop. Practically all participants were AP-S members.



Figure 2. FEM2012 was held in the Historic Stanley Hotel (famous for Stephen King's *The Shining*), located at an elevation of 7,500 ft (2,286 m) in Estes Park, Colorado. Standing in the front is Milan Ilić, FEM2012 Technical Program Committee Chair.



Figure 4. The FEM2012 session on “Modeling and Design of Antennas and Arrays Using FEM,” in the Billiard Room of the Stanley Hotel on the morning of June 4, 2012. Mr. F. O. Stanley was reported to have been periodically seen in this room. We had great attendance, equally split between the two conference rooms during the entire workshop.



Figure 3. FEM2012 attendees are shown ready for an evening walk in Estes Park, on June 5, 2012 (l-r) Jianming Jin, Andy Peterson, Marinos Vouvakis, B. Shanker, Rob Lee, Branislav Notaroš, Eric Lucas, Joanne Wilton, Don Wilton, Milan Ilić, and Olivera Notaroš.



Figure 5. The FEM2012 session on “Discontinuous Galerkin Methods” in Stanley's Music Room, going on in parallel with the session in Figure 4. This room had the original piano that was played on several occasions by famous American composer and conductor John Philip Sousa (“The Stars and Stripes Forever”); it was also reported to play on its own.

- S8 “Adaptive FEM, Higher-Order Bases, and Advanced FEM Formulations”
(J. Webb, M. Gavrilovic, M. Salazar Palma, L. Garcia-Castillo)
- S9 “Advances in Hybrid Methods and Multiphysics Problems”
(B. Shanker, L. Kempel)
- S10 “FEM Modeling and Applications of Metamaterials and Periodic Media”
(K. Sertel, J. Volakis)
- S11 “Domain-Decomposition Methods”
(J.-F. Lee, Z. Peng)
- S12 “Advanced FEM/MoM Modeling, Design, and Optimization”
(C. J. Reddy, U. Jakobus, J. Zapata, J. Gil, D. Jiao, A. Cangellaris)

The talks ran in two parallel tracks in the historic Billiard Room (Figure 4) and the elegant Music Room (Figure 5), in two completely packed conference days, June 4 and 5, 2012. One track was predominantly dedicated to novel finite-element and hybrid methods, including sessions on vector basis functions, higher-order elements, domain-decomposition methods, discontinuous Galerkin methods, adaptive FEM, hybrid formulations for multiphysics problems, and model-order reduction techniques. The other track mostly covered a variety of cutting-edge applications of FEM and related computational techniques, including FEM modeling and design of antennas and arrays, metamaterials and periodic media, time-domain modeling of complex media and structures, applications in optics and nanophotonics, and optimization techniques. We had great and uniform attendance at all talks in both rooms. The FEM2012 *Book of Abstracts* is available electronically at <http://www.engr.colostate.edu/FEM2012>.

As a new feature, FEM2012 introduced the following series of open-forum discussions. These were moderated by leading FEM researchers and practitioners from academia, industry, and government, and held on the afternoon of the third day of the workshop, June 6, 2012:



Figure 6. A novelty of FEM2012 was a series of three open-forum discussions on the last afternoon (after our trip in Figure 1). The discussion on “FEM and CEM Bases, Elements, and Formulations” was moderated by Jon Webb, Andy Peterson, and Don Wilton.



Figure 7. However, as always, the best pieces of one-on-one discussion took place during the breaks, over cookies and coffee/tea in the Piñon Room, or in the main lobby of Stanley (see the Stanley Steamer in the back), as well as on the veranda outside.



Figure 8. The ten student winners of the newly established FEM2012 Student Paper Competition received student travel support grants sponsored by the US Army Research Office and were recognized at the conference banquet: (from second left to second-to-the last on the right) Thomas Bauernfeind, Stylianos Dosopoulos, Grzegorz Fotyga, Qing He, Gergely Koczka, Ana Manić, Safa Salman, Nada Šekeljić, Ming-Feng Xue, and Wang Yao. On the left is Jianming Jin and on the right is Branislav Notaroš, FEM2012 General Chairs.



Figure 9. A battle of the bands: the FEM2012 conference banquet was a very pleasant and entertaining event in spite of the workshop Chair's long speech and his repeated attempts to be funny. The success was thanks to the great playing by the Fort Collins Jazz and Blues Band, led by Tony DeNardo. Reportedly, the Stanley Hotel's ghosts (who you of course can't see in this picture) were the only ones dancing during the official banquet and laughing at workshop Chair's jokes (however, the dancing floor "exploded" afterwards).



Figure 10. Olivera Notaroš, an ECE faculty member at Colorado State University, headed the FEM2012 Local Organizing Committee, shown here.



Figure 11. The FEM2012 welcome reception on the evening of June 3, 2012, was a great opportunity to start conversations among old and new friends.



Figure 12. This is why our professional conferences are an invaluable and irreplaceable component of our building of research agendas, awareness, teams, and professional friendships. Shown are lively exchange of ideas over a lunch in Stanley's MacGregor Ballroom. Two past AP-S Presidents and a number of future presidents can be seen in the picture.

D1 "Open Forum Discussion on FEM and CEM Bases, Elements, and Formulations"
(Moderators: A. Peterson, D. Wilton, J. Webb, K. Sertel)

D2 "Open Forum Discussion on DDM, MOR, and Efficient FEM and Hybrid Solutions"
(Moderators: J.-F. Lee, Z. Peng, R. Dyczij-Edlinger, V. de la Rubia)

D3 "Open Forum Discussion on FEM-Based Modeling, Design, and Applications"
(Moderators: L. Kempel, B. Shanker, R. Kindt, C.J. Reddy, K. Zhao, T. Euler)

We had a completely full room for these discussions (Figure 6), which turned out to be extremely useful and engaging. Many colleagues said that they had not seen open-forum discussions like these at any of our professional conferences. However, everyone thought that they were a great idea because one had a lot more discussion than at regular paper presentations, and everyone wanted to keep them for future FEM workshops. Of course, nothing surpasses one-on-one discussions during breaks (Figure 7) and social events.

The first open forum featured a very lively and detailed discussion in response to two main questions posed by the moderators: "Higher-order bases: do we need them? If so, why aren't they more widely used?" and "Special elements (singular basis functions, basis functions incorporating plane waves, etc.) are widely used in disciplines like mechanics; why aren't they being more widely proposed for computational electromagnetics (CEM)?" One of the common threads of the entire discussion may be expressed as follows. Academics want to explore new ideas (such as higher-order basis functions), whereas commercial software companies want to be able to assume that their users need to know almost nothing to use the software.

The second forum discussed such domain-decomposition methods as "divide-and-conquer" approaches. The discontinuous Galerkin technique was pointed out as an enabling technology for the use of the best solver for each part of the problem. Model-order-reduction approaches were identified as smart ways to recover the minimal information necessary to describe an electromagnetic system.



Figure 13. FEM conversations to the very end: FEM2012 was closed with the chuck-wagon dinner and cowboy show in the Elkhorn Lodge on June 6, 2012. This was a true Old West setting, including rustic metal plates (such as the one held by Roman Dyczij-Edlinger in the picture), in the oldest continually occupied structure in Colorado.



Figure 15. A visit to the Continental Divide, the un-drawn line traversing all of the Americas to separate drainages to the Atlantic and the Pacific. Branislav Notaroš is shown pointing to the Cache la Poudre Creek, which eventually joins the Missouri and Mississippi Rivers and reaches the Gulf of Mexico. Robert Kotiuga is pointing to the start of the mighty Colorado River, which makes the Grand Canyon on its way west to the Gulf of California.



Figure 14. FEM2012 participants are shown on the really spectacular tour of Rocky Mountain National Park, one of the oldest and most visited national parks in the US, on June 6, 2012. This was a narrated bus ride along the Trail Ridge Road, which is the highest continuous motorway in the US. All technical sessions were completed, all as well, and everyone seemed to be happy and sound, so the workshop Chair could finally relax for a nice snooze on the bus.



Figure 16. FEM2012 participants are shown using their conference gifts – binoculars (with engraved FEM2012 logos) – for a closer look at nearby mountain peaks, some reaching almost “14k” (thousand feet): (front) Luis Garcia-Castillo, Valentin de la Rubia, Milica Notaroš, and Jelena Notaroš; (back) B. Shanker, Jasmine Lee, Jin-Fa Lee, Marinos Vouvakis, and Andy Peterson.



Figure 17. Shown feeling like on the top of the world during their visit to the “Land Above the Trees,” with fascinating alpine tundra landscapes: (l-r) Joanne Wilton, Stylianos Dosopoulos, Milan Ilić, Branislav Notaroš, and Valentin de la Rubia. On the way back down, we saw some beautiful Rocky Mountain bighorn sheep, also called rams (the ram is the official mascot of CSU), elk, deer, and owls.



Figure 18. The trip culminated with a picnic lunch and a hike of the Roaring River (my absolutely most favorite spot in the park), displaying the equally magnificent and destructive power of nature. At 5:30 a.m. on July 15, 1982, the earthen Lawn Lake Dam at the top of the mountain collapsed, releasing a rushing 10 m-high flood wave downhill. A trash collector heard the crashing waters and alerted dozens of nearby campers, but unfortunately three campers did not succeed in climbing to safety.



Figure 19. Many of the “flying” boulders carried by the roaring flood wave on the morning of July 15, 1982, were much larger than a car. They are now deposited on the banks of the Roaring River. The picture shows FEM2012 attendees hiking the river banks: (standing) Nada Šekeljić, Nil Apaydin, Sanja Manić, Eric Lucas, Stylianos Dosopoulos, José Gil, and Ana Manić; (sitting on the top of a huge “flying” boulder) B. Shanker, Mahadevan Ganesh, and Marinos Vouvakis.

The third forum started with a discussion of FEM-based analysis and design relative to applications involving micro-scale, macro-scale, and multi-scale models, and rapidly grew into an extremely dynamic and useful exchange of ideas on future directions for the community. This included lots of good comments and suggestions by the attendees on how to revitalize CEM research and to renew student interest in the discipline; how to identify open problems of greatest practical and societal relevance, and approach them as the community in a concentrated synergistic research effort; and how to proactively promote and advertise our effort and agenda to funding agencies and other communities. The notes of the three open-forum discussions (taken by Andy Peterson, and then edited by several others) were later posted on the FEM2012 Web site, with an opportunity for the participants to add their comments in a blog fashion.

As another new feature, ten student winners of the FEM2012 Student Paper Competition received student travel support grants sponsored by the US Army Research Office. The student awardees, coming from several countries, presented their winning papers at the workshop, and were recognized at the conference banquet (Figures 8 and 9).

It is a great tradition of FEM International Workshops to provide extremely rich social programs for the delegates. The program prepared by the FEM2012 Local Organizing Committee (Figure 10) started with a welcome reception on the evening of June 3, 2012 (Figure 11). The program filled prac-

tically every hour of free time not used for paper sessions and open discussions during the following three days (Figure 12). Many workshop participants were delighted with the specially organized and guided Stanley Hotel Ghost & History Tours. These featured the beginnings of the hotel; the Stanley's most-haunted rooms; and places including Stephen King's room 217, where the creation of *The Shining* began; the underground tunnel; etc.

The FEM2012 closing reception on the evening of June 6, 2012 featured a unique western experience – a chuck-wagon dinner and cowboy show – at the Elkhorn Lodge & Ranch, Estes Park (Figure 13). The highlight of the social program was the trip to the Rocky Mountain National Park on June 6, 2012 (Figures 14-19). Because of the great interest, we had to introduce a second bus for the trip.

On behalf of all FEM2012 authors and participants, I would like to thank Jianming Jin, Milan Ilić, and Olivera Notaroš, whose help and support on the FEM2012 Organizing Committee were essential in all stages of the preparation and running of the workshop. Special thanks go to ANSYS (ANSOFT), CST (Computer Simulation Technology), and to EM Software & Systems SA (Pty.) Ltd. (FEKO). Thanks also to Colorado State University, the generous financial sponsorships from which enabled us to enrich the social program described in this report. The US Army Research Office is thanked for making the Student Paper Competition and Awards possible. The IEEE Antennas and Propagation Society, IEEE Microwave Theory and Techniques Society, URSI, and University of Illinois assisted with gracious technical sponsorships.

It was my great pleasure to be of service to the FEM and CEM community, to lead the organization of FEM2012, and to host so many great researchers and colleagues in Estes Park last summer. Many international attendees visited the US for the first time. Many US attendees visited Colorado for the first time. Almost all FEM2012 delegates visited Estes Park for the first time. To all: please visit again! I hope to see you all and many others at our next workshop, FEM2014, to be held in Chengdu, China.

Branislav M. Notaroš
FEM2012 General Chair
E-mail: notaros@colostate.edu

Report on FEM2014

The 12th International Workshop on Finite Elements for Microwave Engineering – FEM2014 – was held from May 14 to 17, 2014, in Mount Qingcheng, Chengdu, China. It was organized by the University of Electronic Science and Technology of China (UESTC) and the University of Illinois at Urbana-Champaign (UIUC), cosponsored by the Electronic Information Control Key Laboratory at Chengdu, International Joint Research Project (“111” Project), Computational Electromagnetics Chapter of Chinese Computational Physics Society, IEEE Chengdu Section, IEEE AP/EMC Joint Chengdu Chapter, and Antenna Society of Chinese Institute of Electronics, and technically cosponsored by the Nanjing University of Science and Technology (NJUST), Beijing Institute of Technology (BIT), and the University of Hong Kong (HKU).

The International Workshop on Finite Elements for Microwave Engineering is a highly focused biannual event. It provides an ideal forum for researchers to share their experience and achievements with the theoretical development and practical applications of finite-element methods to radio-frequency and microwave engineering problems. Previous workshops were held in Sienna, Italy, in 1992 and 1994; Poitiers, France, in 1998; Boston, Massachusetts, in 2000; Chios, Greece, in 2002; Madrid, Spain, in 2004; Stellenbosch, South Africa, in 2006; Bonn, Germany, in 2008; Meredith, New Hampshire, in 2010; and Estes Park, Colorado, in 2012.

FEM2014 had 125 attendees from ten countries: USA, Belgium, Germany, Israel, Poland, Singapore, South Africa, Spain, Switzerland, and China (including Hong Kong). The delegates came to Mount Qingcheng from 49 institutions on four continents, with 89 papers accepted for oral representation, including 46 papers from overseas.

The workshop took place in the Qingcheng (Howard Johnson) International Hotel (Figures 1 and 2), located at the foot of Mount Qingcheng, one of the birthplaces of Chinese Taoism. Mount Qingcheng (Figures 3 and 4) has numerous Daoist temples and sites along the paths to its peak. The area is green all year around, and is known for its secluded tranquility. With its annually average temperature of 15°C, Mt. Qingcheng has a humid subtropical monsoon climate. It is reputed as “Dong Tian Fu Di” (which means a wonderful mountain and happy place) and “the fairyland on Earth.”

The FEM2014 technical program was organized into the following 13 special sessions (the session organizers, who secured top-quality papers and also served as session chairs, are listed in parentheses):

- S1 Advanced FEM and Hybrid Techniques
(Branislav Notaros, Thomas Eibert)
- S2 Domain Decomposition Methods
(Jin-Fa Lee, Zhen Peng)
- S3 Discontinuous Galerkin Methods
(Qing-Huo Liu, Li-Jun Jiang)
- S4 Moment Method and Integral Equation Solvers I
(Amir Boag, Eric Michielssen)
- S5 Multi-Physics Modeling
(Wen-Yan Yin)
- S6 Advanced Computational Modeling and Applications
(Zhi-zhang Chen, Jun-Hong Wang)
- S7 CEM Activities in China
(Xin-Qing Sheng, Ming-Yao Xia)
- S8 Advanced FEM and Generalized FEM
(Balasubramaniam Shanker, Raphael Kastner)
- S9 Moment Method and Integral Equation Solvers II
(Magdalena Salazar-Palma, Mei Song Tong)
- S10 Fast Direct FEM Solver for Large Scale EM Analysis
(Haixin Liu, Qing He, Dan Jiao)
- S11 Time-Domain FEM
(Ru-Shan Chen, Su Yan)
- S12 Parallel Algorithms on Multi- and Many Cores Computers: Theory and Practice
(Vitaliy Lomakin, Ali Yilmaz)
- S13 Optimization Techniques and Parameter Space Sweep
(Romanus Dyczij-Edlinger, Sheng Sun)

The presentations ran in two parallel tracks in two adjacent halls: Taian Hall (Figure 5) and the Longchi Hall (Figure 6), in two completely packed conference days, May 15 and 16, 2014. These tracks covered a variety of cutting-edge applications of FEM and related computational techniques, including advanced finite-element and hybrid techniques, domain-decomposition methods, discontinuous Galerkin methods, generalized FEM, multi-physics modeling, direct solvers, optimization techniques, and parameter space sweep. The attendance was excellent and uniform at all presentations in both rooms.

A special commercial-software show was also arranged in Dagan Hall in the afternoon of May 16, in order to provide students and colleagues in computational electromagnetics an opportunity to learn the latest advances in leading commercial software. Dagan Hall was located on the same floor, and so it was very convenient for attendees to join. The representatives from ANSYS, CST, FEKO, and Science Park of UESTC introduced their recent progress.



Figure 1. The FEM2014 hotel: Howard Johnson Conference Resort Chengdu, located at the foot of Mount Qingcheng, one of the birthplaces of Chinese Taoism.



Figure 4. Beautiful Lake in Mount Qingcheng.



Figure 2. The FEM2014 restaurant: Maya Cafe in Howard Johnson Conference Resort Chengdu, where breakfast, lunch, and dinner were served and the reception was held.



Figure 5. The technical sessions in Taian Hall.



Figure 3. Mount Qingcheng, one of the birthplaces of Chinese Taoism, called “Dong Tian Fu Di” (which means a wonderful mountain and happy place). It was only a walking distance from the FEM2014 hotel, and many attendees hiked over there.



Figure 6. The technical sessions in Longchi Hall.



Figure 7. Past AP-S President, Prof. Magdalena Salazar-Palma, presented her HOFEM (higher-order finite-element method) work at FEM2014.

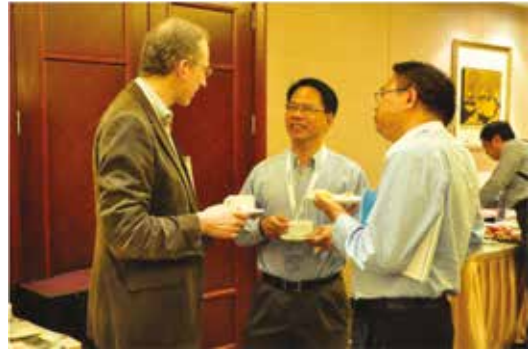

Figure 10. Attendees enjoyed the cultural exchange between the East and West during the coffee/tea breaks in the corridor outside of conference room: (l-r) Prof. Thomas Eibert, Qinghuo Liu, and Wenyan Yin.



Figure 8. Special session organizer and chair, Prof. Amir Boag, presented his work, "Moment Method and Integral Equation Solvers," at FEM2014.



Figure 11. A moment to meet old and new friends took place during the breaks (l-r): Prof. Raphael Kastner, Alona Boag, Vitaliy Lomakin, and Jun Hu (Chair of the TPC).



Figure 9. Attendees discussing recent progress in computational electromagnetics during a coffee break (l-r): Prof. Zaiping Nie (General Chair), Prof. Jianming Jin (General co-Chair), Prof. Jiming Song.



Figure 12. The FEM2014 reception dinner: General co-Chair of the FEM2014, Prof. Jianming Jin, and Chair of the TPC, Prof. Jun Hu, at the door of the Maya Café.



Figure 13. (l-r) Profs. B. Shanker, V. Lomakin, and Jun Hu, and Dr. Kezhong Zhao attending the reception dinner held at the Maya Café.



Figure 16. The closing banquet of FEM2014 at De Xing restaurant, on May 16, 2014.



Figure 14. An evening walk in Mt. Qingcheng before dinner, on May 15, 2014: (l-r) Jun Hu, Jianming Jin, Qinghuo Liu, Xinqing Sheng, and Zhen Peng.



Figure 17. The FEM2014 attendees enjoyed a famous Sichuan face-changing show at the closing banquet.



Figure 15. A committee meeting of the FEM workshop. General co-Chair, Prof. Jianming Jin, spoke about FEM2016.



Figure 18. The co-Chair of the TPC, Prof. Lijun Jiang, presented the best student paper award to three students among the ten student winners: (l-r) Wan Luo, Zi He, and Oliver Wiedenmann.

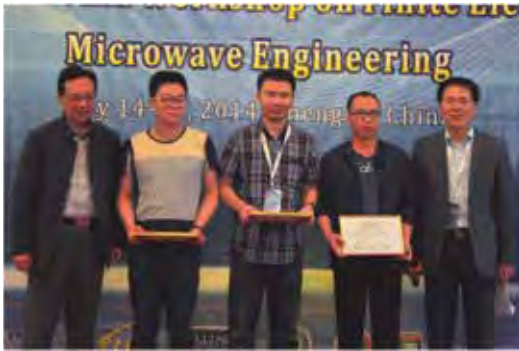

Figure 19. The co-Chair of the TPC, Prof. Xinqing Sheng, presented the best student paper award to three students among ten student winners: (l-r) L. Du, Han Guo, and Ping Li. The other four student winners were Fritz Kretzschmar, Wang Xiang Hua, Bi-Yi Wu, and Jie Zhang, presented by the co-Chair of the TPC, Prof. Rushan Chen.



Figure 20. A gathering of alumni and visiting scholars of UIUC (the first time in China): (l-r) Mei Song Tong, Amir Boag, Alona Boag, Yumao Wu, Dan Jiao, Raphael Kastner, Ruth Kastner, Su Yan, Qinghuo Liu, Ali Yilmaz, Fritz Kretzschmar, Sascha M. Schnepf, Vitaliy Lomakin, B. Shanker, Zaiping Nie, Jianming Jin, Jiming Song, Xinqing Sheng, Sheng Sun, and Lijun Jiang.



Figure 21. The members of the Chinese Computational Electromagnetics Society and international advisory members attending FEM2014: (l-r) Zhengrui Li, Guizhen Lu, David Chen, Xinqing Sheng, Xijun Yu, Rushan Chen, Junhong Wang, Jiming Song, Jianming Jin, Qinghuo Liu, Mingyao Xia, Wenyan Yin, Guoqiang Zhu, Jun Hu, and Lijun Jiang.



Figure 22. The oldest and only surviving no-dam irrigation system in the world, and a wonder in the development of Chinese science.



Figure 23. The Giant Panda Breeding Base: giant pandas are not only a Chinese national treasure, but are also beloved by people all around the world.



Figure 24. Members of the Organizing Committee of FEM2014: (l-r) TPC co-Chair Prof. Rushan Chen, TPC co-Chair Prof. Lijun Jiang, Prof. Qinghuo Liu, General co-Chair Dr. Yun Hua, General Chair Prof. Zaiping Nie, General co-Chair Prof. Jianming Jin, Vice President of the UESTC Prof. Houjun Wang, TPC Chair Prof. Jun Hu, TPC co-Chair Prof. Xinqing Sheng, Dean of the School of Electronic Engineering of the UESTC Prof. Yong Fan.



Figure 25. The General Chair of FEM2014, Prof. Zaiping Nie, presented the recognition certificates to the representatives of three commercial software companies: (l-r) FEKO, CST, and ANSYS.

We had a completely full room for discussions (Figures 7 and 8), which turned out to be extremely useful and engaging. The attendees especially enjoyed one-on-one discussions during coffee breaks (Figure 9) and social events, visiting Dujiang Dam and Panda Base.

It is a great tradition of the International FEM Workshops to provide a rich social program for the delegates. The program prepared by the FEM2014 Local Organizing Committee started with a welcome reception on the evening of May 14, 2014. Many workshop participants enjoyed delicious but spicy Sichuan food, while meeting with new and old friends.

In the afternoon of May 16, 2014, the FEM Workshop Committee held a meeting to discuss the next FEM workshop. It was decided that FEM2016 will be held in beautiful Florence, Italy.

The FEM2014 closing banquet on the evening of May 16, 2014, featured a unique Chinese experience: a Sichuan cuisine dinner with a face-changing show in Sichuan opera and folk performances, at De Xing Restaurant (Figures 16 and 17). The Vice President of UESTC, Prof. Houjun Wang, delivered a warm welcoming speech.

Following a new program introduced by FEM2012, the FEM2014 awarded ten best Student Paper Prizes, which were sponsored by Science Park of UESTC. The student awardees, coming from several countries, presented their winning papers at the workshop, and were recognized at the conference banquet (Figures 18 and 19).

Besides academic exchange and technical discussion, FEM2014 also provided an excellent opportunity for the gathering of different organizations and communities. Many attendees enjoyed meeting with friends in their community (Figures 20 and 21).

The highlight of the social program was the one-day tour after the conference. Because of the great interest, two routes were arranged for the tour on May 17, 2014. One route was to visit Dujiangyan, the oldest and only surviving no-dam irrigation system in the world (Figure 22), and Jiezi Ancient Town. The other route was to visit the Giant Panda Breeding Base to see the Chinese national treasure (Figure 23). Visitors also walked into the Wide and Narrow Lanes to feel the most local and ancient, yet international and stylish part of Chengdu city. More details on these scenes can be found at the Web site of the workshop: <http://www.fem2014.org/Nclass.asp>.

On behalf of all FEM2014 authors and participants, we would like to thank Prof. Jianming Jin, whose help and support to the FEM2014 Organizing Committee (Figure 24) were essential in all stages of the preparation and running of the workshop. Special thanks go to NSFC (National Science Foundation of China) for the great financial support. Three leading commercial software companies, ANSYS (ANSOFT), CST (Computer Simulation Technology), and EM Software & Systems SA (Pty.) Ltd. (FEKO), also provided financial support for the FEM2014, and they were recognized at the awards ceremony (Figure 25).

It was our great pleasure to be of service to the FEM and computational electromagnetics communities, to lead the organization of FEM2014, and to host so many researchers and colleagues in Mount Qingcheng. We hope to see you all and many others at our next workshop, FEM2016, to be held in Florence, Italy.

Jun Hu
Chair of the TPC of the FEM2014
University of Electronic Science and Technology of China
E-mail: hujun_uestc@126.com; hujun@uestc.edu.cn

Nie Zaiping
General Chair of the FEM2014
University of Electronic Science and Technology of China

Part II

Proceedings of the 13th Workshop

WELCOME TO FEM 2016

The 13th edition of the International Workshop on Finite Elements for Microwave Engineering takes place in Florence, Italy, 16–18 May 2016, coming back were all initiated.

The 2016 workshop attracted nearly 100 papers from all over the world, 70 of which were selected for presentation in 10 thematic sessions, plus a Plenary Session with invited lectures. Sessions are, with the pages at which contributes are published in this book:

Plenary Session	95
Multi-physics FEM techniques in the simulation of semiconductor devices	101
FEM in Italy (in two parts)	109
Acceleration/Preconditioning techniques for large problems	123
Integral equation / BEM methods	129
Advanced FEM and Hybrid Techniques (in two parts)	135
Parallel Computation on Multi- and Many-Core Computers	147
Optimization Techniques and Parameter Space Sweep	153
FEM Applications	159
Domain Decomposition and Non-Linear FEM	167
FEM Theory	173

Speakers are among the most relevant researchers in Finite Elements and come both from Academia and Industry, testifying the importance of the Workshop, which conjugates cutting edge research and practical implementation in production environment.

The Workshop itself takes place at the heart of Florence, and a few words on its sites are due. The plenary talks take place in the “Aula Magna” of the Rectorate, a monumental hall decorated in the style typical of the few years (1865-1871) in which Florence was capital city of Italy. The “Aula Magna” is at the first floor and can be reached climbing a monumental sandstone staircase of an exquisite neoclassical style. The Rectorate itself is in a building committed around 1430 by Niccolò da Uzzano who financed the construction of a College, on a project devised by Lorenzo di Bicci, and then leaving at his death in 1431 a hefty sum for the next stages of work. The building never become a College and had, over time, different destinations. Used by the friars of San Marco, later by the monks of San Giovanni de’ Cavalieri; still later the Republic made it a hospice for the poor. During the Grand Duchy period, lions, symbol of the city, were kept there. Then the lions were replaced by horses and the building become the Grand Ducal stables in 1777



Fig. 1: The “Aula Magna” (left) and the building (right) of the Rectorate, in S. Marco square in Florence.

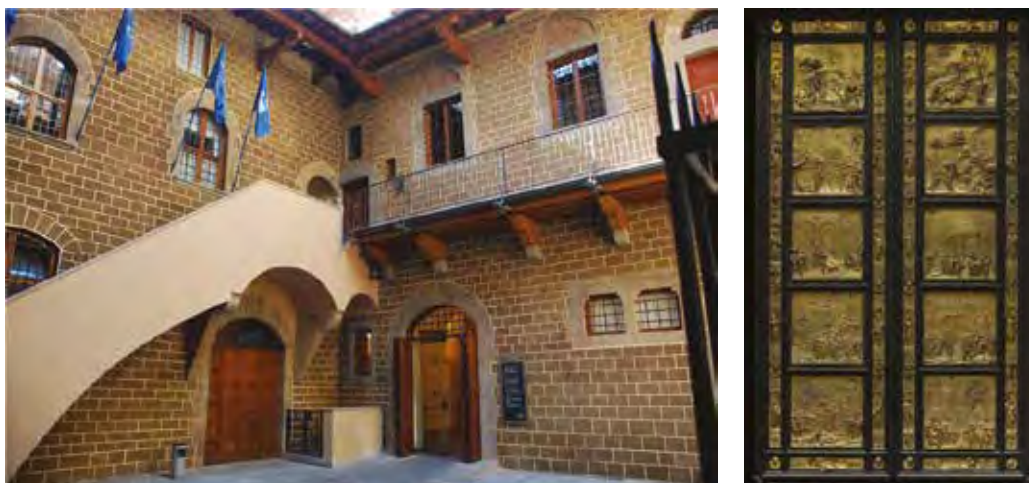

Fig. 2: The “Centro Arte e Cultura” (left) yard and the “Porte del Paradiso” of the Baptistery (right) just in front of the conference center in Florence.

and subsequently partly occupied by a squadron of the Lancers Regiment of Florence. In 1862 the complex was sold to the military administration for the quartering of two squadrons of cavalry. In 1865, having been chosen as the capital of Italy Florence, the building temporarily accommodated two General Directorates of the Ministry of War. In 1872, an agreement between the Kingdom of Italy and the Institute for Higher Studies Practical and Specialization, which would later become the University of Florence, ceded to the latter the entire complex (Fig. 1).

The Technical sessions will take place in an ancient and prestigious building, once the seat of the “Opera di San Giovanni”, exhibiting a rough stone facade and a fifteenth-century portal surmounted by a lunette and a courtyard which, although remodeled, has preserved the fifteenth century characteristics, there is a multipurpose center conceived to host conventions, conferences, training and preparatory activities for the visits of the monumental complex. Just in front of the conference center there is the Baptistery with its renown “Porta del Paradiso” [Heaven’s Gate], its eastern gate. This is the main door, located in front of the Cathedral of Santa Maria del Fiore. Made by the goldsmith and sculptor Lorenzo Ghiberti between 1425 and 1452 (with an important collaboration of his son Vittore), it is his masterpiece, and one of the most famous works of the Florentine Renaissance. Completely in gold plated bronze, was nicknamed “Paradise” by Michelangelo Buonarroti. Damaged during the flood in Florence, the original panels, after being subjected to a 27 years long restoration, are now visible in the nearby Museo dell’Opera del Duomo (the ones in the photo). Copies are mounted on the baptistery door.

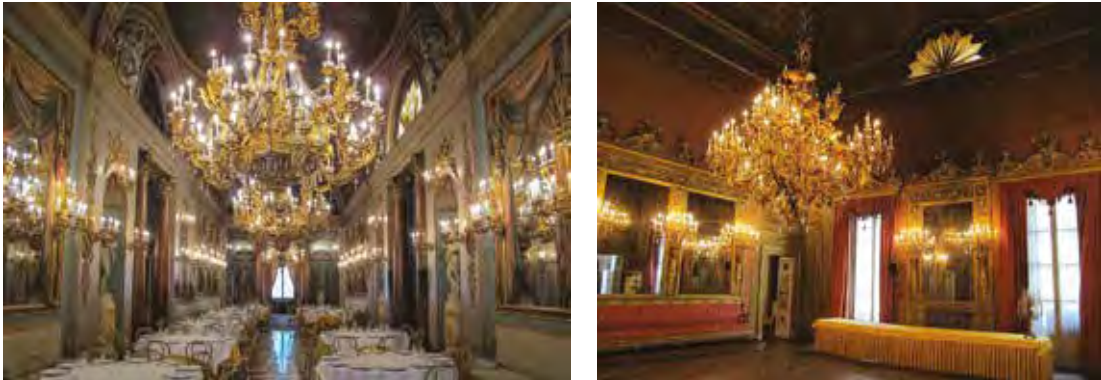

Fig. 3: Two of the magnificent rooms of “Palazzo Borghese” in Florence.

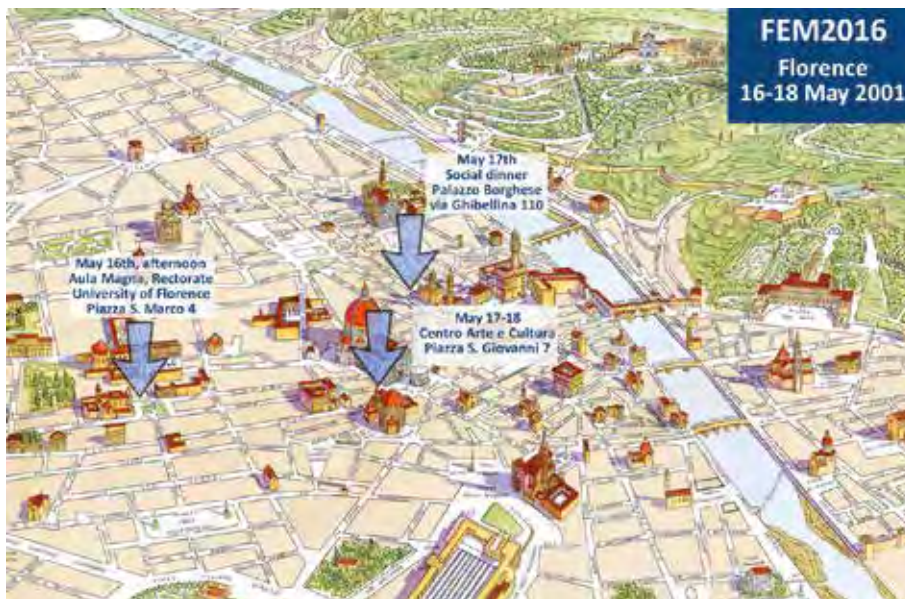

Fig. 4: Workshop places on Florence map.

Social dinner will take place in the “Palazzo Borghese” in Florence, Via Ghibellina 110 and one of the most important buildings in the neoclassical period in the city, occupying an entire block in Via dei Pandolfini, between Via delle Seggiole and Via de’ Giraldi. In this site had their homes several medieval families, including the Villani, the Portinari and the Covoni. In the thirteenth century it was bought by Salviati, that only in 1437, undertook a series of grandiose work of unification, enlargement and modernization. Architect Michelozzo created a magnificent building with a large open loggia, much admired at the time. At the end of the eighteenth century the Salviati family died out with Anna Maria Salviati, who was married to the Roman Prince Marcantonio Borghese, 5th Prince of Sulmona, the famous family from Siena. The son of the noble couple, Camillo Borghese, whose coat of arms stands on the facade, was married, albeit for a short period of time, to Napoleon’s sister, Pauline Bonaparte, with whom he lived sporadically in the city.

PLENARY SESSION

SESSION: S0
PLENARY SESSION

Finite Elements in Microwave Engineering: 1968 to 1992

Jon P. Webb

Hybrid Finite Element Methods from 1990 to 2005

John L. Volakis

Finite Elements in Microwave Engineering: 1968 to 1992

Jon P. Webb

In June 1968, at the URSI conference in Stresa, Italy, P. P. Silvester presented a paper that explained how to find the modes of empty waveguides by the finite element method (FEM). This was the earliest example of the application of FEM to an electromagnetic wave problem.

Throughout the 1970s work on waveguide modes continued, but in addition a few papers explored the use of FEM for simple radiation and scattering problems. For most of the decade work was confined to 2D elements, mainly triangles. Developments included a coupled Ez-Hz method for inhomogeneous waveguides, and axisymmetric formulations for scattering from bodies of revolution.

However, towards the end of the decade the power of computers had advanced to the point that 3D work could begin. In July 1978, ten years after Silvester's presentation on triangular elements, R. L. Ferrari and G. L. Maile published a short paper describing the application of tetrahedral elements to scattering by 3D obstacles in waveguides. The approach taken was to solve for the full, three-component electric or magnetic field, interpolating each Cartesian component as if it were a scalar. It was node-based interpolation: the element had 4 nodes, each with 3 components.

During the 80s work on 3D continued, but there were two obstacles to progress. One was the speed of computing, which made experimentation with all but the simplest 3D geometries very difficult. Naturally, this steadily improved. The other obstacle was the node-based formulation. When people started to apply it to eigenvalue problems, both in 2D (for waveguide modes again) or in 3D (for cavity resonance), they found the computed spectrum polluted with a large number of spurious, non-physical modes. It became apparent that these could also affect deterministic solutions (e.g., scattering), rendering the method unreliable in that case too. Some partial remedies were proposed, notably the penalty method, but there was no complete cure.

The solution was a new type of element, actually already described by J. C. Nédélec in 1980 in a paper in *Numerische Mathematik*. However, there was no obvious connection between this paper and the problem of spurious modes and Nédélec's work went unnoticed by the microwave FEM community until the end of the decade. In 1984 M. Hano described a 2D, rectangular element for finding waveguide modes with vector E or H, in which mixed-order, edge-based interpolation was used (though he did not call it that) and no spurious modes appeared. Four years later C. W. Crowley, P. P. Silvester and H. Hurwitz described a 3D, curvilinear brick element along the same lines, also able to eliminate spurious modes. In 1989, A. Bossavit and I. Mayergoyz proposed the use of tetrahedral edge elements, also called Whitney elements, for scattering. These are the lowest order of Nédélec element. Though no numerical results were given, it was asserted (correctly) that with Whitney elements, no spurious modes would occur.

In 1990 J. F. Lee published a paper in which a higher order form of the Whitney element was used to obtain the scattering parameters of a variety of realistic structures in waveguide and microstrip. It was now evident that FEM could be a powerful tool for microwave engineers. In May 1992, following an idea of P. P. Silvester, the first of what were to become the International Workshops on Finite Elements for Microwave Engineering was held in San Miniato, Italy.

Jon P. Webb (*Department of Electrical and Computer Engineering, McGill University, 3480 University Street, Montreal, QC, H3A 0E9, Canada, jon.webb@mcgill.ca*)



Jon P. Webb (M'83) received a Ph.D. from Cambridge University, England, in 1981. Since 1982 he has been professor in the Department of Electrical and Computer Engineering at McGill University, Montreal, Canada. His area of research is computer methods in electromagnetics, especially the application of the finite element method.

Hybrid Finite Element Methods from 1990 to 2005

John L. Volakis

Looking at research activity in the late 1980s and very early 1990s, there is little indication that the finite element (FEM) and its hybrid versions, such as the finite element boundary integral (FE-BI) methods would become the workhorse numerical analysis technique of today. In fact, the Method of Moments (Rao-Wilton-Glisson, 1982) and Greens functions for multilayer media were well regarded as the methods of choice in the late 1980s. Also, commercial packages in the early 1990s for printed circuits and antennas were based on the solution of integral equation methods. By mid- and late-1980s there were also well established radiation and scattering packages for complex geometries using high frequency methods, such as the geometrical theory of diffraction (GTD) and physical theory of diffraction (PTD). The latter were very fast and could accommodate arbitrary geometries. But high frequency methods suffered from lack of computing accuracy due to inherent asymptotic approximations. Also, there were necessary approximations in geometry rendering. Further, and most critically, material modeling was difficult to incorporate in asymptotic methods. On the other hand, the moment method was rigorous and finite element tessellations allowed for geometrical accuracy and material modeling. However, the moment method suffered from $O(N^3)$ time requirements for their matrix solution, often referred to as the curse of dimensionality.

As noted by Prof. J.P. Webb in the previous talk, the FEM had been used since the 1970s for waveguide analysis by Cendes and Silvester (1969, 1970), Webb, Maile and Ferrari (1983), and by Koshiba et.al. (1985). Absorbing boundary conditions for mesh truncation were introduced in the early 1980s by Bayliss et.al.(1980, 1982); Nedelec introduced the Whitney elements/Whitney forms for wave equation solutions in 1980; Bossavit et.al. (1982) had considered eddy-current solutions using a form of FE-BI; and Lee, Sun and Cendes (1991) presented use of vector tetrahedral elements for dielectric waveguide analysis.

However, as was the case with FEM in Civil Engineering, M.J. Turner introduced it in the 1950s, but was popularized by Argyris, Clough, Martin and Zienkiewicz in the 1960s. A critical role in the popular use of FEM for structural engineering was extensive use of the computer and above all the pursuit of killer applications. Indeed, the need for a killer app is the case for the popularization of commercial products.

In the early 1980s, this author has fortune to work in the aerospace industry and to observe the application needs and requirements, particularly the need to model inhomogeneous materials for large radiation and scattering problems. At the time, the need for high accuracy did not allow for 3D FEM application using Absorbing Boundary Conditions, and computing speeds precluded use of the FE-BI for open boundary problems as is the case with radiation and scattering.

In the mid-1980s, this author and his students at the University of Michigan (Peters and Barkeshli) were using the conjugate gradient-FFT method for large scale scattering. The impressive speed of this method to solve large matrices, and its $O(N)$ memory requirement led to the popular application of the FE-BI method by Jin and Volakis (1990, 1991) for radiation and scattering problems. These problems were the needed killer applications as they allowed for finite array analysis and for scattering by complex airframe appendages. Validation of the FE-BIs success will be done by several of my other Michigan students and post-docs, including Collins, Kempel, Chatterjee, Andersen, Ross, Anastassiou, Eibert, Tayfun, Sertel, Bindiganavale (now Navale), Gong, Kindt, and several others. Their papers considered more complex problems in radiation and scattering, and included developmental components for robust application and solution of FE-BI matrices. Acceptance of ABCs for mesh truncation will also follow. Indeed, by 1995 the FEM and its hybrid methods will be established as mainstream approaches, and popular commercial packages will quickly follow. In the opinion of this author, his overview presentation in the 1996 URSI Assembly in Kyoto, Japan, is the best indication that FEM and its hybrid were well accepted. The latter presentation was attended by as many as 150 people in a packed

room.

Edge-based higher order basis functions will be used extensively in the late 1990s and applications to arrays and frequency selective surfaces (with many dielectric layers) will make impressive leaps forward. In the mid-1990s, the Perfectly Matching Layer (Berenger, 1994) will also provide more options for FEM mesh truncation. With the initial successes of FEM, U.S. government funding will make a major difference after 1995, particularly in integrating the FE-BI with the Fast Multiple Method (Rokhlin, 1990; Song & Chew, 1994) and the Adaptive Integral Method (Blezynski, et.al., 1996; Anastassiou, et.al. 1998). The latter combined speed and robustness in terms of material modeling, complete geometrical definition via CAD, and large scale problem solutions. Domain Decomposition Methods (DDM) will be introduced into the early 2000s (Kindt, et.al.) and the more recent DDM formulations (Zhao, et.al., 2005; Vouvakis et.al. 2006) and Discontinuous Galerkin methods (Peng and Lee, 2013) have brought the FE-BI methods from the mainframe computers down to the desktop and laptop computers. Multigrid methods (Zhu and Cangellaris, 2006) provided more options for preconditioning. In the early 2000s the time-domain FEM application to radiation and scattering will be also introduced (Jiao, Ergin, Shanker, Michielssen, and Jin, 2002). However, the unstructured grid advantages of FEM for time domain problems were already known much earlier (Lee, Lee and Cangellaris, 1997).

This paper will trace some of challenges and key developments of the FEM and its hybrid versions from 1990 to 2015.

John L. Volakis (*ElectroScience Laboratory, Electrical and Computer Engineering Dept. The Ohio State University 1320 Kinnear Rd. Columbus, Ohio 43212*)



John L. Volakis (S77, M82, SM89, F96) was born on May 13, 1956, in Chios, Greece. He received the B.E. degree (summa cum laude) from Youngstown State University, Youngstown, OH, USA, in 1978, and the M.Sc. and Ph.D. degrees from The Ohio State University, Columbus, OH, USA, in 1979 and 1982, respectively. He began his career at Rockwell International (1982-84), now Boeing. In 1984, he was appointed an Assistant Professor at The University of Michigan, Ann Arbor, MI, USA, becoming a Full Professor in 1994. He also served as the Director of the Radiation Laboratory from 1998 to 2000. Since January 2003, he has been the Roy and Lois Chope Chair Professor of Engineering at The Ohio State University, Columbus, OH, USA, and serves as the Director of the ElectroScience Laboratory. Over the years, he carried out research in antennas, wireless communications and propagation, computational methods, electromagnetic compatibility and interference, design optimization, RF materials, multi-physics engineering, millimeter waves, terahertz and medical sensing. His publications include eight books, 350 journal papers, nearly 650 conference papers, and 23 book chapters. Among his coauthored books are *Approximate Boundary Conditions in Electromagnetics* (IET, 1995), *Finite Element Methods for Electromagnetics* (Wiley/IEEE Press, 1998; 4th ed.), *Antenna Engineering Handbook* (McGraw-Hill, 2007), *Small Antennas* (McGraw-Hill, 2010), and *Integral Equation Methods for Electromagnetics* (IET, 2011). He has graduated/mentored over 80 doctoral students/post-docs with 26 of them receiving best paper awards at conferences. Dr. Volakis is a Fellow of ACES. He has served as the 2004 President of the IEEE Antennas and Propagation Society (2004), Vice Chair of USNC/URSI Commission B, twice the general Chair of the IEEE Antennas and Propagation Symposium, IEEE APS Distinguished Lecturer, IEEE APS Fellows Committee Chair, IEEE-wide Fellows committee member and associate editor of several journals. He is listed by ISI among the top 250 most referenced authors (2004). He was the recipient of The University of Michigan College of Engineering Research Excellence Award (1993), the Scott Award from The Ohio State University College of Engineering for Outstanding Academic Achievement (2011), the IEEE AP Society C-T. Tai Teaching Excellence Award (2011), the IEEE Henning Mentoring Award (2013), and the IEEE AP Distinguished Achievement Award (2014).

TECHNICAL SESSIONS

SESSION: S1

MULTI-PHYSICS FEM TECHNIQUES IN THE SIMULATION OF SEMICONDUCTOR DEVICES

Organized by: Giovanni Ghione

Finite-Element NEGF Analysis of Optoelectronic Devices

X. Zhou, F. Bertazzi, M. Goano, G. Ghione, E. Bellotti, F. Dolcini, F. Rossi

Numerical FEM Techniques for the Sensitivity Parametric Analysis in Electro-Thermal Physics-Based Semiconductor Device Models

F. Bonani, S. Donati Guerrieri, G. Ghione

Parallel Deterministic Solution of the Boltzmann Transport Equation for Semiconductors

K. Rupp, A. Morhammer, T. Grasser, A. Inge

Electrothermal Simulation of Wide-Area Power Semiconductor Devices During Out-of-SOA Events

A. Irace

A 3D Finite Element Framework for Comprehensive Multi-Physics Simulation of Semiconductor Devices

R. Sacco, A.G. Mauri

Multi-physics Simulations in MEMS

A. Corigliano, A. Ghisi, S. Mariani

Finite-Element NEGF Analysis of Optoelectronic Devices

Xiangyu Zhou, Francesco Bertazzi*, Michele Goano, Giovanni Ghione, Enrico Bellotti, Fabrizio Dolcini, Fausto Rossi

Finite-element (FE) methods have been rarely employed in nonequilibrium Green's functions (NEGF) models of quantum carrier transport. The potential of FE techniques in the discretization of Dysons equations is nearly unexplored, a notable exception being (S. Steiger, *Modelling Nano-LEDs*, PhD Thesis, 2009, ETH Zürich). There are actually numerical difficulties in the use of FE in the NEGF context; for example, a FE basis leads to non-diagonal terms in the self-energies, even if the corresponding interactions are local in space. The determination of the full GF would provide information on propagation and correlations between any two points of the device and thus would include all nonlocal phenomena. In order to reduce the computational burden, a limited number of non-zero off-diagonal GF elements is considered; this approximation allows the use of efficient recursive techniques to compute selected elements of the inverse matrix (the GF) needed for the evaluation of energy- and spectrally-resolved single-particle quantities. Although carrier-phonon scattering mechanisms are undeniably nonlocal, their local approximation seems to be the only viable approach to 3D NEGF simulations. Factor in that the derivation of self-energies from the perturbation expansion of the statistical average defining the interacting NEGF is more involved when a nonorthogonal FE basis is employed. Factor in, too, that multiband envelope function models widely employed in the design of optoelectronic devices may lead to spurious, unphysical solutions playing havoc in subband dispersions, especially in FE implementations.

Notwithstanding the difficulties above, there are very good reasons to use FEs in NEGF in the simulation of optoelectronic devices. Besides the geometrical flexibility afforded by the FE method, what makes the extra complication worthwhile is the rigorous treatment of material discontinuities in Schrödinger(-like) problems, where other approaches have to rely

on special boundary conditions to ensure current continuity. Efficient algorithms exploiting advanced matrix partitioning strategies for the GF calculation, such as FIND (S. Li et al., "Computing entries of the inverse of a sparse matrix using the FIND algorithm", *J. Comput. Phys.*, **227**, 2008, pp. 9408–9427), based on the nested dissection, and SelInv (L. Lin et al., "Fast algorithm for extracting the diagonal of the inverse matrix with application to the electronic structure analysis of metallic systems", *Commun. Math. Sci.*, **7**, 2009, pp. 755–777), based on the selected inversion, may in part be the key to FE implementations. More importantly, FE approaches do not lead to off-diagonal penalties when carrier-photon interactions are included, as local approximations are not applicable in this case, which also means that a multiscale description of light-emitters (-detectors) should combine an NEGF treatment of the active region with an approximate description of the "leads". Concerning the numerical stability, we observe that the remedies proposed to eliminate spurious solutions in FD approaches have not yet found wide acceptance, the issue also being related to operator ordering and the choice of the band parameters. In the present talk, we present a rigorous FE procedure to determine operator ordering and band parameters from nonlocal empirical pseudopotential calculations. The proposed approach leads to well-posed, numerically stable envelope equations that accurately reproduce full-Brillouin-zone subband dispersions of quantum systems (X. Zhou et al., "Deriving k·p parameters from full-Brillouin-zone descriptions: A finite-element envelope function model for quantum-confined wurtzite nanostructures", *J. Appl. Phys.*, **116**, 2014, 033709]. Examples will be provided in the context of the NEGF simulation of optoelectronic devices.

Xiangyu Zhou, Francesco Bertazzi, Michele Goano, Giovanni Ghione (*Department of Electronics and Telecommunications, Politecnico di Torino, Corso Duca degli Abruzzi 24, 10129 Torino, ITALY, francesco.bertazzi@polito.it*)

Francesco Bertazzi, Michele Goano (*IEIIT-CNR, Politecnico di Torino*)

Enrico Bellotti (*Department of Electrical and Computer Engineering, Boston University, 8 Saint Marys Street, Boston, MA 02215, USA*)

Fabrizio Dolcini, Fausto Rossi (*Department of Applied Science and Technology, Politecnico di Torino*)

Numerical FEM Techniques for the Sensitivity Parametric Analysis in Electro-thermal Physics-Based Semiconductor Device Models

Fabrizio Bonani, Simona Donati Guerrieri, Giovanni Ghione

We present a general approach to evaluate the sensitivity and variability of the electrical performances and operating temperature of a semiconductor device to a random variation of technological parameters exploiting a PDE-based physical model, such as the drift-diffusion one coupled to the heat diffusion (Fourier) equation. Consider the intrinsic device embedded in an equivalent thermal network, see Fig. 1. Self-heating is accounted for by a concurrent solution of the coupled intrinsic device electrical and thermal models, synthetically written as:

$$\mathbf{F}(\mathbf{x}, \mathbf{v}_c; \mathbf{T}_c; \sigma) = \mathbf{D}\dot{\mathbf{x}}; \quad \mathbf{x} = \{\mathbf{n}, \mathbf{p}, \varphi, \mathbf{T}\} \quad (1)$$

where \mathbf{x} is the vector of the unknowns (carrier concentrations, potential and lattice temperature) discretized over the device mesh through a FEM approach, \mathbf{F}, \mathbf{D} is the set of discretized equations (e.g. carrier continuity, Poisson and Fourier); \mathbf{v}_c and \mathbf{T}_c are the voltages and temperatures on the electrical contacts and/or thermodes. The equations depend on a technological parameter σ that undergoes deterministic or statistical variations $\Delta\sigma$. Such variability can be described by linearizing the equations with fixed temperature and voltage at the contacts/thermodes:

$$\begin{aligned} \mathbf{J}(\mathbf{x}_S, \sigma_0, \mathbf{v}_c, \mathbf{T}_c) \Delta \mathbf{x} + \left. \frac{\partial \mathbf{F}}{\partial \sigma} \right|_{\mathbf{x}_S, \sigma_0, \mathbf{v}_c, \mathbf{T}_c} \Delta \sigma + \\ + \left. \frac{\partial \mathbf{F}}{\partial \mathbf{v}_c} \right|_{\mathbf{x}_S, \sigma_0, \mathbf{v}_c, \mathbf{T}_c} \Delta \mathbf{v}_c + \\ + \left. \frac{\partial \mathbf{F}}{\partial \mathbf{T}_c} \right|_{\mathbf{x}_S, \sigma_0, \mathbf{v}_c, \mathbf{T}_c} \Delta \mathbf{T}_c = \mathbf{D} \Delta \dot{\mathbf{x}} \quad (2) \end{aligned}$$

Observation variables resulting from the parameter variation will be chosen to be: 1) **the**

electrical currents at the electrodes: their variation $\Delta \mathbf{I}_c$ will be linked to $\Delta \sigma$ by means of *Green's Functions* (GF) of the above system; 2) **the thermal fluxes on the thermodes:** their variation $\Delta \mathbf{S}_c$ is also found by appropriate GFs. Finally, the device allows for a linearized representation through an equivalent *device electrothermal admittance matrix* \mathbf{Y}_{eq} , which can be calculated by an efficient GF approach simultaneously with the quantities in 1) and 2). The validation of the GF sensitivity approach is made through comparison with the direct device simulation with varying σ parameters. The resulting small-signal electro-thermal circuit, see of Fig. 1, right, allows for the parametric variability analysis and/or optimization of an electrical or electrothermal device embedded in a realistic thermal/electrical environment, e.g. with Z_{TH} calculated off-line and coupled to the device at the circuit level, hence saving simulation time.

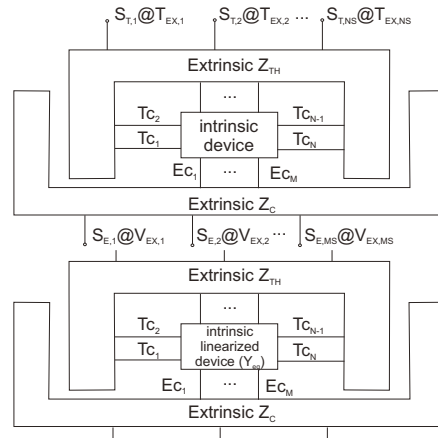

Fig. 1: Up) Intrinsic device representation in terms of N thermodes ($T_{c1} \dots T_{cN}$), M electrodes ($E_{c1} \dots E_{cM}$) coupled to NS extrinsic heat sinks/ MS voltage sources at fixed temperature/voltage by means of thermal and electrical impedances. Down) Linearized representation for parametric variations.

Fabrizio Bonani, Simona Donati Guerrieri, Giovanni Ghione (*Dipartimento di Elettronica e Telecomunicazioni, Politecnico di Torino, Corso Duca degli Abruzzi 24, 10129 Torino, Italy, {fabrizio.bonani, simona.donati, giovanni.ghione}@polito.it*)

Parallel Deterministic Solution of the Boltzmann Transport Equation for Semiconductors

Karl Rupp*, A. Morhammer, Tibor Grasser, Ansgar Jüngel

Clock frequencies and hence single-threaded processing power of modern processors have saturated because of power constraints. As a consequence, the overall processing power in modern processors mostly stems from parallelization and vectorization. However, parallel processors can only be used efficiently with suitable parallel algorithms. Unfortunately, the design and implementation of such parallel algorithms is often difficult and requires problem-specific knowledge for best performance. We present results of a successful parallelization of a semiconductor device simulator based on deterministic solutions of the Boltzmann transport equation.

Our results are obtained for the method of spherical harmonics expansions for solving the Boltzmann transport equation deterministically. The flux-conserving discretization scheme leads to large systems of sparsely coupled linear equations, which are solved with iterative solvers such as the generalized minimum residual method. As shown by Jungemann et al. (“Stable Discretization of the Boltzmann Equation based on Spherical Harmonics, Box Integration, and a Maximum Entropy Dissipation Principle”, *J. Appl. Phys.*, **100**(2), 2006), good preconditioners are required for the spherical harmonics expansion method to ensure convergence of iterative solvers. Conventionally employed preconditioners from the family of incomplete LU factorizations are, however, purely sequential, hence using only a fraction of the computing power available in modern processors. We derived a domain-specific block-preconditioner and demonstrated up to ten-fold performance gains on a single workstation in earlier work (On the Feasibility of Spherical Harmonics Expansions of the Boltzmann Transport Equation for Three-Dimensional Device Geometries”, *IEDM Techn. Digest*, 2011). In this work we refine these ideas based on a parallel variant of incomplete LU factorization preconditioners proposed by Chow and Patel (“Fine-Grained

Parallel Incomplete LU Factorization”, *SIAM J. Sci. Comp.*, **37**(2), 2015). Our results show that our proposed preconditioner is executed efficiently on current multi-core central processing units as well many-core architectures such as graphics processing units. Coupling the results of our earlier work with the results in this work, we sketch a domain-specific preconditioner suitable for compute clusters with hundreds of processors and thousands of cores.

Karl Rupp, A. Morhammer, Tibor Grasser (Institute for Microelectronics, TU Wien, Gußhausstraße 27-29/E360, A-1040 Wien, Austria)

Ansgar Jüngel (Institute for Analysis and Scientific Computing, TU Wien, Wiedner Hauptstraße 8-10/E101, A-1040 Wien, Austria)

Electrothermal Simulation of Wide-Area Power Semiconductor Devices During Out-of-SOA Events

Andrea Irace

The electro-thermal behaviour of power semiconductor devices is influenced not only by the temperature dependence of electrical quantities such as mobility and threshold voltages but also by the geometry of the device and by the mutual interaction of the many cell that are needed to give the device its capability of controlling very high currents. For this reason physical TCAD simulation of a limited number of cells rarely give quantitative information about the electro-thermal stresses. In this work we present the state-of-art of different simulation strategies apt to understand, from a 3D point of view and over the entire device area, the onset and evolution of critical phenomena such as current filamentation and hopping during short-circuit and avalanche operation of the device.

To this purpose we introduce Thermal Feedback Blocks. Thermal Feedback Blocks (TFBs) are a viable alternative to perform thermal and electrothermal (ET) simulations of electronics systems with very fast-switching inputs, for which the coupling of a finite-element method (FEM) thermal solver with a physics-based or a circuit simulator cannot be

used. The optimized TFBs is obtained through a model order reduction (MOR) process.

The mesh obtained from commercial (e.g., COMSOL) or open-source tools, material properties, and boundary conditions are to be provided as input. The fully automatic MOR (Codecasa L., *IEEE Trans. Compon. Packag. Technol.*, vol. **30**, no. 4, Dec. 2007) relies on multi-point moment matching (MPMM): the model precision is user-defined by specifying a single error parameter. The TFB topology for n heat sources (HSs) requires a small number \hat{n} of RC pairs. This approach benefits from the following advantages: (1) it is extremely fast since it does not require costly transient thermal simulations in pre-processing, (2) can be used for power devices and circuits, including modules and packages, with arbitrary geometries, allowing reconstructing the temperature field and heat flow over all the points of mesh, and at any time instant, in a post-processing step. This approach can be used to simulate any kind of semiconductor device, provided that a suitable SPICE model is available to model the temperature-dependent electrical behavior of the device under investigation. As examples, short circuit to the Power Supply or High Current avalanche operation can be simulated taking accurately into account the thermal interaction between a non-linear heat source and the module where the latter is embedded.

Andrea Irace (*Dipartimento di Ingegneria Elettrica e delle Tecnologie dell'Informazione, Via Claudio, 21, Universit degli Studi di Napoli Federico II, email: andrea.irace@unina.it*)

A 3D Finite Element Framework for Comprehensive Multi-Physics Simulation of Semiconductor Devices

Riccardo Sacco, Aurelio Giancarlo Mauri

Two concomitant factors play a significant role in the novel challenges posed by the technologies of semiconductor industry of the future five years. The continuous increase of device length scaling makes three-dimensional (3D)

modeling and numerical simulation play a critical role in the prediction of the electrical performance of the system under investigation (P. Cogež, M. Graef, B. Huizing, R. Mahnkopf, H. Ishiuchi, N. Ikumi, S. Choi, J. H. Choi, C. H. Diaz, Y. C. See, P. Gargini, T. Kingscott, and I. Steff. “The International Technology Roadmap for Semiconductors: 2013”. Technical report, Jointly sponsored by ESIA, JEITA, KSIA, TSIA and SIA, 2013.). Aggressive scaling has also the effect to push contemporary research towards the use of innovative materials where new physical phenomena occur, as is the case of resistive memories (H.-S. Wong, S. Raoux, S. Kim, J. Liang, J.P. Reinenberg, B.Rajendran, M. Asheghi, and K.E. Goodson. Phase change memory. *Proceeding of the IEEE*, 98(12):2201–2227, 2010, I., Valov, R. Waser, J.R. Jamenson, and M.N. Kozicki. Electrochemical metallization memories-fundamentals, applications, prospects. *Nanotechnology*, 22:1–22, 2011.)

In these technologies the active material where transport, diffusion and reaction processes occur is no longer homogeneous but often displays a markedly heterogeneous structure (e.g., in advanced logic devices) and the main physical material properties are not constant but also evolve in time due to the extreme working conditions (i.e., because of high electric and/or thermal fields). A multidisciplinary approach is the key to describe the basic functionality of heterogeneous devices in the correct physical framework. Theoretical elements of semiconductor device physics, chemical, thermal and mechanical properties, must be included and coupled to allow self-consistent calculations that account for the mutual interplay among the various phenomena occurring in the same device. This strong requirement reflects into a similar constraint in the numerical treatment of the problem because standard simulation suites are no longer usable but they need to be integrated and in some cases completely developed from scratch. In this communication we aim to illustrate the general-purpose mathematical and numerical framework that we have recently developed, in which different physical contributions to the simulation can be effectively incorporated and mutually coupled to reach the desired self-consistency

and model accuracy. (G. Novielli, A. Ghetti, E. Varesi, A. Mauri, and R. Sacco. Atomic migration in phase change materials. In *Electron Devices Meeting (IEDM), 2013 IEEE International*, pages 22.3.1–22.3.4, Dec 2013.) (A. Mauri, R. Sacco, and M. Verri. Electrothermo-chemical computational models for 3D heterogeneous semiconductor device simulation. *Applied Mathematical Modelling*, 2014. <http://dx.doi.org/10.1016/j.apm.2014.12.008>) (A. Benvenuti, A. Ghetti, A. Mauri, H. Liu, and C. Mouli. Current and future prospects of non-volatile memory modeling. In *Electron Devices Meeting (SISPAD), 2014 IEEE International*, pages 249–252, Sept 2014.)

The model consists of a system of nonlinearly coupled time-dependent diffusion-reaction partial differential equations (PDEs) with convection terms describing the principal electrical, thermal, chemical and fluid-mechanical phenomena that determine the macroscopic electrical response of the device under the action of externally applied electrical, thermal, chemical and mechanical forces. The system is supplied with initial, boundary and interface conditions that account for the interaction occurring among the various regions of the device with the surrounding environment. The numerical approximation is conducted in two distinct steps. In the first step, temporal semi-discretization is carried out with the Backward Euler Method using a non-uniform time stepping. In the second step, a fixed-point iteration of Gummel type is adopted for system decoupling. (J.W. Jerome. *Analysis of Charge Transport*. Springer-Verlag, Berlin Heidelberg, 1996.)

This leads to solving a sequence of linearized advection-diffusion-reaction equations of smaller size that are numerically treated using the Galerkin Finite Element Method (GFEM) on an unstructured tetrahedral partition of the computational domain. (A. Quarteroni and A. Valli. *Numerical Approximation of Partial Differential Equations*. Springer, 2008.)

Specifically, for the discretization of the electro-thermo-chemical module, the exponentially fitted stabilized FE scheme proposed and studied in (E. Gatti, S. Micheletti, and

R. Sacco. A new Galerkin framework for the drift-diffusion equation in semiconductors. *East-West J. Numer. Math.*, 6(2):101–135, 1998.) (J. Xu and L. Zikatanov. A monotone finite element scheme for convection-diffusion equations. *Math. Comp.*, 68(228):1429–1446, 1999.) (C. de Falco. Quantum-Corrected Drift-Diffusion Models and Numerical Simulation of Nanoscale Semi-conductor Devices. PhD thesis, Università degli Studi di Milano, 2006.) is adopted, while for the fluid-mechanical module the unified Herrmann formulation, valid for both compressible and incompressible regimes, is discretized using the Taylor-Hood finite element pair. (T.J.R. Hughes. *The Finite Element Method, Linear Static and Dynamic Analysis*. Prentice-Hall, Englewood Cliffs, New Jersey, 1987.) (A. Quarteroni and A. Valli. *Numerical Approximation of Partial Differential Equations*. Springer, 2008.)

Special care also is devoted to a careful approximation of vector-valued quantities (electrochemical and electrothermal flux densities) based on a primal-mixed FEM (A. Mauri, A. Bortolossi, G. Novielli, and R. Sacco. 3D finite element modeling of impact ionization in industrial semiconductor device simulation (*Journal of Mathematics in Industry*, 2015. to appear) that adapts and extends to 3D the classic 1D Scharfetter-Gummel difference scheme employed in any existing simulation tools for contemporary semiconductor device analysis and design. (D.L. Scharfetter and H.K. Gummel. Large signal analysis of a silicon read diode oscillator. *IEEE Trans. Electron Devices*, pages 64–77, 1969.)

Numerical schemes, models and algorithms are implemented in a general-purpose modular numerical code based on the use of the Galerkin FEM in a fully 3D framework through shared libraries using an objected-oriented programming language (C++). A thorough illustration of the performance of the proposed computational environment is carried out in terms of physical accuracy and comparison with a commercial software. (Sentaurus Device User Guide. Synopsis Inc., 2013.) Simulated components include 3D p-n diodes, p-MOS and n-MOS transistors in the presence of severe Impact Ionization generation phenomena, as well as as heterogeneous memory devices compris-

ing conductive and dielectric regions in which conventional electron transport and charge injection from metals, thermal effects and mass transport of chemical species co-exist in a unified setting to determine the overall electric behavior of the device structure under investigation.

Riccardo Sacco, Aurelio Giancarlo Mauri (*Dipartimento di Matematica, Politecnico di Milano, Piazza Leonardo da Vinci 32, 20133 Milano, Italy, riccardo.sacco@polimi.it, aurelio.mauri@mail.polimi.it*)

More specifically, a strategy proposed by the Authors in which DD and MOR are combined in a highly efficient way will be presented and discussed with reference to the following applications related to the MEMS world: electro-mechanical coupled problems for electrostatically actuated mechanical resonators, thermo-mechanical coupled problems in mechanical resonators, fracture initiation and propagation in microsystems.

Alberto Corigliano, Aldo Ghisi, Stefano Mariani (*Department of Civil and Environmental Engineering, Politecnico di Milano, piazza L. da Vinci 32, 20133 Milano, Italy, alberto.corigliano@polimi.it, aldo.ghisi@polimi.it, stefano.mariani@polimi.it*)

Multi-Physics Simulations in MEMS

Alberto Corigliano, Aldo Ghisi, Stefano Mariani*

Micro Electro Mechanical Systems (MEMS) are devices which have recently found many applications in the consumer, automotive and biomedical engineering market. Applications and markets for MEMS are now fast expanding due to the incoming Internet of Thing (IOT); as a consequence, the study and design of MEMS is more and more demanding.

Design and reliability assessment of MEMS is more and more based on highly realistic simulations of complex multi-physics processes, in this field modelling accuracy and computing time are contrasting needs that must be suitably balanced. Many different physics are intrinsically coupled in MEMS and it is often impossible to rely only on simplified, fully decoupled simulations. The increasing popularity of MEMS, the necessity to improve their design and to reduce the time to market has forced many researchers and software companies to produce dedicated methods and codes applicable to the solution of typical multi-physics problems in MEMS like e.g. the electro-mechanical, the thermo-mechanical, the magneto-mechanical ones.

Starting from the experience of the Authors, the presentation will focus on recent trends and novelties in the field of modeling and simulation for MEMS: important issues like Domain Decomposition (DD) and Model Order Reduction (MOR) strategies will be discussed with reference to coupled and highly non-linear problems for MEMS.

SESSION: S2

FEM IN ITALY (PART 1)

Organized by: Antonio Laudani, Alessandro Toscano

Convergence Analysis of a NURBS-Based Boundary Integral Equation Solver

U. Iemma, V. Marchese

Equivalent Polynomial Quadrature for Discontinuous Fields in the Extended Finite Element Method

G. Ventura

Derivatives Computation of FEM Solution by Using RPQ Formulae

S. Coco, A. Laudani

FEM Computation of Current Density and Oersted Field in Real Spin-Torque Driven Magnetization Devices

A. Giordano, G. Finocchio, A. Laudani

Numerical Simulations of Surface Plasmon Polaritons Using FEM

G. Lo Sciuto, G. Capizzi

FEM–NN Tool for the Simulation of Vector-Hysteresis in Magnetic Device

E. Cardelli, A. Faba, A. Laudani, G.M. Lozito, F. Riganti Fulginei, A. Salvini

Convergence Analysis of a NURBS-Based Boundary Integral Equation Solver

*Umberto Iemma**, *Vincenzo Marchese*

Aim of the present paper is to analyze the convergence properties of a Boundary Integral Equation (BIE) solver based on Non Uniform Rational Basis-Splines (NURBS). NURBS are used to represent dependent and independent variables (isogeometric approach). In two dimensions, the resulting integral representation of the unknown function $\varphi(\mathbf{x})$ assumes the form

$$\varphi(\mathbf{y}) = b(\mathbf{y}) - \sum_{i=1}^N q_i \oint_{\Gamma} \frac{\partial G(u, \mathbf{y})}{\partial n} R_{i,p}(u) J(u) du \quad (1)$$

with

$$\varphi(u) = \sum_{i=1}^N R_{i,p}(u) q_i \quad (2)$$

where $u \in [0, 1]$ and the basis functions $R_{i,p}$ are written in terms of rational functions $N_{i,p}(u)$ as $R_{i,p}(u) = N_{i,p}(u)W_i / [\sum_{i=1}^n N_{i,p}(u)W_i]$. It is worth noting that the integrals in Eq. 1 extend to the whole boundary, making the partition of Γ not strictly required. The solution is obtained through the collocation method, setting $\mathbf{y}(u_k) \in \Gamma$, with $u_k \in G$, being G the set of the Greville abscissae in the NURBS parametric space. The great advantage of the present formulation is that the order p of representation of the variables can be chosen at runtime, thanks to the recursive definition of the rational functions $N_{i,p}(u)$. As a consequence, the concept of p -convergence has a slightly different meaning, being the order of representation a tunable parameter, rather than an intrinsic property of the algorithm. On the other hand, also the concept of h -convergence deserves a specific discussion. Indeed, the refinement of the collocation points distribution in the NURBS parametric space is here the only possible strategy to locally improve thereproduction of the geometry or to capture some peculiar physical behaviour. The convergence properties of the formulation are analyzed for 2D aerodynamic and acoustic applications. The results of the numerical simula-

tions reveal a remarkable rate of convergence, always higher than that expected for a polynomial representation of the same order (see Fig. 1). The method is currently being extended to three-dimensional problems by coupling the presented two-dimensional formulation with Coons patches, in order to easily reproduce complex manifolds.

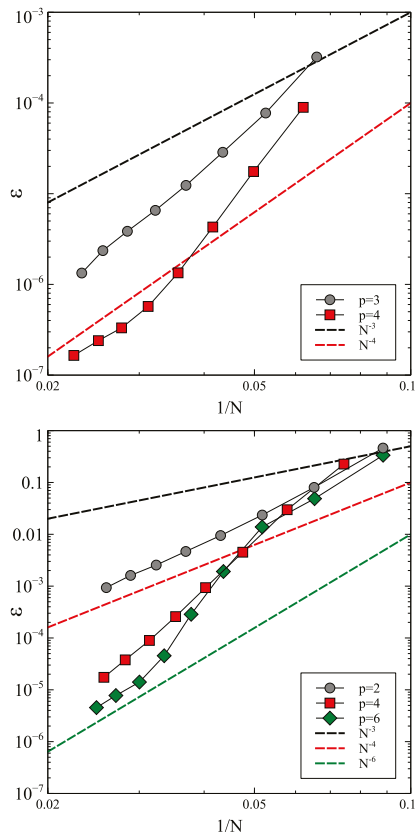

Fig. 1: Convergence rate of the error with the number of NURBS control points, N , for potential aerodynamics (left) and acoustics (right). The error ϵ is the L^2 -norm of the difference with the analytical solutions. The convergence rate of polynomial basis functions of the same order is indicated. **(left)** Laplace Equation **(right)** Helmholtz Equation.

Umberto Iemma, Vincenzo Marchese (*Department of Engineering, Roma Tre University, Via Vito Volterra 6 2, 00146 Rome, Italy, umberto.iemma@uniroma3.it, vincenzo.marchese@uniroma3.it*)

Equivalent Polynomial Quadrature for Discontinuous Fields in the Extended Finite Element Method

Giulio Ventura

The eXtended Finite Element Method (X-FEM) is a recent technique emerged in Computational Mechanics whose idea is to enrich the finite element space with additional functions that reproduce the features of the expected solution. The X-FEM is based on the concept of partition of unity enrichment, introduced in 1996 (J.M. Melenk, I.Babuška, “The partition of unity finite element method: basic theory and applications”, *Comput. Methods Appl. Mech. Engrg.*, **139**, 1996, 289–314). It was then expanded and applied to different fields by many Authors (T. Belytschko, R. Gracie, G. Ventura, “A review of extended/generalized finite element methods for material modeling”, *Model. Simul. Mater. Sci. Eng.*, **17**(4), 2009, art. no. 043001). Typical applications include fracture modeling, moving interfaces, singularities, material discontinuities, grain and phase boundaries to cite the most common.

The ability of X-FEM to include discontinuous and non-linear enrichment functions in its representation basis allows to model solution features independently of the mesh. This allows for drastic simplifications in mesh generation and also avoids the need for remeshing as discontinuities evolve. However, the addition of enrichment functions into the finite element approximation has the drawback that standard Gaussian quadrature cannot be employed for evaluating the element matrices. This problem is usually solved by defining quadrature sub-cells inside the single finite element. However, especially when 3D elements are crossed by discontinuity planes, subdivision into quadrature subcells may be quite cumbersome and time consuming. This contribution presents an innovative approach to quadrature, where discontinuous enrichment functions are mapped onto equivalent polynomials. These polynomials have the property that they yield the exact quadrature result and allow to apply standard quadrature rules for element matrices computations. The result is a substantial simplification of X-FEM implementation while improving efficiency. The derivation of this methodol-

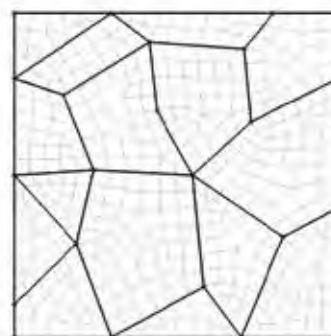
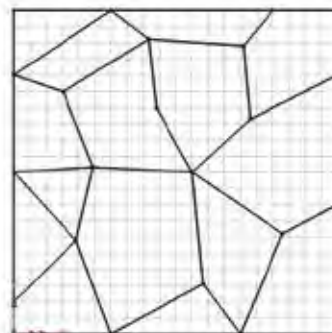

Fig. 1: Illustrative comparison of an XFEM mesh (top) to a standard FEM mesh (bottom) for grain boundaries.

ogy will be shown, as well as some illustrative examples.

Giulio Ventura (*Department of Structural, Geotechnical and Building Engineering, Politecnico di Torino, Corso Duca degli Abruzzi 24, 10129 Torino, Italy, giulio.ventura@polito.it*)

Derivatives Computation of FEM Solution by Using RPQ Formulae

Salvatore Coco*, Antonino Laudani

The computation of derivatives of 3-D finite element (FE) solutions of electromagnetic problems is usually used to evaluate several global

(energy, charge, etc.) and local electromagnetic quantities (forces, field from potential, etc.). On the other hand, the numerical computation of derivatives usually returns scarcely accurate estimates, especially when rough discretization or first-order interpolation functions are used in the solution of the problem. In the 1991, P. P. Silvester (P. P. Silvester, "Differentiation of finite element approximations to harmonic functions," *IEEE Trans. Magn.*, Sept. 1991.) proposed the use of Poisson Integrals (PI) to enhance the result accuracy, in such a way that an integral operation is performed instead to a differentiation to compute numerical derivatives. Unfortunately, the numerical evaluation of PI, performed by standard quadrature formulas, such as the Gauss-Kronrod numerical integration, may require a considerable number of quadrature points in order to reach the target accuracy above all in case of Poisson problem, which requires both a surface and a volume integral, especially in three-dimensional (3-D) problems. Different approaches base on the use of regular disposition of points on spherical domains can be also taken into account, but the computation of volume integral leads to a not negligible computational cost. In the recent past, the authors have introduced an innovative quadrature approach for PI based on the use of quadrature points belonging to regular polyhedra, reducing considerably the computational effort (S. Coco, A. Laudani, "New RPQ Formulas for the Numerical Differentiation of 3-D Finite Element Solutions of Electromagnetic Problems", *IEEE Trans. Magn.*, April 2007). This technique, named Regular Polyhedra Quadrature (RPQ) of Poisson Integrals (PI), drastically reduces computational effort still assuring accuracy of results, above all if the vertices of an icosahedron (12 vertices, see fig. 1) or a dodecahedron (20 vertices) are used as selected quadrature points. In addition, exploiting two icosahedra or dodecahedra (one inside the other), it is possible to reach a higher accuracy avoiding the volume integral. This technique, although theoretically developed for Laplace and Poisson problem, can be applied with satisfactory results to any electromagnetic problem, and its implementation in a postprocessor module is quite simple. Indeed, the tests have shown that the accuracy

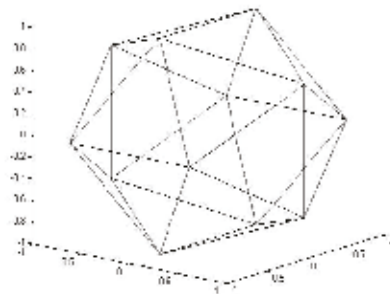

Fig. 1: An icosahedron.

of the procedure is guaranteed also for electromagnetic problems governed by Helmholtz equations. Herein, we proposed further development in order to assess the accuracy achievable. Further details will be furnished in the full version.

Salvatore Coco (*DIEEI, University of Catania, Viale A. Doria 6, 95125 Catania, Italy, coco@dieei.unict.it*)

Antonino Laudani (*Department of Engineering, Roma Tre University, Via Vito Volterra 62, 00146 Roma, Italy, alaudani@uniroma3.it*)

FEM Computation of Current Density and Oersted Field in Real Spin-Torque Driven Magnetization Devices

*Anna Giordano**, *Giovanni Finocchio*, *Antonino Laudani*

Current-driven magnetization processes are an extremely active field in magnetism. Indeed the magnetization state of a nanomagnet is influenced directly by electrical currents as demonstrated by extensive studies on the spin-transfer torque (STT) effect. This kind of magnetization dynamics is attractive for both technological aspects and fundamental physics: indeed, the current-induced magnetization dynamics differs qualitatively from the field-induced dynamics. As example, the excitation of high-frequency magnetic oscillations induced by means of DC spin-polarized currents gives the possibility of tuning the frequency of these oscillations by varying the cur-

rent intensity. Nevertheless, although the micromagnetic simulations have nowadays developed to a high level of accuracy and reliability, in some case there is a discrepancy between simulated and experimental results in the case of current-induced magnetization dynamics. This disagreement is connected with the Oersted field. Indeed, the value of the Oersted field depends sensitively on the strength of the current density and on its inhomogeneous distribution (and consequently on the geometry of the device and on the shape of the contacts). Consequently, the problem of current density distribution evaluation cannot be separated from the one of the Oersted field computation, in order to be able to take into account its effects and help the explanation of the physical behaviour for such kind of devices. The Elliptic differential problem ruling the current density distribution can be routinely solved with FEM, by specifying appropriate boundary conditions. In fact, being the boundary conditions assigned by means of current density, that is only homogeneous and inhomogeneous Neumann boundary conditions, the resulting finite element algebraic system could be ill conditioned, if an unsuitable discretization is used. Thus, the main issue is to build an accurate finite element mesh (irregular) that avoids too large and ill-conditioned matrix. The main bottleneck is related to the size of the real device, usually having a thickness of the order of tens nanometers, whereas the width and the length of the outline are both some micrometers (a sketch is shown in fig. 1). This makes the creation of the mesh a significant problem. Another important issue is the computation of the current density distribution, since this involves a derivative of the finite element solution (expressed in term of electric scalar potential) and such an operation usually generates noisy estimates. In order to overcome this problem it is possible to use efficient post-processing techniques (such as Regular Polyhedra Quadrature formula), which allow to achieve accurate results without the use of thin meshes or higher order elements. Lastly, for a more efficient computation, a finite element problem can also be defined for the Oersted field, by assuming as source the current density distribution achieved by solving the FE problem for density current distribution. In this case, a suit-

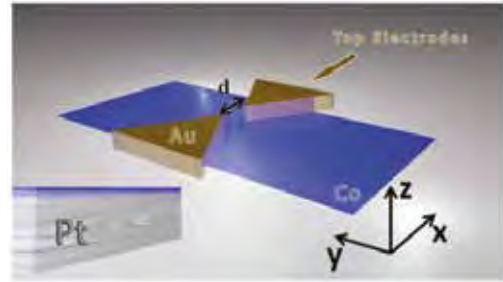

Fig. 1: Sketch of a typical micromagnetic device.

able assignment of boundary condition is necessary and usually the best choice is to consider an unbounded problem. In this way, a self-consistent problem for the magnetic field (the Oersted field) can be defined by using a hybrid FEM/BEM, or according to the so called Boundary Iteration method, based on FEM application with a fictitious domain.

Anna Giordano, Giovanni Finocchio (*Department of Mathematics and Computer Science, Physics and Earth Science, University of Messina, Viale F. Stagno d'Alcontres 31, I-98166 Messina, Italy*)

Antonino Laudani (*Department of Engineering, Roma Tre University, via V. Volterra 62, I-00146 Roma, Italy alaudani@uniroma3.it*)

Numerical Simulations of Surface Plasmon Polaritons Using FEM

Grazia Lo Sciuto, Giacomo Capizzi*

The development of nanoplasmonic has been a topic of increasing interest in recent years. Computer simulations have proved to be a very indispensable tool to obtain a better understanding of solar cells performance and to determine optimizing trends for material parameters. The recent progress has been possible as a result of advances in nanofabrication technology. Plasmonic nanoparticles are of great interest for light trapping in thin-film silicon solar cells, since metal nanoparticles can provide light-trapping performance, through excitation of charge carriers. The characteristic length

scale of the structures necessary to manipulate and generate surface plasmon polaritons (SPPs) in the visible and near-infrared region of the optical spectrum is in the nanometer regime. The basic structure of a propagating SPP is an evanescent wave, decaying exponentially in intensity normal to the interface, and oscillating in the direction of propagation. Traditionally, to find the solutions that constitute confined surface waves one assumes that a wave exists at the boundary and solves consequently the electromagnetic problem the problem with the appropriate boundary conditions. We have investigated the main properties of SPP and their dispersion relation with respect to the variation of the thickness of a multilayer structure (glass/oxide/metal/dielectric) at fixed exciting frequency (see fig. 1). It should be noted that large range of exciting frequency lead to a change in the value of the permittivity. The excitation of the SPP is due to the combination of the metal related to the presence of AZO/air interface and the exiting external electric field source with wavelength spanning from 300 to 700 nm. A three-dimensional model of the structure is created and constraints and parameters are applied on each subdomain and boundary, defining the necessary expressions for the incident wave, and setting the optical properties of the different domain. The numerical calculations and simulations for the resolution of electromagnetic field have been performed with the Finite Element Method (FEM) using the commercial software packages Comsol Multiphysics software to investigate the SPP in a multilayer structure of metal interfaces with dielectric (air) substrate.

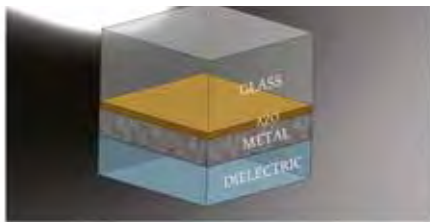

Fig. 1: Schematic structure of complete device with conductive aluminum-doped zinc oxide (AZO) film sandwiched between layers of metal and glass on dielectric.

Grazia Lo Sciuto (*Department of Engineering, Roma Tre University Rome, Via Vito Volterra 62, 00146 Rome, Italy, glosciuto@diu.unict.it*)

Giacomo Capizzi (*Department of Electronics and Informatics, University of Catania, Viale Andrea Doria 6, 95125 Catania, Italy, gcapizzi@diees.unict.it*)

FEM–NN Tool for the Simulation of Vector-Hysteresis in Magnetic Device

Ermanno Cardelli, Antonio Faba, Antonino Laudani, Gabriele Maria Lozito, Francesco Riganti Fulginei, Alessandro Salvini*

In this work, a Finite Element based tool for the analysis of magnetic field problems considering 2-D magnetic hysteresis is presented. In particular, this tool makes use of the FEM to solve the magnetic field problem in real devices, and fruitfully exploits a Neural Network (NN) to model 2-D magnetic hysteresis of materials. An important advantage of NN is that both direct (B from H) and inverse (H from B) models can be used to describe the material characteristic, so that different FEM formulations can be adopted for the solution of the same problem. The NN is trained by vector measurements performed on the magnetic material to be modeled or by using a vector model of a specific material to build the training set. Indeed another important advantage is related to the almost negligible computational cost of NN in the description of the material behavior with respect to the traditional vector hysteresis model. The FE solution of the resulting non-linear problem can be performed by adopting either the Newton-Raphson method (NRM) or Fixed-Point technique (FPT), or through hybridization of both techniques. In this way the overall computing process results acceptable in terms of computing time, and the FEM–NN tool can be used to reproduce the magnetic behaviour of complex devices, such as electrical machines or magnetic sensors, from low to higher frequencies. Validations through measurements on a real device have been performed. In particular, a round rotational single sheet tester (RRSST) has been modeled by FEM and the simulation results have been

compared with measurements, by considering the centre of the rotor for a Not Oriented Grain (NOG) magnetic steel core, excited by a circular magnetization.

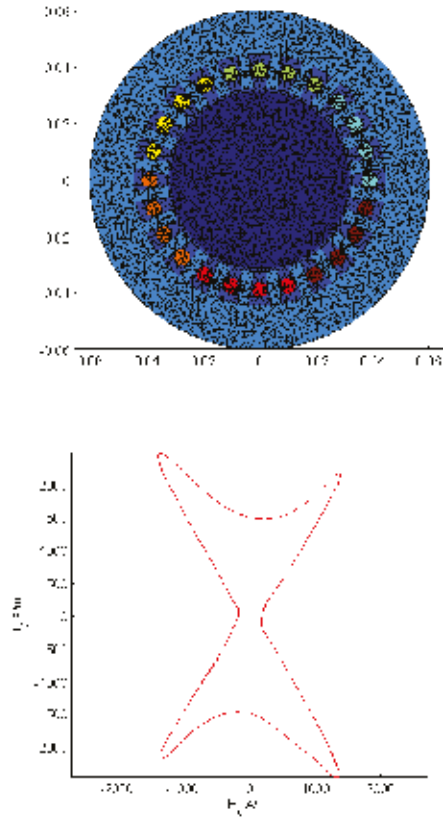

Fig. 1: 2-D mesh of the RRSST the magnetic field computed at its centre for a Not Oriented Grain (NOG) magnetic steel core.

Ermanno Cardelli, Antonio Faba (*Department of Engineering - University of Perugia, Via G. Duranti, 67 - 06125 Perugia, Italia*)

Antonino Laudani, Gabriele Maria Lozito, Francesco Riganti Fulginei, Alessandro Salvini (*Department of Engineering - Roma Tre University, Via V. Volterra, 62 - 00146 Roma gabriele maria.lozito@uniroma3.it*)

SESSION: S3

FEM IN ITALY (PART 2)

Organized by: Antonio Laudani, Alessandro Toscano

**Applications of Numerical Methods
in Metamaterials at Microwave Fre-
quencies**

*M.Barbuto, F. Bilotti, A.Monti, D.
Ramaccia, A. Tobia, A. Toscano, S.
Vellucci*

**FEM Simulations of Acoustic Meta-
surfaces**

*F. Asdrubali, F. Bilotti, P. Gori, C.
Guattari, A. Monti, D. Ramaccia, A.
Toscano*

**Volterra Series for an Iterative Finite
Element Time Domain Solution of
Wave Propagation in Nonlinear Me-
dia**

*S. Maddio, G. Pelosi, M. Righini, S.
Selleri*

**Design of Orthomode Transducers
Using FEM Software Packages**

G. Gentili, R. Nesti

**A FEM Aided Approach to Cost-
Effective Design of Direction Finding
Asymmetric Arrays**

L. Scorrano, L. Dinoi

Applications of Numerical Methods in Metamaterials at Microwave Frequencies

Mirco Barbuto, Filiberto Bilotti, Alessandro Monti, Davide Ramaccia, Antonino Tobia, Alessandra Toscano, Sabrina Vellucci

Recent studies in the field of electromagnetic invisibility at microwave frequencies have demonstrated that these techniques can be successfully used in several antenna scenarios to obtain unprecedented devices, such as low-observable sensors or miniaturized communication platforms composed by invisible transmitting antennas placed in close proximity. These results are usually based on the mantle cloaking technique (A. Alù, "Mantle cloak: Invisibility induced by a surface," *Phys. Rev B* **80**, 2009), an electromagnetic invisibility technique based on the use of metasurfaces, the 2D counterparts of metamaterials. The reliability of mantle cloaking is mainly due to the straightforward implementation of microwave metasurfaces as well as to the availability of rigorous analytical models allowing a quick and effective design.

Since the first appearance of mantle cloaking in the scientific literature, metasurfaces have been mainly used to achieve a low level of electromagnetic visibility of an object, *i.e.* a reduction of its Scattering Cross Section (SCS), through the employment of specific engineered cloaks based on metasurfaces. However, the possibilities offered by metasurfaces go beyond the results achievable by the mantle cloaking techniques. In this work, in particular, we present the conceptually new idea of camouflage that exploits the possibility offered by metasurfaces in the manipulation of the scattering properties of electrically small objects such as small spheres and cylinders.

From a theoretical perspective, the scattering field of an object is expressed as a sum of infinite scattering modes whose amplitude depends on the electrical dimension of the object itself. For electrically small objects, the first term of the scattering series dominates and the higher-order terms can be neglected. The fundamental order can be modified by a patterned metallic cover (*i.e.*, metasurface) described by a physical quantity known as surface

impedance Z_s , which is the ratio between the tangential component of the electric field and the surface current density. By a proper tailoring of the value assumed by Z_s , it is possible, thus, to modify the scattering field of a specific object to achieve a camouflaging effect, *i.e.* the transformation of the scattering properties of an object in the ones of another object.

This innovative idea finds natural application in the radar field where may be useful to camouflage an observed target. The camouflaging technique based on metasurfaces could also be useful in other applications field where, for geometrical or physical reasons, it is not possible to reduce the dimensions of an object leading, thus, to undesirable level of scattering. In such cases, with the use of properly designed metasurfaces wrapped around the objects, it is possible to modify their electromagnetic signature achieving a desired level of scattering and obtaining the same effect achievable by a reduction of its electrical dimension.

The contribution is based on an analytical and numerical investigations of the scattering properties of canonical electrically small objects, such as spheres and cylinders. The objective of the study is to identify a possible behavior of the metasurface impedance vs. the frequency, able to transform a particle in another ones in terms of angular distribution of the scattered field. A finite integration based time domain commercial solver is also used to confirm the theoretical results.

Mirco Barbuto (*"Niccolò Cusano" University, Via Don Carlo Gnocchi 3, 00166 Rome, Italy*)

Filiberto Bilotti, Alessandro Monti, Davide Ramaccia, Antonino Tobia, Alessandra Toscano, Sabrina Vellucci (*Engineering Department, "Roma Tre" University, Via Vito Volterra 62, 00154 Rome, Italy*)

FEM Simulations of Acoustic Metasurfaces

*Francesco Asdrubali, Filiberto Bilotti, Paola Gori, Claudia Guattari, Alessio Monti, Davide Ramaccia, Alessandra Toscano**

Acoustic metamaterials are investigated as an alternative to conventional acoustic materials

to achieve sound attenuation without the need of massive and bulky structures. In this work, very simple metamaterials-inspired surfaces composed by acoustically small inclusions have been studied. The geometric properties of such structures directly affect their reflection and transmission coefficients. Two different kinds of metasurfaces were studied by means of full-wave simulations, based on the finite-element method as implemented in the software COMSOL Multiphysics: a 2D configuration (Fig.1a), consisting in a water layer of thickness W_s , embedding an array of infinite air cylinders, with relative distance H , and a 3D geometry (Fig. 1b), in which the inclusions are a 2D array of air spheres. Both the radius of the cylinders or of the spheres and their relative distances are much smaller than the wavelength of operation. Floquet periodic boundary conditions have been employed. A single-frequency plane-wave pressure field propagates along the x-axis and through the metasurfaces. Both normal and oblique incidence were addressed. The linear wave equation was solved assuming fluid media and no losses. An array of cylinders with relative distance $H = 2.5$ cm, immersed in a water layer with thickness $W_s = 5$ cm was investigated. Fig. 2 shows the modulus of the transmission coefficient of such structures versus frequency for a few values of the radius a of the cylinders. For comparison, the transmission coefficient of a uniform water layer is also reported. A significant reduction of the pressure level, compared with the one obtainable with a layer without inclusions, can be achieved after the resonance peak. In the example shown, the lowest frequency above which the use of the metasurface proves advantageous ranges between 270 and 390 Hz. A remarkable stability of the metasurface behavior with respect to the incidence angle is observed. The other parameter that can be tuned to move the resonance peak of the structure is the distance H between the cylinders: its increase shifts the frequency peak to higher values. Similar results have been obtained also in 3D configurations, where both the radius a of the air spheres and the array pitch H control the resonance frequency above which there is a large low-transmission band.

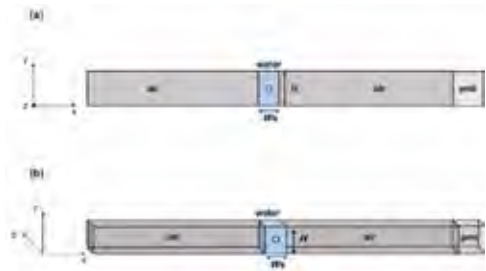

Fig. 1: Geometry of the problem for the metasurface with cylindrical inclusions (a) and with spherical inclusions (b). Pml denotes a perfectly-matched layer (dimensions not in scale).

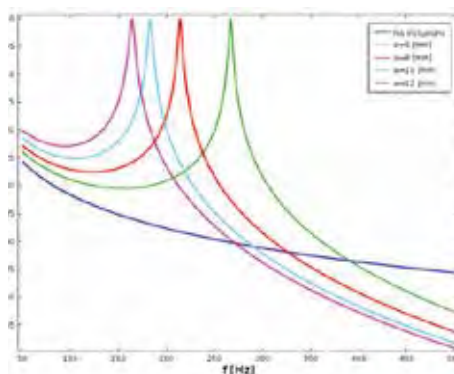

Fig. 2: Modulus of the transmission coefficient of an array of air cylinders in a water matrix ($H = 2.5$ cm).

Francesco Asdrubali, Filiberto Bilotti, Paola Gori, Claudia Guattari, Davide Ramaccia, Alessandro Toscano (Department of Engineering, Roma TRE University, Via Vito Volterra 62, 00146 Rome, Italy, francesco.asdrubali@uniroma3.it, filiberto.bilotti@uniroma3.it, paola.gori@uniroma3.it, claudia.guattari@uniroma3.it, davide.ramaccia@uniroma3.it, alessandro.toscano@uniroma3.it)

Alessio Monti (Department of Engineering, "Niccolò Cusano" University, Via Don Carlo Gnocchi 3, 00166 Rome, Italy, alessio.monti@unicusano.it)

Volterra Series for an Iterative Finite Element Time Domain Solution of Wave Propagation in Nonlinear Media

Stefano Maddio, Giuseppe Pelosi, Monica Righini, Stefano Selleri

Electromagnetic wave propagation in nonlinear media is a complex topic for which a numerical solution can be a daunting task. Frequency domain iterative solutions to the problem have been provided by some of the authors in the past (L. Ntubarikure, G. Pelosi, S. Selleri, "Efficient Harmonic Balance Analysis of Waveguide Devices With Nonlinear Dielectrics," *IEEE Microwave and Wireless Components Letters*, **22**, 5, 2012, pp. 221–223), but harmonic balance is computationally intensive of course not suitable for generic signals.

A more direct approach would be that of a time-domain simulation, but marching-in-time finite elements solutions require the inversion of a matrix, which can be done only once if the linear case, but which must be repeated at each step if material parameters are field dependent. This of course makes the simulation very CPU intensive and time consuming.

An alternative approach, for a nonlinearity expressed as a Volterra series (V. Volterra, "The theory of functionals and of integral and integrodifferential equations," Glasgow, UK: Blackie & Son., 1930) was presented by Franceschetti and Pinto ("The functional approach to nonlinear electromagnetics, Atti della Quarta riunione di Elettromagnetismo Applicato, Firenze 4-6 October 1982, pp. 91-96). In such a paper the nonlinear time-domain analysis is reconducted to a series of dependent linear analyses in which, in each analysis, material properties are a function of the fields computed at the previous steps.

Although iterative, the procedure, relying on linear analyses, is much more computationally efficient, as it will be shown at the conference.

Stefano Maddio, Giuseppe Pelosi, Monica Righini, Stefano Selleri (*Department of Information Engineering, University of Florence, Via di S. Marta 3, 50139 Florence, Italy, giorgio.battistelli@unifi.it*)

Design of Orthomode Transducers Using FEM Software Packages

Renzo Nesti, Gian Guido Gentili

Finite Element Method (FEM) is very powerful in the Electromagnetic (EM) analysis of many microwave passive devices. This is mainly due to the flexibility given by the finite element properties and procedures in meshing any arbitrary geometry and in the robustness of highly-efficient and very-accurate modern solvers.

Microwave devices with complex waveguide paths, where analytical method of analysis are very difficult to apply, are a set of problems in which the application of numerical techniques like FEM is most suited. This is the case for example of OrthoMode Transducers (OMTs) that, mainly at millimeter wavelengths, are most conveniently fabricated in waveguide technology.

OMTs are used in dual polarization systems when it is necessary to split two orthogonal signals, linearly polarized at 90 deg and sharing the same propagation medium, in two separated channels. In this contribution, a Q-band (33-50GHz) OMT with a circular waveguide input (sharing the two mixed orthogonal polarizations) and two rectangular waveguide outputs, each associated to one of the two polarizations, is presented.

The design of the OMT is decomposed in elementary EM problems (splitting junction, bends, combiners, transitions) each designed for high performance; these parts are then connected together to form the OMT which has been finally optimized as a whole. In both the elementary problem and whole OMT analysis, a FEM based software package has been used.

The particular application of interest demands for a high performance OMT: return loss better than 20 dB; cross polarization and isolation better than -35 dB, loss better than 0.5 dB. After accurate optimization of the EM model a mechanical solution has been found feasible to be fabricated as a prototype and EM test on the prototype showed very good performance in excellent agreement with FEM based analysis simulation.

Renzo Nesti (*Arcetri Astrophysical Observatory, Italian National Institute for Astrophysics, Largo Enrico Fermi 5, 50125 Firenze, Italy, nesti@arcetri.inaf.it*)

Gian Guido Gentili (*Department of Electronics Computer Science and Bioengineering Politecnico di Milano, Via Ponzio34/5, 20133 Milano, ITALY, gian-guido.gentili@polimi.it*)

A FEM Aided Approach to Cost-Effective Design of Direction Finding Asymmetric Arrays

Luca Scorrano, Libero Dinoi

The well-established theory of correlative Direction Finding (DF) techniques related to Uniform Circular Arrays (C.M. Tan, P. Fletcher, M.A. Beach, A.R. Nix, M. Landmann, R.S. Thoma, "On the application of circular arrays in direction finding. Part I: Investigation into the estimation algorithms," 1st Annual COST 273 Workshop, Espoo, Finland, 29-30 May 2002), turns out to be ineffective when dealing with small platforms or complex installation environments where regular arrays cannot be used for this purpose and a free line of sight is not available. When, in fact, the Direction of Arrival (DOA) is estimated by processing only phase measurements on the incoming signal, the correlation function used for DOA estimation is defined as follows:

$$\begin{aligned}
 CF(\psi, \theta, \psi_c, \theta_c, \omega) &= \\
 &= \frac{1}{N_b} \sum_{m=1}^{N_b} \cos[F_{m,A}(\psi, \theta, \omega) + \\
 &\quad - F_{m,B}(\psi, \theta, \omega) - F_{m,A}(\psi_c, \theta_c, \omega) + \\
 &\quad + F_{m,B}(\psi_c, \theta_c, \omega)] \quad (1)
 \end{aligned}$$

where N_b denotes the number of goniometric bases, built upon A_m and B_m antennas, while ψ_c and θ_c are, respectively, the azimuth and elevation angles of the calibration table and the antenna patterns defined as follows:

$$\begin{aligned}
 F_k(\psi, \theta, \omega, x, y) &= \\
 &= M_k(\psi, \theta, \omega, x, y) \exp[jF_k(\psi, \theta, \omega, x, y)] \quad (2)
 \end{aligned}$$

It is commonly found that even small perturbations of the regular array geometry is such

to greatly affect the DF performances of the array itself. The same unwanted effect is also experienced when antenna coupling is such to distort the antenna precisely-engineered radiated pattern. In particular, this very last phenomenon is always found in ultra-wideband arrays due to the circular symmetry of the antenna positions. In this contribution a FEM based approach to DF is presented, enabling a stochastic, rather than deterministic, design of the antenna array positions by genetic optimization based on far-field calculations. This design methodology takes advantage from antenna coupling to "ideally-unwanted" objects in close proximity to the array and from platform constraints by including a computational lightweight custom FEM code inside the DOA estimation algorithm. A custom FEM implementation is needed in order to fully benefit from the highly parallelizable nature of the proposed electromagnetic problem, suitable for a cloud-computing implementation.

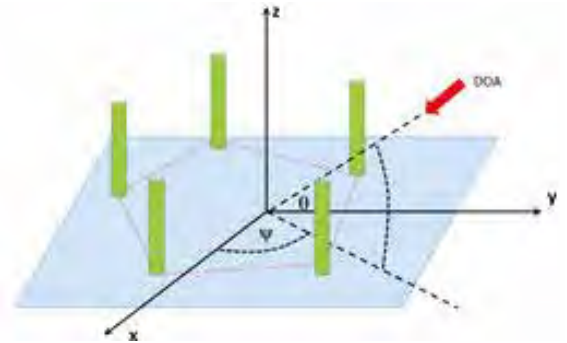

Fig. 1: DF array reference coordinate system.

Luca Scorrano (*Department of Research & Innovation, Elettronica S.p.A., Via Tiburtina Valeria Km 13.700, 00131 Roma, Italy, lucascorrano@ieee.org*)

Libero Dinoi (*Department of System & Product Engineering, Elettronica S.p.A., Via Tiburtina Valeria Km 13.700, 00131 Roma, Italy, libero.dinoi@elt.it*)

SESSION: S4

ACCELERATION/PRECONDITIONING TECHNIQUES FOR LARGE PROBLEMS

Organized by: Amir Boag, Balasubramaniam Shanker

Hierarchical Functions for Multiscale Problems

*R.D. Graglia, A.F. Peterson, P. Petrini,
L. Matekovits*

Linear Complexity Direct Finite Element Solvers for General Electromagnetic Forward Analysis and Inverse Design

B. Zhou, D. Jiao

Multilevel Nonuniform-Grid Algorithm for EM Scattering Problems

E.V. Chernokozhin, Y. Brick, G. Lombardi, R.D. Graglia, A. Boag

A Combined Mechanical-Electromagnetic Analysis of Dish Reflector Antennas

D.J. Ludick, D.B. Davidson, M. Venter, G. Venter

Novel Surface-Volume-Surface Electric Field Integral Equation for Solution of Scattering Problems on Penetrable Objects

F. Hosseini, A. Menshov, V. Okhmatovski

Babich's Expansion and the Fast Huygens Sweeping Method for the Helmholtz Equation at High Frequencies

J. Qian, W. Lu, R. Burridge

Hierarchical Functions for Multiscale Problems

Roberto D. Graglia*, Andrew F. Peterson, Paolo Petrini, Ladislau Matekovits

Recently, the authors have developed a number of new hierarchical and singular basis functions for field representation in two- and three-dimensional cells. Scalar and vector basis functions of both interpolatory and hierarchical kind together with some singular functions of the additive kind are discussed in detail, with several results, in a recent SciTech-IET book (R.D. Graglia and A.F. Peterson: *Higher-order Techniques in Computational Electromagnetics*), as well as in several other publications (for example, Graglia et al., IEEE TAP, vol. 61, pp. 3674–3692, Jul. 2013; IEEE TAP, vol. 62, pp 3632–3644, Jul. 2014; IEEE AWPL, vol. 13, pp 1701–1704, 2014, and in the special issue on “Finite Elements for Microwave Engineering,” *Electromagnetics*, vol. 34, pp. 171–198, 2014).

The singular basis functions reported to date by the authors are limited to triangular and quadrilateral two-dimensional cells. When used in conjunction with hierarchical functions, they permit the efficient handling of corner singularities in 2D FEM formulations. Singular additive functions for 3D cells have still to be derived. Conversely, the new three-dimensional hierarchical functions have been applied so far to simple canonical problems; the authors of the present paper have now started to explore their application to more complex 3D problems.

During the oral presentation at the conference we will show some new results obtained with hierarchical tetrahedral functions applied to microwave cavities, using vector Helmholtz FEM formulations. In particular, we will show the interaction between polynomial order, number of degrees of freedom, and condition numbers of the problem mass-matrix. We will also show that the accuracy of the solution is dramatically enhanced by increasing the order of the hierarchical polynomial basis subset. A method to derive singular basis functions for 3D cells will also be proposed, and new singular bases for the triangular prism element will be presented.

Roberto D. Graglia, Paolo Petrini (*Dipartimento di Elettronica e Telecomunicazioni, Politecnico di Torino, Corso Duca degli Abruzzi 24, 10129 Torino, Italy, roberto.graglia@polito.it*)

Andrew F. Peterson, Ladislau Matekovits (*School of Electrical and Computer Engineering, Georgia Institute of Technology, Atlanta GA 30332, USA, peterson@ece.gatech.edu*)

Linear Complexity Direct Finite Element Solvers for General Electromagnetic Forward Analysis and Inverse Design

Bangda Zhou, Dan Jiao

Driven by the design of advanced engineering systems, the complexity of computational electromagnetic methods need to be continuously reduced to meet the real-world challenges. The best complexity of the state-of-the-art finite element solvers for solving 3-D electromagnetic problems is $O(N_{it}N_{rhs}N)$ for iterative methods and $O(N^2)$ for direct methods, where N is matrix size, N_{it} is the number of iterations, and N_{rhs} is the number of right hand sides. Neither of the complexities has reached the optimal complexity of solving N parameters, which is $O(N)$.

In this work, we have developed a direct finite element solver of linear ($O(N)$) complexity for general 3-D electromagnetic analysis including both full-wave circuit extraction and the analysis of electrically large antennas. Both theoretical analysis and numerical experiments have demonstrated the solver’s linear complexity in CPU time and memory consumption with prescribed accuracy satisfied. The proposed direct solver has successfully analyzed an industry product-level full package involving over 22.8488 million unknowns in approximately 16 hours on a single core running at 3 GHz. It has also rapidly solved large-scale antenna arrays of over 73 wavelengths with 3,600 antenna elements whose number of unknowns is over 10 million. The proposed direct solver has been compared with the finite element methods that utilize the most advanced direct sparse solvers and a widely used commercial iterative finite

element solver. Clear advantages of the proposed solver in time and memory complexity as well as computational efficiency have been demonstrated.

Modeling and simulation alone is not sufficient. It has to encompass an inverse design algorithm that can actually solve the design challenge. In view of such a need, we have extended the proposed linear-complexity direct solver to the fast synthesis of the physical layout of electromagnetic structures. In this method, we convert the layout synthesis to an equivalent inverse problem, and we avoid the need for an optimization procedure as well as the many forward runs of electromagnetic simulators involved in prevailing optimization methods. Numerical experiments have validated the proposed synthesis algorithm.

Bangda Zhou, Dan Jiao (*School of Electrical and Computer Engineering, Purdue University, West Lafayette, IN 47907, USA, djiao@purdue.edu*)

Multilevel Nonuniform-Grid Algorithm for EM Scattering Problems

*Evgeny V. Chernokozhin**, Yaniv Brick, Guido Lombardi, Ladislau Matekovits, Roberto Graglia, Amir Boag

Electromagnetic scattering problems are often formulated using surface integral equations that are subsequently discretized via the method of moments (MoM). Solution of resulting linear systems with fairly large number of unknowns, N , by conventional iterative methods is hampered the fully populated nature of MoM matrices leading to $O(N^2)$ computation complexity (CC) of the matrix-vector multiplication and storage requirements of the same order. In this work, we extend the multilevel non-uniform grid (MLNG) algorithm (Y. Brick and A. Boag, "Multilevel non-uniform grid algorithm for acceleration of integral equation based solvers for acoustic scattering," *IEEE Trans. Ultrasonics, Ferroelectrics, and Frequency Control*, **57**, 2010, pp. 262–273) to facilitate efficient solution of integral equations of 3D electromagnetic scattering. In the MLNG algorithm, the matrix representa-

tion of the discretized integral operator is replaced with a less memory-consuming hierarchical tree-like structure corresponding to subdomains of the integration domain, which is subdivided into progressively smaller subdomains of progressively lower levels. For each subdomain, except for the top-level ones, the near and interpolation zones are defined, and to each of them an interpolation grid is assigned. For each observation point, there is a unique decomposition of the domain of integration into nonintersecting subdomains, such that this observation point belongs to the near zone of none of them, except for the nearest bottom-level subdomains. The tested field at a given observation point (as a result of the action of the integral operator on a given surface current) is represented by a sum of integrals over nonintersecting subdomains of different levels. The integrals over the bottom-level subdomains are evaluated by the direct integration, using the ordinary testing procedure. The integrals over higher level subdomains are evaluated in two stages: at first, the field from the grid assigned to the subdomain is interpolated to the test points of the given testing function; then the testing procedure for this function is applied. Only, the field on the interpolation grids assigned to the bottom-level subdomains is calculated by the direct integration. The field on the grids assigned to the higher level subdomains is calculated by the interpolation from the grids of the corresponding child domains. This procedure is characterized by an asymptotically $O(N \log N)$ CC, in contrast to the $O(N^2)$. CC of the straightforward multiplication of the surface current by the impedance matrix. The storage requirements of the MLNG algorithm are also asymptotically on the order of $O(N \log N)$.

An efficient iterative solver has been developed by combining the MLNG algorithm with the conjugate gradient method. The algorithm was implemented in a computer code for the electric field integral equation discretized using Rao-Wilton-Glisson (RWG) basis functions for perfectly conducting scatterers. The code performance was tested for various cases with up to $\sim 10^6$ unknowns and compared with that of a conventional code employing the same RWG basis. Except for problems with small scatterers, the "fast" code significantly outperforms

the conventional one in terms of both the storage requirements and computation time.

Evgeny V. Chernokozhin, Yaniv Brick (*Department of Physical Electronics, Tel-Aviv University, Tel-Aviv 69978, Israel, evg.chernokozhin@gmail.com, yaniv.brick@gmail.com, boag@eng.tau.ac.il*)

Guido Lombardi, Ladislau Matekovits, Roberto Graglia, Amir Boag (*Department of Electronics and Telecommunications, Politecnico di Torino, Corso Duca degli Abruzzi 24, 10129 Torino, Italy, guido.lombardi@polito.it, ladislau.matekovits@polito.it, roberto.graglia@polito.it*)

A Combined Mechanical-Electromagnetic Analysis of Dish Reflector Antennas

Daniel J. Ludick, David B. Davidson, Martin Venter, Gerhard Venter*

This work considers a combined structural-electromagnetic analysis of large reflector antennas typically used in radio astronomy applications. An example of such a project is the Square Kilometre Array (SKA). This next generation instrument will be built in Australia and South Africa and will have a total collecting area of more than one square kilometre. It will operate from 50 MHz to 14 GHz and will be 50 times more sensitive than any other radio instrument in existence. To cover this wide frequency range different types of antennas are being commissioned, of which large dish reflector antennas forms a critical component.

Precursors to the SKA that are focussed on developing these large dish reflectors include the South African KAT-7 and MeerKAT projects. The KAT-7 consists of 7 12m dishes operating from 1200 MHz to 1950 MHz. The MeerKAT is an extension of the KAT-7 and will eventually consists of 64 offset Gregorian telescopes with 13.5m diameter dishes. The purpose of this work is to quantify the effect of environmental factors, such as gravity, on the reflectors. A two-step approach is followed that commences with a finite element analysis of the reflector system that includes the backing support structure. Different load cases (e.g. gravitational loading for different dish tilting angles) are then applied to obtain deformed

geometries. The deformed structures are then analysed using a computational electromagnetic package from which the impact on the performance of the telescope can be assessed.

Daniel J. Ludick, David B. Davidson (*Department of Electrical and Electronic Engineering, Stellenbosch University, Stellenbosch, South Africa, dludick@sun.ac.za*)

Martin Venter, Gerhard Venter (*Department of Mechanical and Mechatronic, Stellenbosch University, Stellenbosch, South Africa*)

Novel Surface-Volume-Surface Electric Field Integral Equation for Solution of Scattering Problems on Penetrable Objects

*F. Hosseini, Anton Menshov, Vladimir Okhmatovski**

The integral equations (IE) of electromagnetics provide an alternative representations of the Maxwell equations which in many applications allow for more efficient computation of the electromagnetic fields than the method relying on the direct discretization of Maxwell equations. As such, Method of Moments (MoM) solution of IEs became the primary numerical technique for electromagnetic analysis of microstrip antennas and microwave circuits, solution of electrically large scattering problems, and solution of various other applied problems.

Scattering problems on penetrable homogeneous objects can be cast into the form of Combined Field Integral Equation (CFIE), PM-CHWT integral equation, or Muller integral equation. Each of the above IEs features two unknown vector functions (equivalent electric and magnetic currents) on the surface of the scatterer. These two vector functions are typically discretized with basis function on local support (such as Rao-Wilton-Glisson basis function) in order to obtain their numerical approximation. Since the number of the involved basis functions defines the size of the pertinent dense matrix equation, various techniques exist which eliminate one of the equivalent currents and, thus, reduce the size of the problem. Among such methods are Sin-

gle Source Integral Equation (SSIE) formulations and the methods utilizing complicated specialized Green's function satisfying particular boundary conditions required for elimination of one of the unknown surface currents. While both these techniques can lead to relatively efficient numerical schemes, generally, they are significantly more complicated to implement and suffer from various numerical inefficiencies. Specifically, the SSIE formulations feature either large number of matrix-matrix products if a direct method is utilized for solution of the resultant matrix equation or a large number of matrix-vector products if the dense matrix equation is solved iteratively.

In this work we discuss a new type of SSIE integral equation which we recently developed. The new SSIE features only one unknown vector function on the surface of the scatterer and is simple in implementation. The new SSIE is derived from the traditional Volume IE (VIE) through representation of the field in the volume of the scatterer as a superposition of the waves emanating from the scatterer's boundary and weighed with a single unknown surface vector function. Such field representation in the scatterer volume satisfies the same curl-curl wave equation as the true field. The surface based representation of the field in scatterer's volume upon substitution into VIE and localization of the observation points to the scatterer boundary reduces VIE to a SSIE. Thus obtained SSIE, however, features integral operators effecting field translation from the scatterer boundary to its volume and subsequent translation of the volumetric field distribution back to the scatterer's surface. Because of the above field translations the new SSIE is termed the Volume-Surface-Volume IE (SVS-IE). The new SVS-IE has been applied to solution of both scalar and vector scattering problems. In this presentation we discuss the MoM discretization of the SVS-IE and demonstrate various numerical results proving its validity.

F. Hosseini, Vladimir Okhmatovski (*Dept. of Electrical and Computer Engineering, University of Manitoba, Winnipeg, Canada, vladimir.okhmatovski@umanitoba.ca*)

Anton Menshov (*Dept. of Electrical and Computer Engineering, University of Texas at Austin, Austin, U.S.A., anton.menshov@utexas.edu*)

Babich's Expansion and the Fast Huygens Sweeping Method for the Helmholtz Equation at High Frequencies

Jianliang Qian, Wangtao Lu, Robert BurrIDGE*

In some applications, it is reasonable to assume that geodesics (rays) have a consistent orientation so that the Helmholtz equation can be viewed as an evolution equation in one of the spatial directions. With such applications in mind, starting from Babich's expansion, we develop a new high-order asymptotic method, which we dub the fast Huygens sweeping method, for solving point-source Helmholtz equations in inhomogeneous media in the high-frequency regime and in the presence of caustics. The first novelty of this method is that we develop a new Eulerian approach to compute the asymptotic, i.e. the traveltime function and amplitude coefficients that arise in Babich's expansion, yielding a locally valid solution, which is accurate close enough to the source. The second novelty is that we utilize the Huygens-Kirchhoff integral to integrate many locally valid wavefields to construct globally valid wavefields. This automatically treats caustics and yields uniformly accurate solutions both near the source and remote from it. The third novelty is that the butterfly algorithm is adapted to accelerate the Huygens-Kirchhoff summation, achieving nearly optimal complexity $O(N \log N)$, where N is the number of mesh points; the complexity prefactor depends on the desired accuracy and is independent of the frequency. To reduce the storage of the resulting tables of asymptotics in Babich's expansion, we use the multivariable Chebyshev series expansion to compress each table by encoding the information into a small number of coefficients.

The new method enjoys the following desired features. First, it precomputes the asymptotics in Babich's expansion, such as traveltime and amplitudes. Second, it takes care of caustics automatically. Third, it can compute the point-source Helmholtz solution for many different sources at many frequencies simultaneously. Fourth, for a specified number of points per wavelength, it can construct the wavefield in nearly optimal complexity in terms

of the total number of mesh points, where the prefactor of the complexity only depends on the specified accuracy and is independent of frequency. Both two-dimensional and three-dimensional numerical experiments have been carried out to illustrate the performance, efficiency, and accuracy of the method.

Jianliang Qian, Wangtao Lu (*Department of Mathematics, Michigan State University, East Lansing, Michigan, USA, qian@math.msu.edu, wangtaol@math.msu.edu*)

Robert Burrige (*Department of Mathematics and Statistics, University of New Mexico, Albuquerque, New Mexico, USA burridge137@gmail.com*)

SESSION: S5

INTEGRAL EQUATION / BEM METHODS

Organized by: Amir Boag, Balasubramaniam Shanker

The Integral Equation MEI revisited

J.M. Rius, A. Heldring, E. Ubeda

**Isogeometric Method of Moments
Analysis for Electric Field Integral
Equations Using Subdivision Surfaces**

J. Li, B. Shanker

**Graph Laplacian Based Algorithms
for Stable Current Discretizations on
Macro Elements**

R. Mitharwal, F.P. Andriulli

**From Surface Equivalence Principle
to Modular Domain Decomposition**

F. Muth, H. Schneider

**A Novel Mortar Surface Technique
for Modeling of Multi-Scale Strati-
fied Composites**

Z. Peng

The Integral Equation MEI Revisited

Juan M. Rius*, Alexander Heldring, Eduard Ubeda

Scattering from homogeneous dielectric media can be numerically modeled either with finite difference or with integral equations methods. The former need the discretization of the whole domain under analysis, but lead to a sparse linear system that can be stored and solved very efficiently. The later discretize only the domain boundary, resulting in a linear system with a much lower number of unknowns (N), but having a full matrix that requires high computational resources of order N^2 and N^3 for storage and solution, respectively.

The best of both worlds can be achieved if the full IE-MoM matrix is sparsified by using sets of basis and testing functions that radiate narrow beams and thus produce impedance matrices containing many small elements, which can be dropped to zero. This techniques include, for instance, the Impedance Matrix Localization (IML) method and the wavelets expansions. The Integral Equation formulation of the Measured Equation of Invariance (IE-MEI) was developed as an integral equation discretization scheme for perfectly conducting (PEC) boundaries that, using the Measured Equation of Invariance (MEI) concept, produced a sparse linear system for convex scatterers. The relevant references can be found in (Juan M. Rius et al., “The Integral Equation MEI applied to three-dimensional arbitrary surfaces”, *IEE Electronics Letters*, **33**(24), 1997, pp. 2029-2031).

The IE-MEI is in fact a special case of the Combined Field Integral Equation (CFIE) discretized by the Method of Moments (MoM), in which the choice of different testing functions for the electric and/or the magnetic fields results in an approximately sparse CFIE, EFIE or MFIE linear system to solve for the induced current, where most of the matrix elements can be neglected. These new testing functions are numerically derived by solving small linear systems as in the MEI method. A significant feature of numerically derived testing functions is that they are adaptive, i.e., specific to the particular shape of the scatterer boundary and to the location of the function in the boundary.

The computational cost and storage requirements of IE-MEI for 2D perfectly conducting scatterers of arbitrary convex shape are of order $O(N)$, which is to our knowledge the best performance ever achieved by numerical methods for this class of scatterers: the linear system to invert has a band cyclic matrix of very small bandwidth independent from N , that can be stored and solved in $O(N)$ memory and time. The IE-MEI matrix coefficients can be computed at a frequency lower than the operating frequency and then extrapolated to the higher frequency (Juan M. Rius et al., “Frequency Extrapolation in the Integral Equation MEI”, *IEE Electronics Letters*, **32**(25), 1996, pp. 2324-2326), so that for electrically very large objects the time required to compute the coefficients (corresponding to the smaller problem at a lower frequency) is negligible compared to the linear system solution, resulting in an overall operation count proportional to the number of unknowns, N .

The IE-MEI was applied to 3D perfectly conducting scatterers modeled with Rao, Wilton and Glisson basis functions, but since (i) the sparsity of the linear system matrix was not enough, (ii) the computational cost to compute the MEI coefficients was of order $O(N^2)$ and (iii) frequency extrapolation was not implemented due to the difficulty of handling the topology of 3D surface meshes, the overall performance of IE-MEI in 3D was much worse than that of $O(N \log N)$ fast solvers like the MLFMA.

20 years later, we revisit the IE-MEI idea in order to widespread it among young researchers and fertilize the field to encourage new work that may overcome the difficulties and improve the efficiency of the IE-MEI in 3D.

Juan M. Rius, Alexander Heldring, Eduard Ubeda (*Universitat Politècnica de Catalunya - BarcelonaTech (Spain), rius@tsc.upc.edu*)

Isogeometric Method of Moments Analysis for Electric Field Integral Equations Using Subdivision Surfaces

*Jie Li, Balasubramaniam Shanker**

The framework of constructing isogeometric analysis (IGA) on parametric surface (mainly non-uniform rational B-splines or NURBS based surfaces) was proposed in the work (T.J.R. Hughes, J.A. Cottrell and Y. Bazilevs, “Isogeometric analysis: CAD, finite elements, NURBS, exact geometry and mesh refinement, *Computer Methods in Applied Mechanics and Engineering*,” vol. 194, 2005, pp. 4135–4195), mainly for solving a class of partial differential equations (PDEs). The fundamental idea lies in the unifying representing smooth geometry and field distributions, owing to the continuity of partition of unity properties of the basis functions.

The IGA is attractive in numerical simulation because of the easy implementation of h - and p - refinement in the mesh-free manner, especially when working with NURBS. Besides the wide popularity of NRUBS in IGA studies, subdivision surface has also been used for the same purpose. Subdivision surface is equipped with its powerful capabilities for arbitrary topologies and easy multiresolution analysis.

Studies on IGA of PDEs arising from computational mechanics (and related subjects) have been growing during the last ten years. Applications to integral equations arising from time harmonic electromagnetic field analysis are quite sparse, especially using subdivision surface. In this presentation, application of subdivision surface into solving integral equation in electromagnetics will be discussed. Topics to be discussed include (1) how to construct IGA framework using subdivision to solve the EFIE for tangent currents, (2) solution to the low-frequency breakdown in IGA and (3) Calderón preconditioning.

Jie Li, Balasubramaniam Shanker (*Department of Electrical and Computer Engineering, Michigan State University, 428 S Shaw Ln, East Lansing, MI 48824, USA*)

Graph Laplacian Based Algorithms for Stable Current Discretizations on Macro Elements

Rajendra Mitharwal, Francesco P. Andriulli*

Boundary element methods (BEM) for electromagnetic problems are nowadays considered one of the key technologies in both academic and commercial simulation tools. When simulating radiation and scattering from metallic or homogeneous dielectric objects, the main advantage of these solvers with respect to other simulation strategies stands in the fact that they discretize only the scatterer’s surface and automatically impose radiation conditions at infinity. Moreover, the advent of fast solvers has lowered the computational cost of BEM matrix vector product to quasi-linear complexity. When the BEM linear system is solved iteratively, this translates in an overall linear complexity for the solution if the number of iterations is constant. The latter condition is verified only when well conditioned formulations are adopted. One of the most used integral equations is the Electric Field Integral Equation (EFIE), whose operator maps an electric current in the radiated electric field. The EFIE operator is severely ill-conditioned both for low frequencies and for dense discretizations and several families of remedies have been proposed to solve this problem based on the regularization of the EFIE operator spectrum. An alternative and often complementary strategy to mitigate the ill conditioning of the EFIE due to dense discretization is the reduction of the equation’s degrees of freedom. This can be achieved by using macro elements such as the Characteristic Basis functions, the Synthetic basis functions, or related domain decomposition schemes. These approaches reduce the EFIE’s degrees of freedom by relying on a field based analysis which, for a given right hand side of the EFIE, extracts the relevant functions that are responsible for the electromagnetic solution. This talk will frame in a slightly different approach, focusing on extracting macro degrees of freedom based on a current analysis. This approach will be RHS independent and will be based on a computationally effective generalization of the RWG basis functions on macro domains. We will fo-

cus on a new family of algorithms, based on graph Laplacians and quasi-Helmholtz projectors, which will allow to recover these current-based degrees of freedom in a purely linear complexity and in a stable way uniformly in the mesh parameter. Numerical results will show the effectiveness of the new approaches and their applicability to real case scenarios.

Rajendra Mitharwal, Francesco P. Andriulli (*Computational Electromagnetics Research Laboratory Télécom Bretagne / Institut Mines-Telecom, Technopole Brest-Iroise, 29238 Brest Cedex 3, France/Italy, rajendra.mitharwal@telecom-bretagne.eu, francesco.andriulli@telecom-bretagne.eu*)

From Surface Equivalence Principle to Modular Domain Decomposition

Florian Muth and Hermann Schneider*

For the simulation of complex electromagnetic models involving multiple scales and different properties, it is often appropriate to apply domain decomposition methods. From the surface equivalence principle as starting point, a modular, black box framework for domain decomposition has been developed based on [Z.Peng, J. F. Lee, *Non-conformal domain decomposition with second-order transmission conditions for time-harmonic electromagnetic*, Journal of Computational Physics, Vol. 229, pp 5615–5629. 2010]. It allows for assigning any formulation and numerical method to a certain subdomain. In this approach, equivalent surface currents act as interface between subdomains exchanging boundary data.

This study focuses on coupling finite element and boundary element frequency domain methods driven by application examples like antenna placement. The convergence of the iterative solver, which is used for the described domain decomposition, and its dependence on parameters like the number of subdomains or the coupling strength are studied for a patch antenna array. CST's finite element frequency domain solver is used to calculate each subdomain and a simple absorbing boundary condition is applied.

Further investigations are made concerning the relationship between the residual of the iteratively solved linear equation system and the

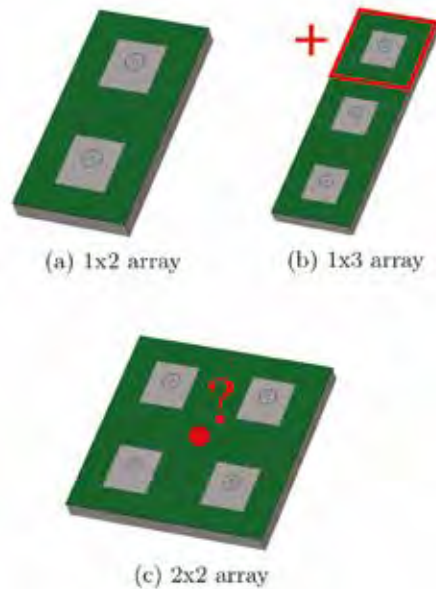

Fig. 1: In this study, the 1x2 array (a) is extended by an additional element to a 1x3 array (b) and to a 2x2 array (c) introducing potentially problematic cross-points.

errors in the quantities of interest (e.g. S-parameter), the potentially problematic cross-points, and the definition of an appropriate stopping criterion. First results will be presented for a simpler setup and the patch antenna array, see Figure 1.

Florian Muth, Hermann Schneider (*Computer Simulation Technology AG, Germany, Florian.Muth@cst.com, Hermann.Schneider@cst.com*)

A Novel Mortar Surface Technique for Modeling of Multi-Scale Stratified Composites

Zhen Peng

In recent years, multi-layer radar absorbing materials are routinely applied as effective surface treatments on stealth targets in order to reduce the radar signature. For example, a unit cell of an effective broadband multi-layer radar absorber may be constructed by three layers of periodic resistive square patches and two layers of frequency selective surfaces (FSSs) embedded within six dielectric layers.

Such a complex, ultra-thin (10mm) absorber, denoted by the so-called “composite skin”, will be coated on the large part of the surface of stealth targets. The accurate analysis of this highly complex composite platform may be computationally prohibitive using current numerical algorithms. Moreover, Moreover, increased demands are being placed on an integrated design and analysis environment. At conceptual design stage, individual components (FSS, resistive sheet, etc.) in the composite skin are often modified on a daily basis. It puts a high premium on new computational tools capable of component oriented optimization, discretization and simulation. In this work, we investigate a geometry-aware integral equation based domain decomposition method (GA-IE-DDM) to conquer the geometric complexity and resolve the intricacy of materials in sophisticated EM composite objects. It allows generating analysis-suitable models per-component, analyzing individual components independently, and automating assembly of multiple components to obtain the virtual prototyping of entire product. A novel mortar surface technique is proposed, which successfully decouples the resistive and FSS sheets from the dielectric layers. These sheet structures will be treated as independent plug-in-play sub-domains, which allow us to modify their design without the need for updating/editing the other parts of the virtual prototype. Moreover, the introduction of mortar surface technique also leads to fast algorithms which are not restricted to specific assumptions on small scales.

Zhen Peng (*Department of Electrical and Computer Engineering, University of New Mexico, Albuquerque, NM 87131-0001, USA, E-mail: pengz@unm.edu*)

SESSION: S6

ADVANCED FEM AND HYBRID TECHNIQUES (PART1)

Organized by: Branislav Notaroš, Juan Zapata

Second-order Nédélec Curl-Conforming Prism for Finite Element Computations

A. Amor-Martin, L.E. Garcia-Castillo

Analysis of 3D Components by 2D FEM

G. G. Gentili, L. Accatino

Exact Discrete Electromagnetism by Sampling and Interpolation

E. Scholz, S. Lange, T. Eibert

A CAD Method based on Hybrid FEM and Spherical Modes for Direct Domain Decomposition

P. Robustillo, J. Rubio, J. Zapata, J.R. Mosig

Finite Element 1-D Solutions in the Presence of Moving Media

A.Ž. Ilić, S.V. Savić, M.M. Ilić,

Nonrigorous Symmetric Second-Order Absorbing Boundary Condition: Accuracy, Convergence and Possible Improvements

S.V. Savić, A.Ž. Ilić, B.M. Notaroš, M.M. Ilić

Second-Order Nédélec Curl-Conforming Prism for Finite Element Computations

Adrian Amor-Martin, Luis Emilio Garcia-Castillo

Curl-conforming finite elements have been object of intensive research in the electromagnetic community during the nineties and early '00s providing stable discretization schemes for the electromagnetic field within the context of full wave vector formulations in electromagnetics. Two main types of curl-conforming elements may be distinguished depending of whether they are complete up to some order (in the polynomial sense) or not. The latter elements are called mixed order elements as they provide a mixed order approximation of the field while the approximation of the curl remains complete of one order less (as in their complete order counterpart)

A systematic approach to obtain mixed order curl-conforming basis functions for the prism is presented; focus is made on the second-order case. Space of functions for the prism is given. Basis functions are obtained as dual basis with respect to properly discretized Nédélec degrees of freedom functionals abstractly defined in J. C. Nédélec, "A new family of mixed finite elements in \mathbb{R}^3 ," *Numerische Mathematik*, vol. 50, pp. 57–81, 1986.) acting on elements of the space. Thus, the linear independence of the basis functions is assured while the belonging of the basis to the a-priori given space of functions is guaranteed. Different strategies for the finite element assembly of the basis are discussed. Numerical results showing the verification procedure of the correctness of the implemented basis functions are given. Numerical results about sensibility with respect to quality of the elements of the mesh of the condition number of the basis obtained are also shown.

Adrian Amor-Martin, Luis Emilio Garcia-Castillo (*Department of Signal Theory and Communications, University Carlos III of Madrid, Leganés, Spain, e-mail: amor@tsc.uc3m.es, luise@tsc.uc3m.es*)

Analysis of 3D Components by 2D FEM

Gian Guido Gentili*, Luciano Accatino

The accuracy and efficiency of FEM is strongly dependent on its capability to represent accurately the fields in structures of arbitrary shape and size. Although the most general case requires a full 3D FEM formulation, there is a class of components (mostly waveguide components) in which one of the dimensions in piecewise constant. In this rather wide category we find several filters, junctions, ortho-mode transducers (OMT, figure), polarizers and textured surfaces.

All these cases can be analyzed by a so called 2.5D FEM formulation, in which the dependency of the fields along one coordinate (y-axis in the figure) is of sinusoidal type. For each sinusoid a 2D problem is solved and all the solutions are then combined to form a full 3D solution to the original problem.

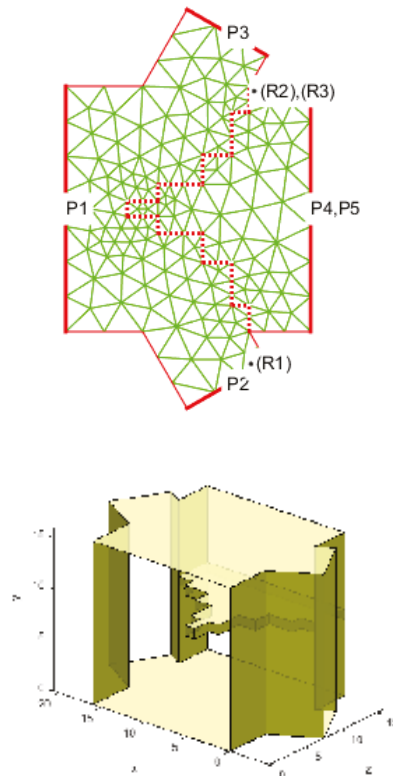

Fig. 1: Geometry of the problem and mesh.

There are several advantages in the use of this technique with respect to full 3D FEM: a much better compromise between accuracy and efficiency (either can be improved by at least one order of magnitude w.r.t. 3D FEM) and an easy parallelization (each 2D problem can be assigned to a dedicated processor, with a further boost of the overall performances).

We have analyzed several structures with this method, namely a septum polarizer, the central block of an OMT, a waffle-iron low pass filter and a dielectric resonator filter. In all cases the results obtained were excellent in terms of accuracy and efficiency. A very important feature of the method is the possibility to use direct solvers in the problem solution. This allows the computation of the Generalized Scattering Matrix for a large number of input modes, a task that is still time consuming with nowadays commercial 3D FEM codes.

Gian Guido Gentili (*Department of Electronics, Information and Bioengineering, Politecnico di Milano, Via Ponzio 34/5, I-20133, Milano (Italy), gentili@elet.polimi.it*)

Luciano Accatino (*AC Consulting, Via Trieste 16/B, Rivoli (To), Italy*)

Exact Discrete Electromagnetism by Sampling and Interpolation

Eike Scholz, Sebastian Lange, Thomas Eibert

In this work we propose a detailed version of exact discrete electromagnetism as an encompassing generalization of finite element methods (FEM). It has been developed with the analysis of large complex systems in mind and entails a new fully coupled numerical version of topological decomposition. We discuss stability, and as a guiding example, the theory is applied to coaxial transmission lines using uncommon features like overlapping cells. Finally it is tested for validity using a mixture of analysis and numerical experimentation.

We start our derivation using Maxwell's equations

$$\mathbf{curl}\mathbf{H} = \frac{\partial}{\partial t}\epsilon\mathbf{E} + \kappa\mathbf{E} + \mathbf{J}$$

$$-\mathbf{curl}\mathbf{E} = \frac{\partial}{\partial t}\mu\mathbf{H} + \kappa_m\mathbf{H} + \mathbf{J}_m$$

and proceed to develop a generalized discretized version of them. For this we define degrees of freedom and interpolation functions using explicit operators. Thus, following the ideas in (E. Scholz, S. Lange, T. Eibert, "Exact Discrete Electromagnetism for Electromagnetic System Security", EMC Europe, 2014, 1-4 Sept. 2014), we first select a suitable Hilbert space \mathcal{H} that at least contains all physically possible fields. To calculate degrees of freedom we select a sampling operator $\mathcal{S} : \mathcal{H} \rightarrow \mathbf{R}^N$ that expresses sampling data as a vector in \mathbf{R}^N . Further, to construct numerical field approximations, a finite dimensional subspace $\mathcal{H}^N \subset \mathcal{H}$ as well as a linear interpolation operator $\mathcal{J} : \mathbf{R}^N \rightarrow \mathcal{H}$ are selected. Usually this operator is simply given as $\mathcal{J} = \sum_i \psi_i$ where ψ_i denotes a set of linearly independent ansatz functions. The so-called hat-functions of the finite element method could be used, for example. These operators allow the construction of algebraic projection operators by $\mathcal{S} = \mathcal{J}\mathcal{Q}^{-1}$ with $\mathcal{Q} := \mathcal{S}\mathcal{J}$ that can be used to approximate material operators. For example, a given permittivity $\tilde{\epsilon} := \mathcal{P}_d\epsilon\mathcal{P}_e$ using two projections, one for the displacement field and one for the electric field. Assuming that there exist discrete curl operators for the selection of sampling and interpolation operators, we show that solving Maxwell's equations with the thus created approximate materials is under weak constraints exactly equivalent to solving a corresponding ordinary differential equation system

$$\begin{aligned} \mathbf{C}_h\mathbf{h} &= \frac{\partial}{\partial t}\mathbf{M}_e\mathbf{e} + \mathbf{K}_e\mathbf{e} + \mathbf{j}_e \\ -\mathbf{C}_e\mathbf{e} &= \frac{\partial}{\partial t}\mathbf{M}_h\mathbf{h} + \mathbf{K}_h\mathbf{h} + \mathbf{j}_h \end{aligned}$$

where \mathbf{C}_h and \mathbf{C}_e are discrete curl operators, \mathbf{M}_e is a discrete permittivity, \mathbf{M}_h is a discrete permeability, \mathbf{K}_e is a discrete conductivity, and \mathbf{K}_m is a discrete magnetic conductivity. We show that all the material operators can be computed in a straight forward way from the sampling and interpolation operators. This general result is then used to model a simple coax transmission line, using a FEM-like approach with exotic features like overlapping cell domains and closed loop integrals as degrees

of freedom. Finally we numerically investigate the solution of the discrete system as well as its stability.

Eike Scholz, Thomas Eibert (*Technical University of Munich, Chair of High-Frequency Engineering, Arcisstraße 21, 80333 München*)

Sebastian Lange (*Wehrwissenschaftliches Institut für Schutztechnologien - ABC-Schutz, Humboldtstraße 100, 29633 Munster*)

A CAD Method Based on Hybrid FEM and Spherical Modes for Direct Domain Decomposition

Pedro Robustillo, Jesús Rubio, Juan Zapata, S. Juan R. Mosig*

Direct Domain Decomposition Methods (DDDM) are well known in waveguide problems since they provide design capabilities. One of the most efficient way of implementing a DDDM consists of expanding the field on the interfaces in terms of waveguide modes. For this purpose, the most usual analytical expansions in terms of coaxial, rectangular or circular waveguide modes have been used (J. Rubio, J. Arroyo, J. Zapata, Analysis of passive microwave circuits by using a hybrid 2-D and 3-D finite-element mode-matching method, *IEEE Trans. Microwave Theory and Tech.*, vol. 47, 1999, pp. 1746–1749). Although DDDM have been widely used for fast waveguide circuits analysis, they have been barely applied to radiation problems.

In this work, a DDDM based on spherical mode expansion for spherical or hemispherical interfaces is proposed. Convergence problems associated to these expansions on concave spherical ports will be discussed in order to choose the most adequate expansion in terms of incident/reflected waves or, alternately, standing waves. It will be also shown how the capabilities of the method can be strongly increased by using properties of rotation and translation of spherical modes.

Finally, the method will be applied to the analysis of on-board spacecraft antennas and lens based antenna systems.

Pedro Robustillo, S. Juan R. Mosig (*Ecole Polytechnique Fédérale de Lausanne, Lausanne, Switzerland, pedro.robustillo@epfl.ch, juan.mosig@epfl.ch*)

Jesús Rubio (*Escuela Politécnica, Universidad de Extremadura, Cceres, Spain, jesusrubio@unex.es*)

Juan Zapata (*ETSIT, Universidad Politécnica de Madrid, Madrid, Spain, jzapata@etc.upm.es*)

Finite Element 1-D Solutions in the Presence of Moving Media

Andjelija Ž. Ilić, Slobodan V. Savić, Milan M. Ilić*

The efficiency and versatility of the finite element method (FEM) in solving problems that involve complex, inhomogeneous and/or anisotropic variation of media parameters, advocates its utilization in both cutting-edge theoretical investigations and advanced real-world applications. Recently, we have proposed and developed a higher-order frequency-domain FEM technique for analysis of one-dimensional (1-D) electromagnetic (EM) problems involving moving media. The proposed method seems to be the first full-wave higher-order method of its kind. It has been validated against the analytical solutions, in two of the cases where these were available, namely, for the single-layer dielectric slab with the homogeneous permittivity and with the linearly varying permittivity (A.Ž. Ilić and M.M. Ilić, “Higher-order frequency-domain FEM analysis of EM scattering off a moving dielectric slab”, *IEEE Antennas and Wireless Propagation Letters*, vol. 12, pp. 890–893).

This paper investigates electromagnetic waves interaction with moving media consisting of multiple layers with continuously inhomogeneous media parameter profiles and nonuniform partial layer velocities. We perform detailed scattering analysis with respect to the layer velocities, plane wave polarization, angle of incidence, and media parameter profiles, considering both low and high velocities of the moving slabs. We discuss establishing of both natural and essential boundary conditions and the Lorentz transformations leading

to the appropriate FEM formulation. Convergence analysis is conducted with respect to the h -refinement and p -refinement. Reasons for the solution convergence breakdown are discussed, where applicable.

Applications of the novel FEM technique include the interaction of external EM fields with plasma jets for space propulsion and the applications to plasma wakefield acceleration (PWFA).

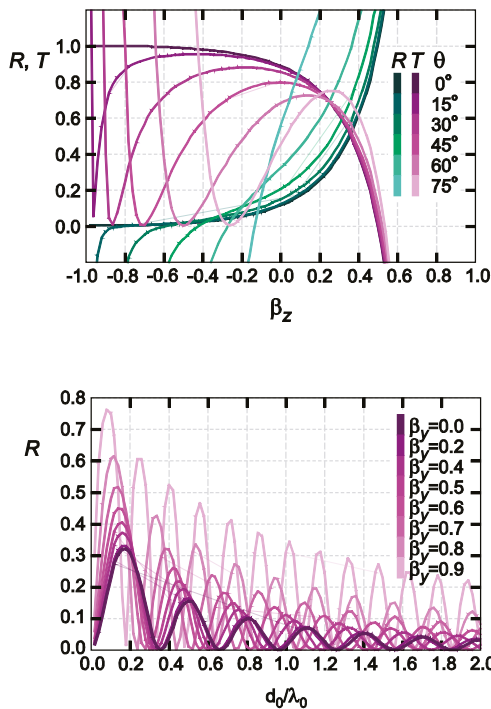

Fig. 1: top: Reflection and transmission coefficients for the homogeneous dielectric half-space ($\epsilon_r = 4$) moving in direction of plane wave propagation, for different angles of incidence θ . bottom: Reflection coefficients for the inhomogeneous slab with parabolic profile of relative permittivity, with maximum permittivity ($\epsilon_r = 4$) in the middle of the slab ($z = d_0/2$), and $\epsilon_r = 1$ at the slab–vacuum interfaces. Slab movement is transversal to direction of propagation of the normally incident plane wave.

Andjelija Ž. Ilić (*Institute of Physics, University of Belgrade, Pregrevica 118, 11080 Zemun-Belgrade, Serbia, andjelijailic@iee.org*)

Slobodan V. Savić (*School of Electrical Engineering, University of Belgrade, Bulevar Kralja Aleksandra 73, 11120 Belgrade, Serbia, milanilic@etf.rs*)

Milan M. Ilić (*Department of Electrical and Computer Engineering, Colorado State University, 1373 Campus Delivery, Fort Collins, CO 80523-1373, USA*)

Nonrigorous Symmetric Second-Order Absorbing Boundary Condition: Accuracy, Convergence and Possible Improvements

Slobodan V. Savić, Andjelija Ž. Ilić, Branislav M. Notaroš, Milan M. Ilić*

Approximate (local) absorbing boundary conditions (ABCs) are important and widely used means for truncation of computational domain in the finite element method (FEM) analysis of open electromagnetic (EM) problems in the frequency domain. Among ABCs, a symmetric second-order ABC appears to be a naturally preferred choice. On the other hand, this choice requires computation of the divergence term on the faces of elements belonging to the absorbing boundary surface (ABS) which is problematic because (i) the normal continuity of the fields is not enforced between adjacent elements in a standard weak-form discretization and (ii) analytical computation of divergence on div-nonconforming vector basis functions is not possible for the generalized curved finite elements. The influence of divergence term and its computation have been previously studied (V. N. Kanellopoulos and J. P. Webb, “The importance of the surface divergence term in the finite element-vector absorbing boundary condition method,” *IEEE Trans. Microw. Theory Techn.*, **43**, 1995, pp. 2168–2170) and an excellent rigorous symmetric FEM implementation has been proposed (M. M. Botha and D. B. Davidson, “Rigorous, auxiliary variable-based implementation of a second-order ABC for the vector FEM,” *IEEE Trans. Antennas Propag.*, **54**, 2006, pp. 3499–3504). However, all thus far reported conclusions pertain to analysis of the second-order ABC in small-domain FEM discretizations (where the sizes of finite element

edges are on the order of $\lambda/10$, λ being the wavelength at the operating frequency in the considered medium). In our recent work (S. V. Savić et al. "Accuracy analysis of the nonrigorous second-order absorbing boundary condition applied to large curved finite elements," *ICEAA 2015* Turin, Italy, 2015, pp. 58–61) we have reported our preliminary results on the analyses of performance of the nonrigorously implemented second-order ABC in coarse large-domain FEM meshes in the vicinity of ABS, which typically resides in free space, away from discontinuities. In this work we report the new results of our ongoing validation of accuracy of the proposed nonrigorous second-order ABC truncation method, with emphasis on the near field computations. Numerical models involve large-domain discretizations with curved finite elements and with truly higher order polynomial field expansions. The study includes both total-field and scattered-field FEM formulations, and possible improvements of truncation accuracy. Near field error comparison for a spherical PEC scatterer, of radius $a = 1$ m with ABS radius $b = 1.5$ m, for the first-order ABC and the proposed second-order ABC in $y = 0$ plane at $f = 300$ MHz are shown in Fig. 1.

Slobodan V. Savić (*School of Electrical Engineering, University of Belgrade, Bulevar Kralja Aleksandra 73, 11120 Belgrade, Serbia, milanilic@etf.rs*)

Andjelija Ž. Ilić (*Institute of Physics, University of Belgrade, Pregrevica 118, 11080 Zemun-Belgrade, Serbia, andjelijailic@iee.org*)

Branislav M. Notaroš, Milan M. Ilić (*Department of Electrical and Computer Engineering, Colorado State University, 1373 Campus Delivery, Fort Collins, CO 80523-1373, USA, notaros@colostate.edu*)

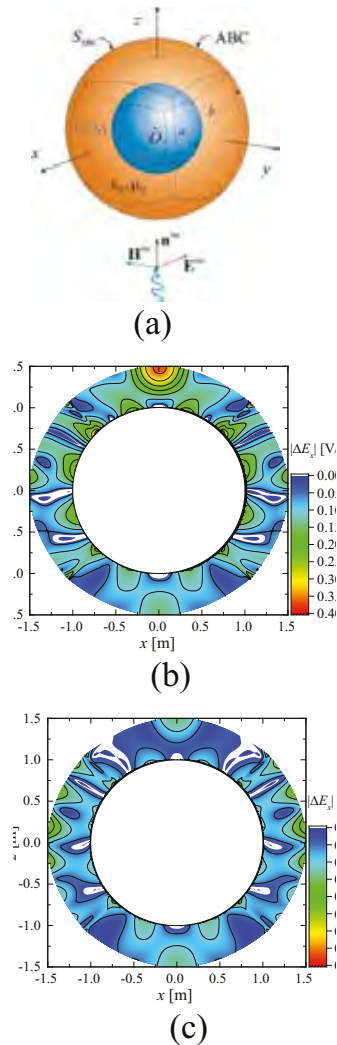

Fig. 1: (a) PEC spherical scatterer and absolute errors of computed electric field obtained by (b) the first-order ABC and (c) the proposed nonrigorous second-order ABC.

SESSION: S7

ADVANCED FEM AND HYBRID TECHNIQUES (PART 2)

Organized by: Branislav Notaroš, Juan Zapata

Posidonia: A Tool for HPC and Remote Scientific Simulations

*A. Amor-Martin, I. Martinez-Fernandez,
L.E. Garcia-Castillo*

Evaluation of Galerkin Interactions between Surface or Volumetric Elements

*J. Rivero, F. Vipiana, D. R. Wilton, W.
A. Johnson*

FEM-BCI: a Set of Hybrid Methods for the Computation of Electromagnetic Fields in Open Boundaries

G. Aiello, S. Alfonzetti, N. Salerno

The Efficient Mixed FEM with Mass-Lumping and Impedance Transmission Boundary Condition for Computing Optical Waveguide Modes

N. Liu, G. Cai, Q.H. Liu

A New 3D DGTD Method Hybridizing the Finite Element and Finite Difference Techniques with Non-Conformal Meshes

Q. Sun, Q. Ren, Q. Zhan, Q.H. Liu

Multiscale Finite Element Modeling for Composite Material Characterization

B.-Y. Wu, X.-Q. Sheng, Y. Hao

Posidonia: A Tool for HPC and Remote Scientific Simulations

Adrian Amor-Martin, Ignacio Martinez-Fernandez, Luis Emilio Garcia-Castillo

Nowadays, the use of HPC (High Performance Computing) systems in electromagnetic simulation is playing a key role in electrical and electronic engineering. The use of these systems is often difficult to learn for novice users and even for experimented users is tedious since many tasks are automatic. In order to use a HPC system in an effective way, the user is required to acquire knowledge, among others, of the specific hardware platform, operating system, job scheduler and application program to be run. A cross-platform tool specifically developed to simplify this procedure has been developed. It is named Posidonia. Posidonia removes the barrier to entry for the novice user of HPC systems, and remote scientific simulations in general, while increasing productivity. Posidonia manages communication with the remote computer system and interacts with its batch system, or job scheduler. The remote submission of jobs to a HPC system, the reception of a notification in meaningful states of the execution of the job and the control and monitoring of jobs sent are implemented. In addition, Posidonia keeps a history repository of simulations. In this repository, the input and output files of a job sent with Posidonia are available. The software also comes in several versions, including desktop, Android, and web interfaces; fully integration with given simulators/solvers has also been developed. We have designed Posidonia within the paradigm of object orientation using Java, and as a layered architecture that provides increased code reuse.

Adrian Amor-Martin, Ignacio Martinez-Fernandez, Luis Emilio Garcia-Castillo (*Department of Signal Theory and Communications, University Carlos III of Madrid, Leganés, Spain, e-mail: aamor@tsc.uc3m.es, luise@tsc.uc3m.es*)

Evaluation of Galerkin Interactions between Surface or Volumetric Elements

J. Rivero, Francesca Vipiana, Donald R. Wilton, W. A. Johnson*

The evaluation of reaction integrals between bases defined on surface or volumetric elements is a key step in the solution of integral equations by the method of moments. The usual approach is to separately evaluate the source and test integrals of the 4-D double surface or 6-D double volumetric integrals, with most of the effort concentrated on evaluating singular or near-singular source integrals.

More recent research on the evaluation of coplanar surface element reactions has highlighted the advantages of simultaneously evaluating the source and test integrals, with an accompanying reduction in the total number of sample points required. Key features of the proposed approach are the evaluation of a double radial integral for the inner integrals plus evaluation of a pair of source and test domain boundary contour integrals. The convergence of the contour integrals have been further accelerated by the introduction of appropriate transforms.

Recently the evaluation of coplanar surface element interactions has been extended to non-coplanar surface and volumetric elements by twice employing the surface and volumetric forms of the divergence theorem, respectively. Both element interaction forms reduce the innermost integrals to double radial integrals. The outer integrals of the surface integrals are over the bounding contours, and the outer volumetric integrals are over the bounding element faces. In the surface case, points in either the source or test element plane must be imaged in the plane of the other element. Rotational projections about an axis along the line of intersection of the source and test element planes have proved most convenient, but various imaging choices are also currently under investigation.

In the presentation, previous research will be briefly summarized; emphasis will be on current research, concentrating on the formulation and numerical results for general surface and

volumetric element interactions.

J. Rivero (*Dept. Tecnologia de los Computadores y de las Comunicaciones, Escuela Politécnica, Universidad de Extremadura, 10003 Cceres, SPAIN, jrivero@unex.es*)

Francesca Vipiana (*Dept. Electronics and Telecommunications Politecnico di Torino, Corso Duca degli Abruzzi 24, 10129 Torino, ITALY, francesca.vipiana@polito.it*)

Donald R. Wilton (*Dept. Elect. and Comp. Engr., Univ. of Houston, Houston, TX, 77204-4005, USA, wilton@uh.edu*)

W. A. Johnson (*Consultant, 219 Sharon Drive, N. E., Albuquerque, NM, 87123, USA, w.johnson24@comcast.net*)

FEM-BCI: a Set of Hybrid Methods for the Computation of Electromagnetic Fields in Open Boundaries

Giovanni Aiello, Salvatore Alfonzetti, Nunzio Salerno

This paper presents in a unified way a set of hybrid methods, named FEM-BCI (Finite Element Method — Boundary Condition Iteration), already devised by the authors for the solution of several electromagnetic field problems, ranging from static and quasi static (electrostatic, time-harmonic skin effect, eddy current) to dynamic ones (scattering and radiation of electromagnetic waves), both for scalar and vector unknowns.

Similarly to the well known FEM-BEM (Boundary Element Method), FEM-BCI couples a differential equation for the interior problem with an integral one, which expresses the unknown boundary condition on the fictitious truncation boundary and involves the free-space Green's function. Differently from FEM-BEM, the support of the FEM-BCI integral equation is another surface strictly disjoint from the truncation boundary, so that singularities are avoided. Two kinds of FEM-BCI methods have been devised: FEM-DBCI (Dirichlet BCI) and FEM-RBCI (Robin BCI). Both methods have been successfully used for static and quasi static fields problems, whereas for high frequency field analysis only the sec-

ond one allows us to avoid resonances whatever the frequency.

In the FEM-DBCI method, the resulting hybrid global algebraic (real or complex) system is as follows:

$$\mathbf{A}\mathbf{v} = \mathbf{b}_0 - \mathbf{A}_T\mathbf{v}_T \quad (1)$$

$$\mathbf{v}_T = \mathbf{v}_{\text{ext}} + \mathbf{H}\mathbf{v} \quad (2)$$

where \mathbf{A} is a sparse matrix, \mathbf{v} is the array of the field values relative to the nodes or edges of the interior FE discretization, \mathbf{b}_0 is the known-term array due to internal sources and known Dirichlet and Neumann boundary conditions, \mathbf{A}_T is a sparse matrix similar to \mathbf{A} , \mathbf{v}_T is the array of the unknown field values on the truncation boundary, \mathbf{v}_{ext} is due to possibly external sources, and \mathbf{H} is a dense matrix.

To alleviate the heaviness of the integral equations (2), various techniques can be used to reach a lower complexity, such as the FMM (Fast Multipole Method) and hierarchical matrices. However, the integral equation still remains the most time-consuming part of the solving algorithm. Irrespective of whether such techniques are used for the integral equation, it is of great importance to minimize the number of times that these equations are solved in the context of an iterative solution.

The global system (1)-(2) may be solved by a simple iterative procedure: assuming an initial guess for the Dirichlet boundary condition \mathbf{v}_T on the truncation boundary, the FEM equations (1) are solved for \mathbf{v} by means of a standard solver for bounded problems, e.g. the conjugate gradient (CG) solver. The dense DBCI equations are then used to improve \mathbf{v}_T . These steps are iterated until convergence is reached. This solution strategy is efficient because the CG solver is applied to the sparse equations only, whereas the dense equations are used only a few times by fast matrix-by-vector multiplications. A more robust and efficient approach is based on the solution of the Schur-complement reduced system:

$$\mathbf{M}\mathbf{v}_T = \mathbf{k} \quad (3)$$

by means of the GMRES (Generalized Minimal Residual) solver.

Generally, FEM-BEM is more accurate than FEM-BCI, but requires much more computing time. Then, FEM-BCI appears more

appropriate for applications which require a shorter computing time, as for example in the stochastic optimization of electromagnetic devices, where some thousands of analyses must be performed to obtain satisfactory results. Conversely, FEM-BEM is more appropriate in cases in which a high level of precision is required in a single computation.

Giovanni Aiello, Salvatore Alfonzetti, Nunzio Salerno (*Dipartimento di Ingegneria Elettrica Elettronica e Informatica - Università di Catania*)

The Efficient Mixed FEM with Mass-Lumping and Impedance Transmission Boundary Condition for Computing Optical Waveguide Modes

*Na Liu, Guoxiong Cai, Qing Huo Liu**

Microwave and optical waveguide structures, such as dielectric waveguides, photonic crystal fibers, plasmonic, and hybrid plasmonic waveguides, gain their extensive applications in communications, integrated optics, and biophotonics. Advanced numerical methods with high efficiency and accuracy are required to determine the characteristics of propagation modes and to optimize geometrical and material parameters. An efficient mixed finite element method (mixed FEM) with mass-lumping technique and impedance transmission boundary condition (ITBC) is proposed for computing the optical waveguide modes with anisotropic and lossy media to avoid all spurious modes. By incorporating the Gauss' law into the vectorial wave equation, the variational formulation is completely free of spurious modes. It utilizes the curl-conforming linear tangential and quadratic normal (LT/QN) edge elements to expand the tangential components of the electric field, and the modified nodal-based scalar basis functions to expand the longitudinal component. Furthermore, to avoid the very fine spatial discretization of thin lossy sheet, ITBC has been proposed for the new mixed FEM formulations. Numerical examples verify that the mixed FEM with mass-lumping and ITBC techniques is free of any spurious eigenmodes

and has high efficiency. The new contributions of this work include: (a) the mixed FEM with mass lumping is proposed for the first time to remove all spurious modes. (b) The diagonal mass matrix and the smaller eigenvalue equation speed up the computation. (c) Both lossy and anisotropic media are made possible in the proposed method for optical waveguide problems. (d) The ITBC is first implemented in the new FEM formulation. Finally, numerical results on the rib waveguide, graphene plasmonic waveguide, and hybrid plasmonic waveguide clearly demonstrate that the proposed mixed FEM with mass lumping and ITBC technique is an efficient alternative method to determine optical waveguide modes.

Na Liu, Guoxiong Cai (*Institute of Electromagnetics and Acoustics, and Department of Electronic Science, University of Xiamen, Xiamen, Fujian, P. R. China, 361105, liuna@xmu.edu.cn; gxcai8303@xmu.edu.cn*)

Qing Huo Liu (*Department of Electrical and Computer Engineering, Duke University, Durham, NC, USA, 27708, qhliu@duke.edu*)

A New 3D DGTD Method Hybridizing the Finite Element and Finite Difference Techniques with Non-Conformal Meshes

Qingtao Sun, Qiang Ren, Qing Huo Liu

The conventional finite difference time domain (FDTD) method shows significant advantages in its linear computational complexity and no need for matrix inversion, but it is difficult to model complex geometries; on the other hand, the finite element time domain (FETD) method has advantages in flexible discretization of arbitrarily shaped geometries by employing tetrahedron elements, but it requires more expensive matrix inversion. To exploit both the efficiency of FDTD and the flexibility of FETD for electromagnetic modeling, an ideal approach is to hybridize these two methods so that large homogeneous or smoothly inhomogeneous regions are modeled by the FDTD method, while fine and complicated structures are modeled by the FETD method. There have been a number of successful efforts

to hybridize these two method based on various techniques. So far most implementations require a conformal mesh between the FDTD grid and the FETD mesh.

Recently, a 2D hybrid FETD/FDTD method was proposed based on the discontinuous Galerkin time domain (DGTD) method and the electric and magnetic field intensities \mathbf{E} and \mathbf{H} (B. Zhu, J. Chen, W. Zhong, and Q. H. Liu, "A Hybrid FETD-FDTD Method with Nonconforming Meshes," *Commun. Comput. Phys.*, vol. 9, no. 3, pp. 828-842, 2011; B. Zhu, J. Chen, W. Zhong, and Q. H. Liu, "Analysis of photonic crystals using the hybrid finite element/finite-difference time domain technique based on the discontinuous Galerkin method," *Intl. J. Numer. Methods Eng.*, vol. 92, no. 5, pp. 495-506, 2012). In this work, a new efficient 3D discontinuous Galerkin time domain (DGTD) method with hybrid FDTD/FETD method is proposed using the electric field intensity \mathbf{E} and magnetic flux density \mathbf{B} . The new contribution of the proposed hybrid DGTD method is that it allows the FETD mesh and the FDTD grid to be non-conformal for spatial discretization based on domain decomposition method. It implements the hybridization of FDTD and FETD with a buffer zone, which functions as a transition region between the FDTD grid and FETD mesh. The buffer zone helps the proposed hybrid method obviate the interpolation approach for field coupling of the non-conformal mesh and thus overcome the late-time instability issue encountered in hybrid methods. The discontinuous Galerkin method is employed to communicate fields between different regions, thus improving the coupling accuracy compared with using Dirichlet boundary conditions. The meshing procedures of the FDTD and FETD regions are completely independent in this hybrid method, thus preserving the meshing flexibility of the FETD method and facilitating the hybrid method for wider practical applications. Moreover, based on the discontinuous Galerkin method, the hybrid method allows the FETD region to be further split into multiple subdomains to reduce the computational complexity. For temporal discretization, a global leapfrog time integration scheme is implemented to sequentially update the fields in the FDTD, buffer, and FETD

regions. Finally, numerical results are shown to validate the accuracy and long-time stability of the proposed hybrid method and also demonstrate its meshing flexibility and computational efficiency inherited from FETD and FDTD methods.

Qingtao Sun, Qiang Ren, Qing Huo Liu (*Department of Electrical and Computer Engineering, Duke University, Durham, NC, USA, 27708, qhliu@duke.edu*)

Multiscale Finite Element Modeling for Composite Material Characterization

*Bi-Yi Wu**, *Xin-Qing Sheng*, *Yang Hao*

Composite materials such as high permittivity BaTiO₃ nanocomposites have great potentials to improve the performance of traditional dielectrics device in wide application range from capacitors, resonators to insulators. Due to the different spatial scale and high permittivity heterogeneities in the composite materials, a large number of discrete elements are required to accurately represent the geological model, and this leads to the conventional finite element simulations infeasible for particle 2D and 3D problems. In this paper, we investigate a new multiscale finite element method (FEM) for modeling characterization of composite materials.

To reduce the degrees of freedom of FEM, we construct multiscale basis functions for local regions. Unlike the conventional FEM using predefined basis functions, these multiscale basis functions are constructed by selecting the eigenfunctions of small local regions with robin boundary condition, because the linear combination of these eigenfunctions can represent any possible solution in the local region. Since using all the eigenfunctions of a local region is expensive, we perform a spectral decomposition in the span of eigenfunctions, thus we can achieve a good approximation of dominant eigenfunctions under desired accuracy. Although in a realistic simulation, we have to obtain basis functions for many local regions, these basis functions can be constructed offline and stored in a database. Numerical results

show the multiscale approach can efficiently model EM characterization of composite material with a significant reduction of calculation unknowns.

Bi-Yi Wu, Xin-Qing Sheng (*Center for Electromagnetic Simulation, School of Information and Electronic Engineering, Beijing Institute of Technology, Beijing, China, 01510700@bit.edu.cn, xsheng@bit.edu.cn*)

Yang Hao (*School of Electronic Engineering and Computer Science, Queen Mary College, University of London, London, E14NS, UK*)

SESSION: S8

PARALLEL COMPUTATION ON MULTI- AND MANY-CORE COMPUTERS

Organized by: Ali E. Yilmaz

**Parallel Wideband ACE-FMM for
Large-Scale Distributed-Memory
Clusters**

S. Hughey, H.M. Aktulga, B. Shanker

**A Parallel, Distributed-Memory
MLFMA for the Stochastic Galerkin
Method**

*Z. Zubac, J. Fostier, D. De Zutter, D.
Vande Ginste*

**Fast Scalable Parallel Direct Solu-
tions to Surface Integral Equations in
Computational Electromagnetics**

*B.M. Notaroš, A.B. Manić, X.S. Li, F.-H.
Rouet*

**Parallel MLFMA Accelerated
Higher-Order Solution of Large Scat-
tering Problems via Locally Cor-
rected Nystrom Discretization of
CFIE**

*M. Shafieipour, I. Jeffrey, J. Aronsson, V.
Okhmatovski*

**High-Performance Surface Integral
Equation Solver for Extreme Large
Multi-Scale Electromagnetic Prob-
lems**

Z. Peng, B. MacKie-Mason

**An Empirical Methodology for Judg-
ing the Performance of Parallel Algo-
rithms on Heterogeneous Clusters**

J.W. Massey, A. Menshov, A.E. Yilmaz

Parallel Wideband ACE-FMM for Large-Scale Distributed-Memory Clusters

S. Hughey, Hasan Metin Aktulga, Balasubramaniam Shanker

Demand for the ability to simulate extremely large and extremely detailed structures has necessitated the parallelization of standard computational methods for solving the Helmholtz equation in electromagnetics. By themselves, fast methods, i.e., those with asymptotic complexity less than the $\mathcal{O}(N^2)$ complexity of an iterative solver using dense linear algebra, no longer suffice for solving extremely large computational problems, with geometries spanning hundreds of wavelengths and hundreds of millions to billions of degrees of freedom (DoF). One such method is the fast multipole method (FMM) that is widely employed due to its efficiency and controllable accuracy; however, parallelizing this algorithm is a highly nontrivial endeavor.

Partitioning of the tree for Helmholtz FMM is uniquely difficult, given that the amount of work per tree node increases with the level number. Parallelization strategies for FMM vary, yet two key ideas permeate many existing algorithms. The quantities subject to distribution are the nodes of the tree (spatial partitioning) and their k -space samples (direction partitioning). Most approaches to parallel FMM, such as the hierarchical partitioning schemes (Ö Ergül and L. Gürel, “Hierarchical Parallelisation Strategy for Multilevel Fast Multipole Algorithm in Computational Electromagnetics”, *Electron. Lett.*, vol. 44, no. 6, pp. 34, 2008) and the hybrid wideband parallel FMM augmented with accelerated Cartesian expansions (ACE) (V. Melapudi, et al., “A Scalable Parallel Wideband MLFMA for Efficient Electromagnetic Simulations on Large Scale Clusters”, *IEEE Trans. Antennas Propag.*, vol. 59, no. 7, pp. 2565–2577, 2011), mix these as required for load balancing. The latter approach, which is the focus of this work, is based on the locally-essential tree (LET) concept equipped with direction partitioning. This algorithm has been shown to scale well up to 1024 processors for potential evaluation within a volumetric point cloud (> 90%), and up to 512 processors

for both potential evaluation within a spherical point cloud and in the context of an electromagnetic integral equation solver (> 85%).

In this work, we analyze in-depth the scalability of component stages of the wideband parallel ACE-FMM. We identify and address computational and algorithmic bottlenecks which inhibit the scalability of this scheme on modern large-scale clusters with an eye toward extreme-scale parallel computing.

S. Hughey, Balasubramaniam Shanker (*Department of Electrical and Computer Engineering, Michigan State University, East Lansing, MI, USA, hugheyst@egr.msu.edu, bshanker@egr.msu.edu*)

Hasan Metin Aktulga (*Department of Computer Science, Michigan State University, East Lansing, MI, USA, hma@cse.msu.edu*)

A Parallel, Distributed-Memory MLFMA for the Stochastic Galerkin Method

Zdravko Zubac, Jan Fostier*, Daniël De Zutter, Dries Vande Ginste

Algorithmic advances for the parallel, distributed-memory Multilevel Fast Multipole Algorithm (MLFMA) have led to implementations that can solve full-wave electromagnetic scattering problems with up to three billion unknowns on thousands of CPU cores (B. Michiels et. al, “Full-wave Simulations of Electromagnetic Scattering Problems with Billions of Unknowns”, *IEEE Trans. Anten. Propag.*, **63** (2), 2015, pp. 796–799). Dealing with such high number of unknowns requires highly optimized codes tailored to the problem at hand (scattering at PEC objects using the CFIE). In this talk, we will review the advances made and remaining challenges for this kind of simulations.

Additionally, we review the recent development of a parallel, distributed-memory implementation of a two-dimensional Stochastic Galerkin Method (SGM) solver (Z. Zubac et. al, “Efficient Uncertainty Quantification of Large Two-Dimensional Optical Systems with a Parallelized Stochastic Galerkin Method”, *Optics Express* **23** (4), 2015, pp. 30833–50). In

contrast to a deterministic solver, a stochastic solver allows for the incorporation of geometrical variation. This variation can e.g. originate from the manufacturing process and can degrade the performance of devices, e.g. optical systems. We show how the SGM can be leveraged with a parallel MLFMA. In turn, this allows for the handling of large optical structures in reasonable time frames: a 2D stochastic lens system with more than 10 million unknowns can be solved in less than one hour on a system with 48 CPU cores. For complex examples, the SGM achieves a speedup of more than 10 compared to a traditional collocation method, which relies on reusing a deterministic solver.

Zdravko Zubac, Jan Fostier*, Daniël De Zutter, Dries Vande Ginste (*Department of Information Technology (INTEC), Ghent University - iMinds, Technologiepark 15, 9052 Ghent, Belgium, jan.fostier@intec.ugent.be*)

Fast Scalable Parallel Direct Solutions to Surface Integral Equations in Computational Electromagnetics

Branislav M. Notaroš*, Ana B. Manić, Xiaoye Sherry Li, François-Henry Rouet

One of the most general and best established approaches to solving computational electromagnetic radiation and scattering problems is the one based on the method of moments (MoM) in the surface integral equation (SIE) formulation and the frequency domain. Inherently, the MoM results in dense linear systems, based on which the practical applicability of the MoM-SIE methodology is determined by extents and limitations in complexities and electrical dimensions of electromagnetic structures that they can handle for given computational resources, in terms of both computing time and memory requirements. One possible powerful general strategy aimed at extending the practical applicability of the MoM-SIE technique, considerably enhancing its efficiency in real-world simulations, is the use of fast direct solvers for the system of equations in conjunction with compressed storage of

large dense matrices and their parts. Another strategy implies using higher order basis functions for surface current modeling in conjunction with geometrical modeling by means of curvilinear parametric surface elements. The third strategy involves parallelization of the fast algorithms coupled with direct solvers in order to speed up the simulations of electrically large electromagnetic structures.

This paper explores and takes advantage of all three strategies outlined above in electromagnetic scattering analysis. It presents and discusses the analysis of large scattering problems using a fast scalable parallel direct solver based on hierarchically semiseparable structures (HSS), rank-revealing QR (RRQR) decomposition for memory compression, cobblestone distance sorting technique for geometrical preprocessing, and higher order MoM-SIE modeling (A. B. Manic, F.-H. Rouet, X. S. Li, and B. M. Notaros, “Efficient EM Scattering Analysis Based on MoM, HSS Direct Solver, and RRQR Decomposition,” *Proc. of 2015 IEEE International Symposium on Antennas and Propagation*, pp. 1660 – 1661). The parallelization strategy is implemented with ScaLAPACK, with the HSS tree being a task graph and data-dependency graph for all the different operations, compression, factorization, solution, and product, the tree parallelism coming from the fact that nodes lying on different branches of the tree can be processed in parallel, independently of one another, and the node parallelism consisting in assigning a node of the tree to multiple processes. For MoM-SIE matrix filling, in-core and out-of-core parallel codes for distributed memory systems based on the message passing interface (MPI) basic linear algebra communication subprograms (BLACS) are developed.

In addition, calculation of matrix instances that involve singular, hypersingular, near-singular, and near-hypersingular integrals defined on higher order curved quadrilateral MoM-SIE surface elements are dealt with by applying specially developed singularity extraction and cancellation methods. Note that these types of integrals are typical for matrix blocks that need to be calculated in full and stored as such, and that require higher accuracy.

Numerical examples evaluate the advantages of the different principal components of the presented methodology, such as the HSS-RRQR solver, higher order MoM-SIE modeling, parallelization techniques, and integration algorithms

Branislav M. Notaroš, Ana B. Manić (*Department of Electrical and Computer Engineering, Colorado State University, 1373 Campus Delivery, Fort Collins, CO 80523-1373, USA, notaros@colostate.edu, anamanic@engr.colostate.edu*)

Xiaoye Sherry Li, François-Henry Rouet (*Lawrence Berkeley National Laboratory, Computational Research Division, Berkeley, CA 94720-8150, USA, xsli@lbl.gov, frouet@lbl.gov*)

Parallel MLFMA Accelerated Higher-Order Solution of Large Scattering Problems via Locally Corrected Nystrom Discretization of CFIE

*Mohammad Shafieipour, Ian Jeffrey, Jonatan Aronsson, Vladimir Okhmatovski**

In various application such as antenna placement on the aircrafts, design of on-board radar antennas, and others, solution of large scale electromagnetic (EM) radiation and scattering problems with controlled precision is required. While the Method of Moments (MoM) discretization of the Combined Field Integral Equation (CFIE) has been the most common approach to the solution of the radiation problems involving electrically large platforms, such solutions do not allow for effective error controlled computations of the EM fields in the shaded regions important for electromagnetic compatibility (EMC) analysis. Higher-order (HO) alternative boundary element discretizations of the combined field integral equation (CFIE) such as HO Locally Corrected Nystrom (LCN) method or HO MoM are the methods of choice when computation of highly disparate strong and weak EM interactions is required within the same electrically large model. In this work we present HO LCN solution of the CFIE which is capable of providing error controlled computation of the near and far EM

fields in the problems of the antenna radiation on board of electrically large structures.

To enable the solution of the large scale scattering and radiation problems the presented LCN solution of the CFIE is accelerated with error-controlled point-based Multi Level Fast Multipole Algorithm (MLFMA) parallelized for distributed memory supercomputers using Message Passing Interface (MPI) (I. Jeffrey, et.al, "Error Controlled Solutions of Large-Scale Problems in Electromagnetics," *IEEE AP Mag.*, vol. **55**, 3, 2013, pp. 294-308). The parallelization of the HO solution requiring controlled digits of precision at all stages of computations presents various challenges compared to the traditional low-order (LO) MLFMA accelerated RWG MoM solutions of the CFIE. These include parallelization of global interpolation and interpolation operations in MLFMA instead of local ones in the LO schemes, processing of large near interactions sets in MLFMA associated with high-precision computations, joint handling of element-based near interactions in LCN and point-based MLFMA interactions, and others. These issues are discussed in the presentation. The scaling and parallel efficiency of the developed algorithm versus number of processors and problem size are also presented in this work.

Mohammad Shafieipour, Jonatan Aronsson, Vladimir Okhmatovski (*Dept. of Electrical and Computer Engineering, University of Manitoba, Winnipeg, Canada, vladimir.okhmatovski@umanitoba.ca*)

Ian Jeffrey (*CEMWorks Inc., Winnipeg, Canada, aronsson@cemworks.com*)

High-Performance Surface Integral Equation Solver for Extreme Large Multi-Scale Electromagnetic Problems

Zhen Peng, Brian MacKie-Mason*

Ever-increasing fidelity and accuracy needs for mission-critical electromagnetic (EM) applications have been pushing the problem sizes towards extreme scales. It puts a high premium on investigation of parallel and scal-

able integral equation (IE) simulators with optimal computational complexity. The objective of this research is to investigate an adaptive and parallel IE solver for extreme large multi-scale EM problems. The novelties and key ingredients of the proposed work include: (i) a geometry-adaptive discontinuous Galerkin boundary element method (DG-BEM), which permits the use of non-conformal surface discretizations and facilitates the mesh generation task for high-definition objects; (ii) a non-overlapping additive Schwarz domain decomposition (DD) method for the iterative solution of the DG-BEM matrix equations, which leads to a rapidly-convergent integral equation solver that is scalable for large multi-scale objects; (iii) an augmented multi-region multi-solver DD method via hierarchical skeletonization for hierarchical multi-scale simulation. The mathematical advancements of the proposed work enable an adaptive, parallel and scalable IE-based analysis framework well-suited for advanced distributed memory high-performance computing systems. The basic units of the parallel analysis framework consist of pre-processing, parallel computing and post-processing, all of which are formulated with proposed mathematical ingredients towards scalable parallelism. The appealing parallel simulation capabilities including: (1) trivially parallel mesh generation, (2) scalable convergence in the DD iterations, (3) automatic load-balanced computational partitioning, (4) embarrassingly parallel sub-domain solutions and (5) separable subdomain radiation couplings. Numerical experiments are performed on large computer clusters to characterize the performance of the proposed work. Finally, the capability and benefits of the resulting algorithms are exploited and illustrated through different types of real-world applications on high performance computing systems.

Zhen Peng, Brian MacKie-Mason (*Department of Electrical and Computer Engineering, University of New Mexico, Albuquerque, NM 87131-0001, USA, E-mail: pengz@unm.edu*)

An Empirical Methodology for Judging the Performance of Parallel Algorithms on Heterogeneous Clusters

*Jackson W. Massey, Anton Menshov, Ali E. Yilmaz**

The exponential increase in the (serial) performance of computers, which accompanied — and enabled — the advances in finite- and boundary-element methods and their application to increasingly more complex electromagnetic problems throughout the second part of twentieth century, ceased in the last decade as the conventional Dennard scaling of transistors came to an end. Subsequently, the main paradigm for increasing computer performance has become parallel computation on (homogeneous) processor architectures composed of multiple identical compute cores, e.g., a multi-core CPU or a many-core general-purpose GPU, on (heterogeneous) architectures that utilize multiple processor types, e.g., a multi-core CPU with a many-core coprocessor, and on clusters of such architectures. To continue benefiting from the increasing (parallel) performance of computers, finite- and boundary-element methods must be parallelized by using algorithms appropriate for the underlying architecture.

To judge whether a particular implementation of a parallel algorithm uses the computational resources efficiently enough when solving a given problem and whether an alternative implementation, algorithm, or architecture should be used, the implementation's performance must be systematically evaluated. Key in this evaluation are the *average computational power* $C_p = W/t_{seq,p}$ of each processor p and the *parallel efficiency* of the algorithm $e = W/C_{tot}t_{obs}$ where W denotes the workload, $t_{seq,p}$ denotes the wall-clock time needed to solve the problem by sequentially executing the algorithm on processor p , $C_{tot} = \sum_{p=1}^P C_p$ denotes the *total computational power* of the processors used, and t_{obs} denotes the observed wall-clock time (L. Pastor, J. L. B. Orero, "An efficiency and scalability model for heterogeneous clusters," *IEEE Int. Conf. Cluster Comp.*, 2001). To effectively interpret these quantities, which are functions of the num-

ber/type of processors used and the workload, the following methodology is proposed: (i) Construct a set of benchmark problems (e.g., scattering from spheres of different radii), define W for each problem (e.g., as the sphere radius), and estimate $C_{1,\dots,P}$ for the algorithm of interest. The problems in the set should be such that $C_{1,\dots,P}$ for large W can be estimated from those for small W . (ii) Solve the benchmark problems on different numbers and combinations of processors, record t_{obs} , and calculate C_{tot} and e for each solution. (iii) Plot isoefficiency contours on the $C_{tot} - W$ plane. (iv) Constrain t_{obs} to be smaller than a maximum time and e to be larger than a minimum efficiency; then, identify *regions of acceptable performance* in the $C_{tot} - W$ plane that meet these constraints.

The proposed methodology builds on the concept of *regions of acceptable parallelization* introduced in (F. Wei and A. E. Yilmaz, "A more scalable and efficient parallelization of the adaptive integral method part I: algorithm," *IEEE Trans. Antennas Prop.*, Feb. 2014) and extended to heterogeneous clusters in (F. Wei and A. E. Yilmaz, "A systematic approach to judging parallel algorithms: acceptable parallelization regions in the N-P plane," *FEM Int. Workshop*, May 2014). While that concept is appropriate for judging different algorithms for parallelizing a given (sequential) method on the same homogeneous/heterogeneous architecture, the proposed methodology is more general and can be used to also compare different methods or architectures. In this article, traditional direct and iterative method-of-moments solution of surface and volume integral equations are implemented on the Stampede cluster, whose nodes consist of two Intel Xeon 16-core processors and one 63-core Intel Xeon Phi co-processor. At the workshop, the proposed methodology will be used to evaluate the performance of the implementations with and without co-processors; implications for fast algorithms will also be proffered.

Jackson W. Massey, Anton Menshov (*Electrical and Computer Engineering, University of Texas at Austin, Austin TX, 78712, USA* jackson.massey@utexas.edu, anton.menshov@utexas.edu, ajilmaz@mail.utexas.edu)

OPTIMIZATION TECHNIQUES AND PARAMETER SPACE SWEEP

Organized by: Romanus Dyczij-Edlinger

Reduced Basis Model Reduction for Time-Harmonic Maxwell's Equations with Stochastic Coefficients

M. Hess, P. Benner

Adaptive Model-Order Reduction for the Simulation of Devices Fed by Dispersive Waveguides Based on the Finite-Element Scattering Formulation

R. Baltes, A. Sommer, O. Farle, R. Dyczij-Edlinger

Reduced-Basis Method for Geometric Parameters in Computer-Aided Design of Microwave Filters and Diplexers

V. de la Rubia, A. Lamecki, M. Mrozowski

Mesh Deformation Techniques in Parametric Modeling and Numerical Optimization of High Frequency Devices.

A. Lamecki, L. Balewski, M. Mrozowski

Proper Generalized Decomposition Method Applied to Solve 3D Low Frequency Electromagnetic Field Problems

T. Henneron, S. Clénet

Robust, Efficient and Accurate Computation of Nonlinear Eigenvalue Problems from Maxwell equations

M. Eller, S. Reitzinger, S. Schop, S. Zaglmayr

Reduced Basis Model Reduction for Time-Harmonic Maxwell's Equations with Stochastic Coefficients

Martin Hess*, Peter Benner

As the simulation of integrated circuits requires a significant amount of computational power, the simulation of large-scale models benefits greatly from using model order reduction (MOR) techniques. The original system size is typically reduced to a dimension of less than 100, which allows to examine the frequency response of parametrized systems using the reduced model.

The reduced basis method (RBM) is a model order reduction technique for parametrized partial differential equations (PDEs), which enables fast and reliable evaluation of the transfer behavior in many-query and real-time settings. We use the RBM to generate a low order model of an electromagnetic system governed by time-harmonic Maxwell's equations. The reduced order model then makes it computationally feasible to quantify the uncertainty by stochastic collocation and Monte Carlo simulation. The influence of the parametric variations on quantities of interest is measured in the form of expectation and variance of output functionals.

As numerical examples, we consider models in the microwave regime, which are governed by the time-harmonic Maxwell's equations. The high-fidelity model is discretized with the finite element method. Since we employ the second order formulation in the electric field, Nédélec finite elements are used to ensure a $H(\nabla \times \cdot)$ -conforming discretization. The RBM generates low order approximations to the parametrized partial differential equations (PDEs) and the approximation tolerance is certified with rigorous error estimators.

Given $Y : \Omega \rightarrow \mathbb{R}$, a square integrable random variable with probability density function f for a probability space $(\Omega, \mathcal{F}, \mathcal{P})$ and a function $g : \Gamma \rightarrow \mathbb{R}^d$, corresponding to a mapping of realizations of the random variable to the output of the electromagnetic system, stochastic collocation computes statistical quantities, like the mean, by a quadrature rule $\mathbb{E}(g(Y)) = \int_{\Gamma} g(x)f(x)dx \approx \sum_{i=1}^n g(\xi_i)w_i$, where the re-

alizations ξ_i are the sample points and the weights w_i are determined using the probability density function f . Monte Carlo simulations use equally weighted samples, which have been generated using the underlying distribution. A drawback of the Monte Carlo simulation is its slow convergence rate of $1/\sqrt{n}$. We use stochastic collocation in sparse grids of the Stroud- or Hermite-type. Anisotropic sparse grids can give additional computational advantages over isotropic grids.

Using the RBM on parametric systems with deterministic parameters shows exponential convergence rates. The talk will cover numerical results when applying the RBM in combination with Monte Carlo simulation and stochastic collocation.

Martin Hess, Peter Benner (*Max Planck Institute for Dynamics of Complex Technical Systems, Sandtorstr. 1, 39106 Magdeburg, Germany, benner@mpi-magdeburg.mpg.de*)

Adaptive Model-Order Reduction for the Simulation of Devices Fed by Dispersive Waveguides Based on the Finite-Element Scattering Formulation

Rolf Baltes*, Alexander Sommer, Ortwin Farle, Romanus Dyczij-Edlinger

The finite-element (FE) method is a powerful tool for simulating electromagnetic devices in the frequency domain. For exciting the FE system and extracting circuit parameters, impedance formulations are widely used. These are simple to implement but suffer from spurious resonances (O. Farle, M. Löscher, and R. Dyczij-Edlinger, "Efficient fast frequency sweep without nonphysical resonances," *Electromagnetics*, vol. 30, 2010, pp. 51–68). The scattering formulation avoids the occurrence of those spurious resonances, with the help of transparent port boundary conditions.

Since FE systems are of large dimensions, with frequency-dependent system matrices, the broadband analysis of real-world structures tends to be a time consuming task.

Model-order reduction (MOR) provides efficient methods for speeding-up computations. In the FE context, the self-adaptive reduced basis (RB) method (V. de la Rubia, U.Razafison, Y.Maday, “Reliable fast frequency sweep for microwave devices via the reduced-basis method,” *IEEE Trans. Microwave Theory Tech.*, vol. **57**, no. 12, 2009, pp. 2923–2937) is particularly suitable: It features exponential convergence, and there exist provable error bounds. In practical computations, the placement of expansion points is commonly determined by a greedy method, employing the relative residual norm.

The main prerequisite for the RB method is that the FE system features affine frequency parameterization. This is the case as long as the waveguides (WG) feeding the system exhibit frequency-independent transversal mode patterns, i.e. for homogeneous WGs. In the inhomogeneous case, in contrast, the modal field patterns and corresponding propagation coefficients exhibit complicated frequency dependences, for which closed-form expressions are usually unavailable. Thus, the RB method cannot be applied directly.

As for the impedance formulation, the issue of including frequency-dependent mode patterns in an RB framework was already addressed in (R. Baltes, A. Sommer, O. Farle, and R. Dyczij-Edlinger, “Adaptive model order reduction for structures fed by dispersive waveguide modes,” *International Conference on Electromagnetics in Advanced Applications (ICEAA)*, 2015, Sept. 2015, pp. 1072–1075). The case of the scattering formulation is more delicate because, in contrast to the impedance formulation, the frequency-dependent mode patterns do not only affect the right-hand side but also the system matrix.

This contribution presents a self-adaptive RB method for driven microwave problems which incorporates frequency-dependent mode patterns in a scattering formulation. In contrast to (Z. J. Cendes, and J.-F. Lee, “The transfinite element method for modeling MMIC devices,” *IEEE Trans. Microwave Theory Tech.*, vol. **36**, no. 12, 1988, pp. 1639–1649), the scattering formulation proposed in this work does not employ global unknowns corresponding to modal field patterns on port cross-sections.

The method uses reduced-order models for the mode patterns of the feeding WGs and results in a parameterized coupling to the driven problem. The key point is that this parameterization is of affine type, so that the whole procedure becomes accessible to RB-type MOR.

Rolf Baltes, Alexander Sommer (*Chair of Electromagnetic Theory, Dept. of Physics and Mechatronics, Saarland University, D-66123 Saarbrücken, Germany, r.baltes@lte.uni-saarland.de*)

Ortwin Farle, Romanus Dyczij-Edlinger (*CST AG, D-64289 Darmstadt, Germany*)

Reduced-Basis Method for Geometric Parameters in Computer-Aided Design of Microwave Filters and Diplexers

Valentín de la Rubia, Adam Lamecki, Michal Mrozowski

Finite Element Methods (FEM) have proven to be robust in solving the time-harmonic Maxwell’s equations for the analysis of microwave devices. However its computational cost is limiting its actual application for challenging Computer-Aided Design (CAD) problems in Computational Electromagnetics. Model Order Reduction (MORE) techniques may be applied to speed up the computational efficiency as well as to actually get further insight of the physics behind. Reduced-order models mainly deal with frequency, or equivalently, with time, as parameter to be taken into account, or even a few parameters more within a certain burden in order to deal with the so-called curse of dimensionality. However, when carrying out an actual microwave design, electrical specifications are difficult enough to fulfill for only taking a few parameters into account in the CAD problem, thus limiting again the actual application of MORE techniques in CAD for real life electromagnetic devices, leaving MORE for academic purposes rather than for practical ones.

In this work, we face the actual CAD problem for microwave filters and diplexers through reduced-order modelling, where not only fre-

quency is taking into account as a parameter but also all geometric parameters in the optimization problem are considered within the Reduced-Basis Method, i.e., the MORE technique. The Reduced-Basis Method relies on the assumption the electromagnetic field solution does not arbitrarily vary as a function of the parameter space but, on the contrary, evolves on a low dimensional manifold describing the physics. This is the approximation space the Reduced-Basis Method is after so that a reduced-order model of the parametric problem can be achieved. The basic ingredient for the Reduced-Basis Method to deal with geometry as a parameter, where indeed multiple geometric parameters are considered (say a few tens), is an efficient mesh deformation technique that is able to describe the FEM electromagnetic field solution within the same topological mesh. Special emphasis is placed on this to guarantee a proper application of the Reduced-Basis Method even though the geometric parameter space can be large.

Several real life microwave filter and diplexer designs will show the capabilities of this approach.

Valentín de la Rubia (*Departamento de Matemática Aplicada, Universidad Politécnica de Madrid, Avda. Complutense 30, 28040 Madrid, Spain, e-mail: valentin.delarubia@upm.es*)

Adam Lamecki, Michal Mrozowski (*Department of Microwave and Antenna Engineering, Faculty of Electronics, Telecommunications and Informatics, Gdansk University of Technology, Narutowicza 11/12, 80-233 Gdansk, Poland, e-mails: adlam@eti.pg.gda.pl, m.mrozowski@ieec.org*)

Mesh Deformation Techniques in Parametric Modeling and Numerical Optimization of High Frequency Devices.

*Adam Lamecki**, *Lukasz Balewski*, *Michal Mrozowski*

Stringent requirements for electrical specifications, mass, size and time-to-market delivery of passive high frequency components enforce engineers to look for more compact designs and

efficient design tools. The element in the design toolchain that enables to achieve these goals is an accurate electromagnetic simulator coupled with fast and reliable optimization technology. A typical design cycle based on electromagnetic simulator uses some kind of an iterative tuning method (based on an optimization procedure and a user-defined cost function) which requires a device to be simulated multiple times in order to fit the response to the required design specifications. It has to be noted that in conventional optimization involving a 3D FEM solver each tuning step is uncorrelated with previous steps in a sense that each simulation is performed from scratch. As a consequence, the first step in each cycle is to generate a new mesh, and as the geometry evolves, the number of unknowns at various intermediated stages may differ significantly. This results in the solution not being a smooth function of smooth shape evolution path. The effect can be observed in the simulated device's response as a meshing noise. The meshing noise is disadvantageous when numerical optimization is performed and may ultimately prevent convergence.

To eliminate remeshing at every tuning step mesh deformation technique can be used. Several variants of mesh deformation techniques have been considered in the literature, but so far very few publications deal with computational electromagnetics. At the workshop preliminary results related to the application of deformation technique based on solid mechanics integrated with a 3D FEM electromagnetic simulator (A. Lamecki et. al. , "An Efficient Framework For Fast Computer Aided Design of Microwave Circuits Based on the Higher-Order 3D Finite-Element Method, " *Radio-engineering*, **23** , 2014, pp. 970–978) will be reported and the advantages of this approach will be discussed.

Adam Lamecki, Lukasz Balewski, Michal Mrozowski (*Department of Microwave and Antenna Engineering, Faculty of Electronics, Telecommunications and Informatics, Gdansk University of Technology, Narutowicza 11/12, 80-233 Gdnask, Poland, ad lam@eti.pg.gda.pl*)

Proper Generalized Decomposition method applied to solve 3D Low Frequency Electromagnetic Field Problems

Thomas Henneron*, Stephan Clénet

In low frequency electromagnetic field problems, Maxwell's equations are discretised in the space and time domains using the finite element method combined with a time-stepping scheme. In the case of a fine mesh and a small time step, the computational time can be prohibitive. To reduce the computational time of time-dependent numerical models, Model Order Reduction (MOR) methods like the Proper Generalized Decomposition (PGD) have been proposed in the literature. This method has been mainly used to solve problems in mechanics (F. Chinesta, A. Ammar, E. Cueto, "Recent Advances and New Challenges in the Use of the Proper Generalized Decomposition for Solving Multidimensional Models", *Archives of Computational Methods in Engineering*, **17**(4), 2010, pp. 327–350). The PGD method consists in approximating the solution by a sum of separable functions. This approach can be applied to solve systems of partial differential equations in the time domain. In this context, the solution is approximated by a sum of separable functions depending on time and space (mode). Each mode is determined by an iterative process and depends on the previous modes. The time-dependent function satisfies an ordinary differential equation which can be solved numerically using a time-stepping method. The space-dependent function is the solution of a stationary partial differential equation which can be solved using the finite element method. In the case of non-linear problems, the PGD method is not also efficient as in the linear case, due to the additional computation cost of the non-linear terms. To circumvent this issue, the (Discrete) Empirical Interpolation Method ((D)EI) method can be combined with the PGD approach (M. Barrault, N. C. Nguyen, Y. Maday, and A. T. Patera. "An empirical interpolation method: Application to efficient reduced-basis discretization of partial differential equations", *C. R. Acad. Sci. Paris*, **339**(9), 2004, pp. 667–672, S. Chaturantabut and D. C. Sorensen, "Nonlinear Model Re-

duction via Discrete Empirical Interpolation", *SIAM J. Sci. Comput.*, **32**(5), 2010, pp.2737–2764). This method consists in interpolating the non-linear terms of the full model by calculating only some of their entries.

In this communication, we present the PGD approach in the case of low frequency electromagnetic problem coupling with external electric circuit solved by a vector potential formulation. As example of application, three devices are studied. The first is composed of two conducting plates submitted to a magnetic field created by a stranded inductor. The second example is a squirrel cage induction machine at standstill. The last one is a three phase transformer without load, the ferromagnetic material characteristic of the yoke is modelled by a non-linear B(H) curve. For all application examples, two types of supply voltage are considered. In the first case, sinusoidal voltage waveform is imposed. In the second case, a Pulse-Width Modulation (PWM) voltage is fixed. In order to evaluate the efficiency of the PGD method, each problem has been also solved with a classic EF model using an implicit Euler scheme.

Thomas Henneron (*Univ. Lille, EA 2697 – L2EP – Laboratoire d'Electrotechnique et d'Electronique de Puissance, F-59000, Lille, France, L2EP.univ-lille1.fr, thomas.henneron@univ-lille1.fr*)

Stephan Clénet (*Arts et Métiers Paris Tech, EA 2697 – L2EP – Laboratoire d'Electrotechnique et d'Electronique de Puissance, F-59000, Lille, France, L2EP.univ-lille1.fr, stephane.clenet@ensam.eu*)

Robust, Efficient and Accurate Computation of Nonlinear Eigenvalue Problems from Maxwell Equations

M. Eller, S. Reitzinger*, S.Schöps, S. Zaglmayr

The robust, efficient and accurate numerical solution of eigenvalue problems is required for many applications in science and engineering since the eigensystem gives a deep inside of underlying physical phenomena. Therefore the nonlinear algebraic eigenvalue problem

$$T(\lambda)X = 0$$

is considered, which stems from an appropriate (finite element) discretization. $T(s) : \Omega \subset \mathbb{C} \rightarrow \mathbb{C}^{N \times N}$ has to be a holomorphic matrix valued function, $\lambda \in \Omega$ denotes an eigenvalue with $X \in \mathbb{C}^N$ the corresponding eigenvector. Furthermore an affine decomposition of $T(\cdot)$ is assumed, i.e.,

$$T(s) = \sum_{i=1}^m \alpha_i(s) T_i$$

with $\alpha_i(s) : \Omega \subset \mathbb{C} \rightarrow \mathbb{C}$ a holomorphic scalar function and $T_i \in \mathbb{C}^{N \times N}$. In the talk the focus will be on Maxwell's equations, which comprises a nonlinear eigenvalue problem by nature, because of, e.g., dispersive material or absorbing boundary conditions. However it should be noted that other physics can be treated as well, e.g., mechanics, piezo-electric, etc., with the proposed method. For the Maxwell eigenvalue problem it is well known that there exists a huge eigenspace at $\lambda = 0$, which has to be treated correctly. Due to a dedicated low frequency stable formulation, which was introduced recently by the authors, this problem can be circumvented very elegantly.

We use the contour integral method introduced by W. Beyn as a building block for the above nonlinear eigenvalue problem. The advantage of this method is that all eigenvalues are found in a predefined bounded area $\Omega \subset \mathbb{C}$ with $\Gamma = \partial\Omega$. However, the numerical effort for applying the method for large systems is very high because of the equidistant sampling along, since the contour integral method requires the solution $Z(s)$ along a closed path Γ for some given source B , i.e.,

$$T(s)Z(s) = B$$

It has to be noted that the samples could be perfectly parallelized. However, due to the special representation of $T(\cdot)$ efficiency is gained by using a multipoint method along in order to compute a reduced order model for $Z(s)$. In addition error estimates can be provided via an approximation of the inf-sup constant to control the error of the reduced order model of $Z(s)$ with respect to the original $Z(s)$.

We will show numerical studies from industrial applications, especially from the external Q-factor calculation, which show the numerical

robustness, efficiency and accuracy of the proposed method.

M. Eller, S. Reitzinger, S. Zaglmayr (*TCST AG, Bad Nauheimerstr. 19, 64289 Darmstadt, Germany, {Martin.Eller, Stefan.Reitzinger, Sabine.Zaglmayr}@cst.com*)

S.Schöps (*Technische Universität Darmstadt, Institut für Theorie Elektromagnetischer Felder and Graduate School CE, Dolivostr. 15, 64293 Darmstadt, Germany, schoeps@gsc.tu-darmstadt.de*)

**Anisotropic Material Modeling in
FEKO with Hybrid FEM/MoM**

E.A. Attardo, M. Bingle, U. Jakobus

**Design, Finite Element Analysis and
Fabrication of a 3D Periodic Struc-
ture to Read the Temperature of the
Objects in Microwave Cavities**

A. Bostani

**Study of the Proximity Effect and
the Distribution Parameters of
Multi-conductor Transmission Line**

*L. Guizhen, G. Qingxin, Y. Hongcheng, L.
Zengrui*

**Finite Element Modelling of Liquid
Crystal-Based Microwave Devices**

*F. Anbal Fernandez, R. James, L. Seddon,
S.E. Day, D. Mirshekar-Syahkal*

**The Finite Element Method for 2400
MHz Cylindrical Waveguide Antenna
Modeling**

*E. El Kennassi, K.I. Janati, A. Dirhar, L.
Bousshine*

**A Proposal of Electromagnetic Field
Analysis Method for Airport Surface
in VHF Band**

*R. Kato, R. Suga, A. Kezuka, O.
Hashimoto*

Anisotropic Material Modeling in FEKO with Hybrid FEM/MoM

Elia A. Attardo, Marianne Bingle, Ulrich Jakobus

FEKO (Comprehensive Electromagnetic Analysis Software Suite (part of Altair HyperWorks), www.altairhyperworks.com/FEKO), is a comprehensive electromagnetic analysis software suite which includes a variety of solvers (full wave and high frequency asymptotic) to address a wide range of practical electromagnetic radiation and scattering problems from industry sectors like automotive, aerospace, naval, communications, and bio-electromagnetics/healthcare.



Fig. 1: Y-junction circulator loaded with a ferrite material.

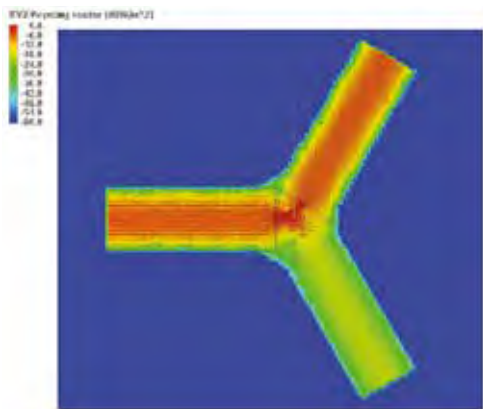

Fig. 2: Magnitude of Poynting vector.

In this contribution we present the recently added feature to the solution kernel of FEKO

14.0 for modeling fully anisotropic media. The analysis of the interaction of electromagnetic fields with anisotropic media is commonly used in microwave and millimeter wave systems, in investigating the variations of the radar cross section (RCS) for the electromagnetic cloaking, and, in general, for taking into account the presence of metamaterials. Anisotropic media are materials that exhibit characteristics that vary with the direction and polarization of fields. Such media are described by a dyadic permittivity and permeability (second-order) tensor. Among various solver methods available in FEKO, the Finite Element Method (FEM) proves to be of great versatility in modeling such complex materials. Modeling of general 3D volumetric anisotropic media is now supported for the FEM, and hybrid FEM / Method of Moments (MoM) solvers in FEKO.

As an application of modeling an anisotropic material, we present the simulation results for a waveguide Y-junction circulator loaded with a ferrite post. Circulators are mainly used in microwave and millimeter wave systems to isolate microwave devices. They make use of ferrite (anisotropic material) to achieve the desired isolation. Fig. 1 depicts the FEKO model of the junction obtained by merging together three rectangular waveguides of width 66 mm and of height 33 mm. The ferrite post (aluminum garnet G-610) is then placed in the middle and it is touching the top and bottom waveguide walls. The anisotropic material is magnetized along the vertical direction and its permeability tensor is described by means of the so-called Polder tensor. The FEM solver in FEKO is used to characterize the device for the principal mode (TE_{10}) excited on port 1. The selected working frequency is 3.05 GHz. Fig. 2 shows the magnitude of the Poynting vector. The anisotropic ferrite post breaks the reciprocity of the device (S-parameters: $S_{11} = -12.003$ dB, $S_{21} = -0.548$ dB, $S_{31} = -12.566$ dB) allowing the energy to flow from port 1 to port 2 with port 3 being isolated.

Elia A. Attardo (Altair Engineering GmbH, Böblingen, 71034, Germany, attardo@altair.de)

Marianne Bingle, Ulrich Jakobus (Altair Development S.A. (Pty) Ltd, Stellenbosch, 7600, South Africa, jakobus@altair.com, mbingle@altair.co.za)

Design, Finite Element Analysis and Fabrication of a 3D Periodic Structure to Read the Temperature of the Objects in Microwave Cavities

Ali Bostani

A new 3-D periodic structure is proposed that is designed the way to have a stop band at 2.45 GHz which is the operating frequency of the common microwave heating devices. The structure features an opening which is large enough to pass the infra red emissions of the objects inside the microwave cavity to enable a thermopile installed outside the chamber to read the temperature of the objects inside. The unit cell of the structure was designed with the aid of the FE Eigen analysis to locate the stop bands, then analyzed deterministically with a FE solver and finally the structure with three unit cells was fabricated and satisfactory results have been achieved in real life.

Microwave heating devices have been widely utilized both industrially and domestically in the past few decades. Presence of the hot spots and cool spots in multimode cavities and also the difference in the polarity of the molecules of the objects being heated in the microwave chambers have been motivating the researchers to explore different methods to monitor the status of the object inside and more particularly the temperature of the object. Thermopiles are used to measure the infra red emission by the modes of heat loss of the object and can be used to read the temperature from a fair distance, however they need a decent size window to receive the IR emissions. When it comes to microwave cavities, it is a huge challenge to introduce a window as the microwave leakage through that window creates numerous difficulties such as electromagnetic interference, safety concerns and loss of energy of course. Ideally a structure is required that stops the microwave leakage while still allows the IR emissions to pass. Periodic structures have been a matter of great interest due to the merit of introducing pass bands and stop bands. These bands are identified and the level of the propagation and the attenuation is determined by dispersion analysis of the periodic structure. Fi-

nite Element method has been successfully applied for dispersion analysis of arbitrary shaped three dimensional periodic structures both in pass band and stop band over a desired range of the frequencies (Bostani, A.; Webb, J.P., "Finite-Element Eigenvalue Analysis of Propagating and Evanescent Modes in 3-D Periodic Structures Using Model-Order Reduction," *Microwave Theory and Techniques, IEEE Trans.*, vol.60, no.9, pp.2677–2683).

In this paper an electromagnetic band gap structure is proposed that introduces a stop band at ISM frequencies between 2.4 GHz and 2.5 GHz in which the commercial generator class microwave devices operate. The opening of this EBG structure allows the IR emissions to pass freely to be delivered to a thermopile that is attached to the wall of the cavity.

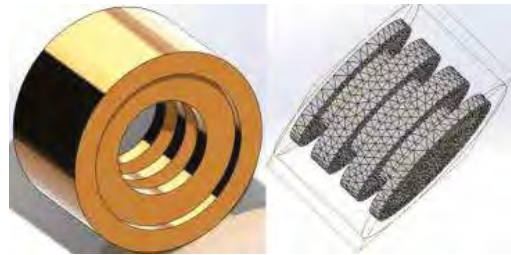

Fig. 1: a) The antenna mesh plot in vertical plane, b) Finite element simulation of our antenna in vertical plane V/m.

The unit cell of the proposed EBG structure is a 3 mm metallic cylinder with the diameter of 10 mm. An iris is loaded inside the cylinder with a thickness of 1 mm and inner diameter of 7 mm. The unit cell was analyzed by Eigen analysis method of *Bostani-Webb* after several iterations to find the right dimensions. Then due to the limited space, as only three unit cells could fit the designated place, another deterministic FE analysis was conducted by an s-parameter solver of commercial software and effectiveness of the whole structure in attenuating the radiation was confirmed. The structure was fabricated and tested on a microwave oven and the temperature was satisfactory read by the IR sensor.

Ali Bostani (*Department of Electrical Engineering, American University of the Middle East, Egaila, Kuwait, ali.bostani@aum.edu.kw*)

Study of the Proximity Effect and the Distribution Parameters of Multi-Conductor Transmission Line

Lu Guizhen*, Guo Qingxin, Yin Hongcheng, Li Zengrui

In this work, we show how we use the vector potential finite element method (VP-FEM) to investigate the distribution parameters of multi-conductor transmission line (MTL) with the proximity effect. The VP-FEM has been used to investigate power transmission line, which focus on studying the relationship between the skin effects and the transmission efficiency, as well as the effects of field distribution on the environment. In the first part, we summarize the methods which have been presented for calculated the distribution parameters of MTL. Then we theoretical analysis the functional and computing equations of the VP-FEM, and detailed discuss how we numerically calculate the inductance of MTL. Three typical transmission line structures are calculated by using VP-FEM.

The first case is a coax which has a closed structure. The magnetic flux density as well as the per-unit-length inductance have been calculated by the presented method. The result shows that the distribution of the magnetic flux density increase gradually along the radial direction and then decrease quickly within the inner conductor, namely, its peak appear at the boundary of the inner conductor. The per-unit-length inductances of the coax with different diameter are compared with the analytical results. The high agreement between them verify that the proposed method is effective.

Next, we investigate a parallel lines with an opened structure, whose infinite calculation domain has been truncated by the infinite element method during calculating. The simulation results of the magnetic flux density around the parallel lines illustrate that, in the cross section, most of the magnetic flux distribute in the vicinity of the two conductors and the highest magnetic flux density appear at the space between them. For investigating the proximity effect, the inductances which corresponds to different conductor's diameter are calculated in case of the distant of the parallel line cen-

ter is invariant. The analytical results and the proposed numerical results of the per-unit-length inductance exhibit that there is deviation between them, and the difference rise as the diameters of the conductors increasing. The compared results testify that the proximity effect influences the per-unit-length inductance of multi-conductor lines.

At last, we calculate the magnetic flux density and the inductance matrix of a coupled microstrip. The distribution of the magnetic flux density around the coupled lines illustrate that it is affected by the proximity effect too. The inductance matrix obtained in the proposed method different from that presented in previous work, in which the proximity effect hasn't been taken into account. All cases imply that the presented vector potential finite element method is suitable for calculating the distribution parameters of multi-conductor transmission line with the proximity effect

Lu Guizhen, Yin Hongcheng, Li Zengrui (*School Of Information Engineering, Communication University of China, No.1, Dingfuzhuang East Street, Chaoyang District, Beijing, 100024, China, luguizhen@cuc.edu.cn, qxguo@cuc.edu.cn, zrli@cuc.edu.cn*)

Guo Qingxin (*Science and Technology on Electromagnetic Scattering Laboratory, No.50 Yongding Road, Haidian District, Beijing, 100854, China, yinhc207@126.com*)

Finite Element Modelling of Liquid Crystal-Based Microwave Devices

F. Aníbal Fernández*, Richard James, Lawrence Seddon, Sally E. Day, Dariush Mirshekar-Syahkal

Liquid crystal (LC) substrates provide a convenient means to fabricate reconfigurable or tunable microwave devices. The large anisotropy shown by LC materials, of the order of 25% and higher, permits to obtain a wide range of tunability, which can be achieved by the application of external, low-frequency electric or magnetic fields. Device fabrication is inexpensive and the voltage and power requirements to operate them are very low.

The work described here consists of the finite element (FE) modelling of the liquid crystal

behavior when electric fields are applied, necessary to find the permittivity distribution in the LC substrate, combined with the full modelling of the electromagnetic fields in the entire device. The LC substrate's permittivity is a full tensor that varies from point to point through the device, so commercial EM modelling packages are not suitable. The FE modelling of the LC substrate is based on a variational formulation for the Gibbs energy including the elastic and electric energies in the LC. The relation between electric and elastic behavior is highly nonlinear and the solution is achieved by iterations within a time-stepping approach. This results in the LC director distribution and from this, the permittivity distribution in the substrate can be found. This is mapped onto the (FE) mesh of the entire device and the electromagnetic field propagation is calculated using a full-field approach implemented with tangential FE elements, using perfect conductor walls, absorbing boundary conditions or boundary elements for radiating structures. The excitation field is provided by a modal analysis at a designated input port, based on the transverse electric field and also implemented with tangential FE elements.

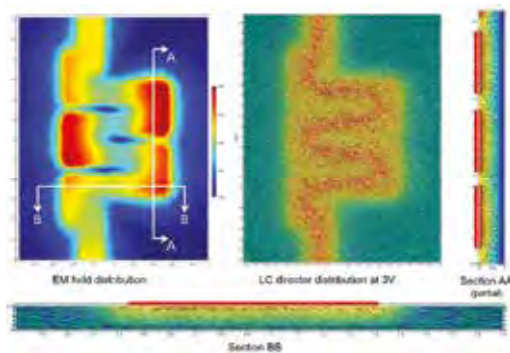

Fig. 1: Cross-section view of a meander-line phase shifter showing the electric field distribution.

F. Aníbal Fernández, Richard James, Lawrence Seddon, Sally E. Day (Department of Electronic and Electrical Engineering, University College London, Torrington Place, London WC1E 7JE, UK, a.fernandez@ucl.ac.uk)

Dariusz Mirshekar-Syahkal (School of Computer Science and Electronic Engineering, University of Essex, Wivenhoe Park, Colchester CO4 3SQ, UK, dariush@essex.ac.uk)

The Finite Element Method for 2400 MHz Cylindrical Waveguide Antenna Modeling

Essaid El kennassi, Khalid Idrissi Janati, Amine Dirhar, Lahbib Bousshine*

This work is in accordance with the field of directive antennas modeling. We used the FEM to solve electrical field radiated by a cylindrical waveguide antenna. The Galerkin's minimization method is formulated over the cylindrical shape and then we introduce inside this shape a cylindrical feed. The model used supposes that the antenna is a perfect electric conductor PEC, which radiates at a frequency equal to 2400 MHz. We formulated the bi-dimensional finite element analysis for the wave equation with the presence of an excitation source, which model a feed probe Fig. 1. The boundaries used are the Dirichlet boundaries, and the first order absorbing boundary conditions ABC, which simulates the continuity of wave propagation at the domain truncature. The determination of the electrical field pattern in horizontal and vertical planes gives idea on the tri-dimensional field pattern. The presence of the feed probe and his geometrical characteristics affects the field obtained.

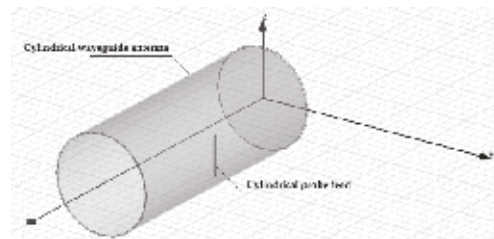

Fig. 1: Cylindrical waveguide antenna with the feed probe in the Cartesian coordinate system.

Finite element results Fig. 2. b, and Fig. 3. a-b, show that the polar plot of our cylindrical antenna has directional pattern. This antenna is directive in the horizontal, and the vertical plane.

Essaid El kennassi, Khalid Idrissi Janati, Amine Dirhar, Lahbib Bousshine (Department of Mechanics, University of Hassan II, km 7, Route d'El Jadida, Casablanca, Morocco, essaid.elkennassi@orange.fr, janati.id02@gmail.com, dirhar.medamine@gmail.com, lbousshine@yahoo.fr)

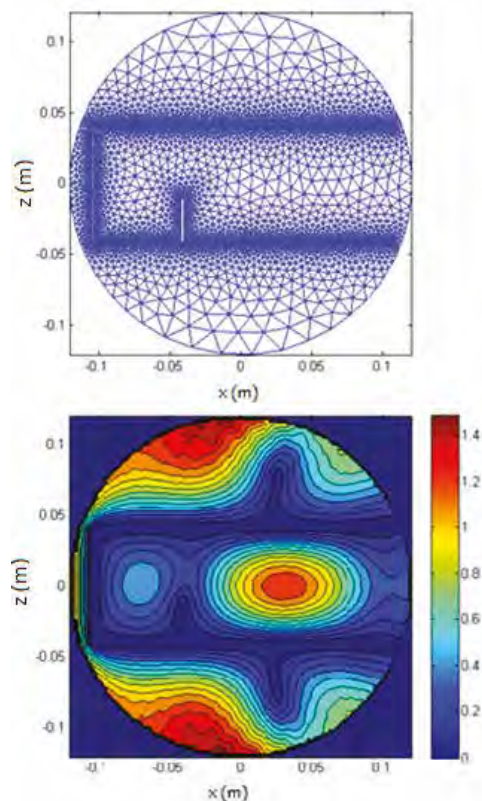

Fig. 2: a) The antenna mesh plot in vertical plane, b) Finite element simulation of our antenna in vertical plane V/m.

A Proposal of Electromagnetic Field Analysis Method for Airport Surface in VHF Band

R. Kato, Ryosuke Suga, Atsushi Kezuka, Osamu Hashimoto*

Ground based augmentation system (GBAS) has been proposed as a new landing system using the GPS, and it includes a VHF data broadcast (VDB) transmitter. The augmentation information for the landing is sent to airplanes through the transmitter. The received power of more than -72 dBm is required at 3.6 meters high from the runway in order to support the auto landing. An electromagnetic field analysis is effective to meet the requirement. The finite element method (FEM) is, however, not practical because the airports are too large compared with the wavelength in the

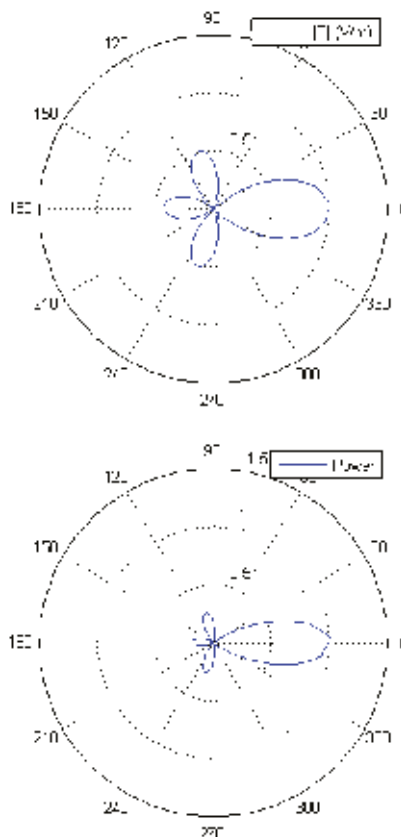

Fig. 3: a) Electric radiation pattern V/m, b) Power radiation pattern dBi.

VHF band. Moreover the ray-tracing method also has some difficulties in calculation including small buildings whose size is several wavelengths. In this paper, a new electromagnetic field analysis method for the airport surface in the VHF band is proposed. Figure 1 shows an example of a layout of terminal buildings and a VDB antenna at an airport.

Two buildings are only in the vicinity of the terminal area. The buildings are placed at the distance of 5 meters from the VDB antenna. Their sizes and interval are 6 meters and are shorter than several wavelengths. The antenna is set at 5 meters high from the ground. The proposed method is a hybrid of FEM and ray-tracing method. The electromagnetic field in the terminal area is calculated by FEM. The direct wave above the runway can be obtained by near-far field transformation of the FEM results. Besides, the variations of the power

above the runway due to the ground reflections are calculated by the ray-tracing method (in this case, two rays ground reflection model without buildings). The power above the runway is obtained by the product of the direct wave and the variation by the ground. The airport model is analyzed to confirm the validity of the proposed method. An observation line is above the runway and is 3.6 meters high as shown in Fig. 1.



Fig. 1: Layout of the airport.

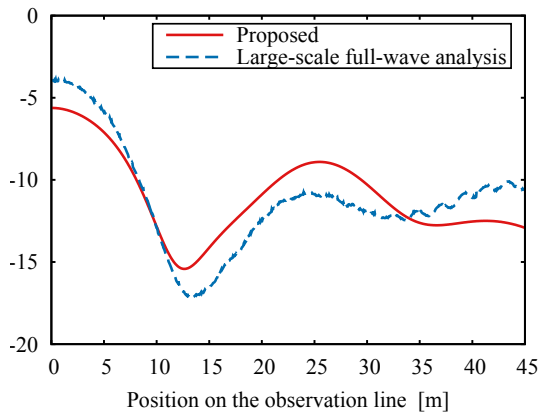

Fig. 2: Power above the runway (100 MHz, Horizontally polarized wave).

Figure 2 shows the simulated received powers on the observation line by using both the proposed method and a large-scale full-wave analysis. The full-wave analysis takes about 20 hours. On the other hand, the proposed method takes about 3 hours and the power calculated by the proposed method agrees with the full-wave one within 2 dB error. Therefore the validity of the proposed method is indicated.

R. Kato, Ryosuke Suga, Osamu Hashimoto (Department of Electrical Engineering and Electronics, Aoyama Gakuin University, 5-10-1 Fuchinobe, Chuo-

ku, Sagami-hara-shi, Kanagawa 252-5258, Japan. r-kato@ee.aoyama.ac.jp, rsuga@ee.aoyama.ac.jp)

Atsushi Kezuka (National Research and Development Agency, Electronic Navigation Research Institute, 7-42-23 Jindaiji-higashimachi, Chofu-shi, Tokyo 181-0012, Japan. kezuka@enri.go.jp)

DOMAIN DECOMPOSITION AND NON-LINEAR FEM

**Combined Domain Decomposition
and Model Order Reduction to
Solve Complex RF Problems Using
FEniCS**

*T. Flisgen, Johann Heller, Ursula van
Rienen*

**A Spurious-Mode Free Jacobi-
Davidson Method Combined with
Domain Decomposition for the
Modal Analysis of Electromagnetic
Structures**

*O. Floch, R. Baltes, A. Sommer, R.
DyczijEdlinger*

**Efficient FEM Software Package In-
tegration with Evolutionary Algo-
rithms for Large Electromagnetic
Problems**

*E. Agastra, A. Lala, B. Kamo, L.
Ntibarikure*

**FEM-Based Optimization of Dummy
Loads for High-power Wideband Mi-
crowave Calorimeters**

V.Yu. Kozhevnikov, A.I. Klimov

**Localized Diffusive Source Esti-
mation via an Hybrid Finite Ele-
ment/Kalman Filtering Approach**

*G. Battistelli, L. Chisci, N. Forti, G.
Pelosi, S. Selleri*

**Coupled Discontinuous Galerkin
Time-Domain Simulation of the Non-
linear Electromagnetic-Plasma Inter-
action**

S. Yan, J.-M. Jin

Combined Domain Decomposition and Model Order Reduction to Solve Complex RF Problems Using FEniCS

Thomas Flisgen*, Johann Heller, Ursula van Rienen

The determination of radio-frequency (RF) properties of complex structures is a demanding task in microwave engineering. For instance, the direct discretization of a chain with four superconducting multicell-cavities as used in particle accelerator applications typically leads to a system of equations with more than 107 degrees of freedom. The straightforward solution of problems with this complexity requires high performance computing (HPC) environments which are expensive to acquire and to maintain. To avoid the need of HPC, the recently proposed State-Space Concatenation scheme (refer to Figure 1) can be used. The method is based on the decomposition of the complex structure into segments. Subsequently, state-space models (SSM) to describe the radio-frequency properties of the individual segments are created by discretization approaches such as the Finite Integration Technique (FIT) or the Finite Element Method (FEM). Then, model order reduction (MOR) is applied to obtain considerably more compact SSM for the segments. These compact SSMs are combined by means of

eld continuity constraints to a SSM of the full structure. Finally, this model is further reduced to a compact SSM of the complex structure which allows for the thorough analysis of RF properties of the complex geometry on workstation servers. The contribution discusses the SSC scheme and the challenges which arise when constructing reduced-order models for the segments of the structure using the FEM in combination with the open-source toolkit FEniCS. In particular, issues like avoidance of inverting the mass matrix, stability of the reduced-order models, and the low-frequency breakdown will be in the focus of the talk.

Thomas Flisgen, Johann Heller, Ursula van Rienen (*Institute of General Electrical Engineering, University of Rostock, Albert-Einstein-Str. 2, 18059 Rostock, Germany, Thomas.Flisgen@Uni-Rostock.de*)

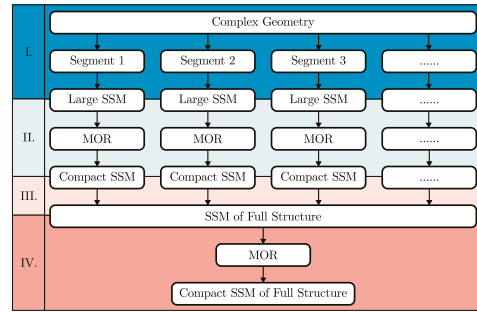

Fig. 1: Figure 1: Workflow of the State-Space Concatenation (SSC) approach.

A Spurious-Mode Free Jacobi-Davidson Method Combined with Domain Decomposition for the Modal Analysis of Electromagnetic Structures

Oliver Floch*, Rolf Baltes, Alexander Sommer, Romanus Dyczij-Edlinger

Modal analysis is an important technique for characterizing the electromagnetic (EM) behavior of resonant structures. Applications range from microwave filters over cavities to particle accelerators. Among the numerical methods available, the finite-element (FE) method stands out for its great flexibility in handling complicated geometries and nonhomogeneous material properties.

While the dimension of the resulting discretized eigenvalue problem tends to be very high, the number of eigenpairs that are of practical interest is usually small. Therefore, specialized numerical methods are required which compute selective eigenpairs only. In this context, Krylov subspace methods combined with shift-and-invert preconditioning are very popular (Z. Bay, J. Demmel, J. Dongarra, A. Ruhe, and H. van der Vorst, “Templates for the Solution of Algebraic Eigenvalue Problems,” *Philadelphia, PA: SIAM*, 2000). One drawback of such methods is that preconditioning requires a high degree of accuracy in solving an auxiliary FE system at each iteration step. In contrast, the Jacobi-Davidson (JD) method (G. L. G. Sleijpen and H. A. van der Vorst, “A Jacobi-Davidson iteration method for linear eigenvalue problems,” *SIAM J. Matrix Anal. Appl.*, vol. 17, pp. 401–425, 1996) em-

employs a subspace based on inexact Newton directions. Hence approximate solutions to the JD correction equation suffice, and solution accuracy may be adjusted in accordance with the residual of the eigenpair approximation. For these reasons, the JD method in combination with an effective iterative solution method is well suited for large-scale FE problems.

Another difficulty in characterizing EM cavity problems is the occurrence of zero eigenvalues corresponding to nonphysical solutions. As a consequence, when eigenvalues of small modulus are sought, special measures must be taken to prevent convergence of the JD method toward such unphysical resonances.

This contribution presents a JD method for the modal analysis of EM cavities which prevents nonphysical solutions by imposing a constraint equation. The JD correction equation is solved approximately, using a block-diagonal preconditioned conjugate orthogonal conjugate gradient method (H. A. van der Vorst and J. B. M. Melissen, "A Petrov-Galerkin type method for solving $Ax = b$, where A is symmetric complex," *IEEE Trans. Magn.*, vol. **26**, no. 2, pp. 706–708, 1990), wherein the diagonal blocks correspond to a FE discretized potential equation and a Helmholtz problem, respectively. As a result, preconditioning requires the solution of these two auxiliary problems. Since their dimensions tend to be high, one has to resort to iterative techniques, like Krylov sub-space methods. For these techniques, the availability of efficient preconditioners is of utmost importance. In this work, the Helmholtz problem is solved by a non-overlapping domain decomposition method based on higher-order transmission conditions (Vineet Rawat and Jin-Fa Lee, "Nonoverlapping domain decomposition with second order transmission condition for the time harmonic Maxwell's equations," *SIAM Journal on Scientific Computing*, vol. **32**, pp. 3584–3603, 2010).

The talk will detail the underlying theory and present numerical examples that demonstrate the validity of the suggested approach.

Oliver Floch, Rolf Baltes, Alexander Sommer, Romanus Dyczij-Edlinger (*Chair of Electromagnetic Theory, Dept. of Physics and Mechatronics, Saarland University, D-66123, Saarbrücken, Germany, o.floch@lte.uni-saarland.de*)

Efficient FEM Software Package Integration with Evolutionary Algorithms for Large Electromagnetic Problems

Elson Agastra, Argenti Lala, Bexhet Kamo, Laurent Ntibarikure

The finite element method is a powerful method for the approximate solution of boundary value problems governed by partial differential equations. Nowadays, finite elements in computational electromagnetics has become an invaluable part in radio frequency and microwave application designs, and many packages are widely available to perform these tasks.

However, there remain a lot of problems to be solved or optimized for automatic CAD design especially for large problems which may not be solvable on a single common workstation. Domain decomposition methods are still an open area of research. These allow to solve smaller parts of a large problem and to achieve the whole solution upon proper interconnection. In microwave application design, tools able to optimize or automatically modify some design parameters are as important as the methods used for structure analysis. For this purposes and to take advantage of FEM method in general and Domain Decomposition in particular this tools are integrated with evolutionary optimization tools for microwave filter and horn antenna design. Moreover, to take advantage of Domain Decomposition and evolutionary optimization techniques a high parallelization efficiency, multicore enabled element matrices computation is implemented with OpenMP (Open Multi-Processing) libraries.

In this presentation, a finite element package integrated with evolutionary optimization tools for microwave passive devices analysis and design will be presented.

Elson Agastra, Argenti Lala, Bexhet Kamo (*Department of Electronics and Telecommunications, Polytechnic University of Tirana, Sheshi Nene Tereza 1, 1004 Tirana, Albania, eagastra; alala; bkamo@fti.edu.al*)

Laurent Ntibarikure (*GE Oil & Gas, Florence, Italy, ntilau@gmail.com*)

FEM-Based Optimization of Dummy Loads for High-Power Wideband Microwave Calorimeters

Vasily Yu. Kozhevnikov*, Aleksei I. Klimov

Development of high-power microwave (HPM) sources is of great interest for civil and military applications nowadays. HPM power measurements dealing with pulses with more than 2 GW power with 10-100 ns durations demand novel instrumentation. In laboratory routine calorimeters with three-layered wide-aperture dummy load filled with ethanol-based working liquid are proved to be the most appropriate for HPM-related measurements (A.I. Klimov et al., "Measurement of Parameters of X-Band High-Power Microwave Superradiative Pulses," *IEEE Trans. Plasma Sci.*, 36, 3, 2008, pp. 661–664) Theoretically, due to use of ribbed shape input window (at Fig. 1) dummy load has to be almost perfect absorbing structure for incident microwaves of desired operating band (here 1-12 GHz). In fact, incident wave reflection from dummy loads nontrivially depends on incident wavelength, and it unfavorably increases at low frequency range of the operating waveband. In order to manufacture suitable dummy load one need to provide optimum geometrical parameters with respect to wideband reflection coefficient. Experimental optimization of the dummy load's geometrical parameters is appreciably limited. Therefore, the most effective way is to perform optimization numerically. Finite element method in



Fig. 1: Dummy load for HPM TM_{011} calorimeter.

frequency domain (implemented in COMSOL

Multiphysics 4.2a with RF module) has been successfully used to perform full-wave simulation of TM_{01} electromagnetic mode propagation into axisymmetric three-layered HPM calorimeter dummy load (Fig. 2). We investigated only the case of normal incidence taking into the account certain measurement conditions. We also used experimentally obtained frequency dependencies for dielectric permittivity and loss tangent for all considered dielectric materials (polycarbonate, PA-6, HDPE, ethanol-based liquid). Metal case and rear wall were assumed to be perfect electric conductors (PEC). To obtain high accurate results we have chosen a tetrahedral mesh replicating exact geometric relief of ribbed input window of a dummy load. We have adopted our

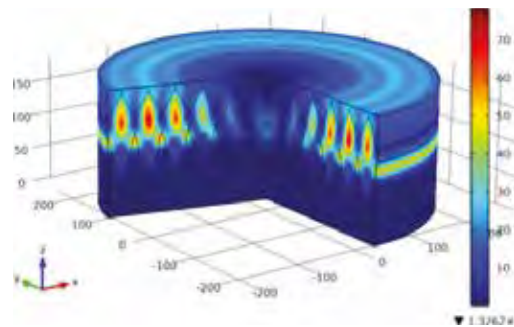

Fig. 2: Computed spatial distribution of time-averaged energy density (in J/m^3 units) in HPM calorimeter dummy load at 6.5 GHz.

forward 2D-axisymmetric model to perform Nelder-Mead gradient-free algorithm optimization routine in order to find optimal design geometrical parameters of three-layered dummy load structure. Total number of scalar parameters is five for the dummy load with metal rear wall, and six if rear wall is made of dielectric. We have obtained reflection coefficient as the objective function for Nelder-Mead optimization routine with maximum value restricted to 1.5-2.0%. The proposed approach makes possible obtaining optimized geometrical parameters of dummy loads intended for HPM-related energy measurements. In the framework of the proposed 2D-axisymmetric model, we have obtained reflection coefficients for wideband HPM calorimeter that are of great practical value for the manufacturing of real dummy loads.

Vasily Yu. Kozhevnikov (*Department of Theoretical Physics, Institute of High Current Electronics, Akademicheskyy ave. 2/3, 634055 Tomsk, Russia, Vasily.Y.Kozhevnikov@ieec.org*)

Aleksei I. Klimov (*Department of Physical Electronics, Institute of High Current Electronics, Akademicheskyy ave. 2/3, 634055 Tomsk, Russia, Vasily.Y.Kozhevnikov@ieec.org*)

Localized Diffusive Source Estimation via an Hybrid Finite Element/Kalman Filtering Approach

Giorgio Battistelli, Luigi Chisci, Nicola Forti, Giuseppe Pelosi, Stefano Selleri

Estimation of diffusive sources like heat, polluting agents, toxic biochemical substances, etc. has recently received great attention within both the control and signal processing communities thanks to technological advances which allowed for inexpensive deployable wireless sensors measuring the induced field and the strategic importance of such a task in homeland security, environmental and industrial monitoring.

By source estimation, here, we refer to the joint task of detecting the presence, localizing and estimating the intensity of a diffusive source and monitoring the induced field over an area. To this end, two mainstream approaches can be found in the literature, considering either the steady-state solution or the complete time evolution.

In order to allow faster detection and localization of slowly diffusing sources, in this contribution we will follow a dynamic approach, taking into account the spatiotemporal diffusion dynamics of the field. In particular, the spatiotemporal diffusion dynamics is modelled by an advection-diffusion partial differential equation (PDE) with appropriate boundary conditions and one point (concentrated) source is considered.

The finite element (FE) method is exploited for the solution of the PDE. After time-discretization, the original infinite-dimensional boundary value problem is, therefore, transformed into a finite-dimensional, possibly

large-scale, discrete-time linear system with state vector consisting of the field values in the nodes of the FE mesh, input vector representing the source intensity and input matrix depending on the source location.

Then, a multiple-model Kalman filtering approach to source estimation is undertaken by considering all hypotheses (modes) corresponding to the source location in any possible element of the FE mesh plus a further hypothesis accounting for the possible source absence, taking into account simulated measurements at a given number of fixed sensors as an input. Both cases of motionless source with unknown position and of moving source along an unknown path are addressed.

Giorgio Battistelli, Luigi Chisci, Nicola Forti, Giuseppe Pelosi, Stefano Selleri (*Department of Information Engineering, University of Florence, Via di S. Marta 3, 50139 Florence, Italy, name.surname@unifi.it*)

Coupled Discontinuous Galerkin Time-Domain Simulation of the Nonlinear Electromagnetic-Plasma Interaction

Su Yan, Jian-Ming Jin

The nonlinear interaction between electromagnetic (EM) fields and plasma motions makes the coupled EM-plasma system highly complicated and extremely attractive as a research topic for scientists and engineers. In order to understand the complicated EM-plasma interaction, physical models have to be constructed based on experimental observations and validated through numerical simulations. While the EM fields and waves are governed by Maxwell's equations, the behavior of plasmas is usually described in the six-dimensional phase space by the Boltzmann equation (J. A. Bittencourt, *Fundamentals of Plasma Physics*. New York: Springer-Verlag, 2004), which can be simplified to the particle models in the low-pressure and low-collision-frequency regime and the fluid models in the high-pressure and high-collision-frequency regime. These simplified plasma models govern the macroscopic quantities such as the particle density, velocity,

temperature, and energy, which depend nonlinearly on the EM field intensity. As a coupled system, the EM-plasma interaction is by its nature nonlinear, multiphysical, and multiscale, which poses extreme difficulties and challenges to the conventional numerical methods.

To simulate the EM-plasma interaction, the finite-difference time-domain (FDTD) method is most widely used because of its simplicity and high efficiency (R. Hockney, J. Eastwood, *Computer Simulations Using Particles*, McGraw Hill, 1981). However, the stair-case approximation of the solution domain, the finite difference approximation of the fields and their derivatives, and the leap-frog time-marching scheme used in the FDTD method result in an overall low-order accuracy. The finite-element time-domain (FETD) method, which is very popular in the solution of pure EM problems (J.-M. Jin, *The Finite Element Method in Electromagnetics*, 3rd ed. Hoboken, NJ: Wiley, 2014), can achieve high-order accuracy because of the use of unstructured meshes and high-order vector basis functions. Unfortunately, the application of the vector basis functions leads to a numerical solution that is only continuous in the tangential directions of the elemental interfaces, and the resulting discontinuous normal components of the fields will impose an unpredictable amount of force to the plasma and result in spurious solutions or even a numerical breakdown of the simulation. To overcome the issues of both methods, the discontinuous Galerkin time-domain (DGTD) method (J. S. Hesthaven, T. Warburton, *Nodal Discontinuous Galerkin Methods Algorithms: Analysis, and Applications*. New York: Springer, 2008) is employed to solve the coupled EM-plasma equations. Similar to the FETD method, the DGTD method can use unstructured meshes and high-order basis functions to achieve a high-order accuracy of the numerical solution. By employing nodal interpolatory basis functions to expand the physical quantities in the DGTD method, the field continuity in all directions can be guaranteed. In this talk, the coupled EM-plasma model will be introduced, with an emphasize on the appropriate plasma models for high-power breakdown phenomena in the microwave frequency range. The numerical scheme proposed for solving the coupled physical system will be

discussed. To improve the accuracy and efficiency of the numerical method, several advanced techniques are implemented and will be presented in the talk. The numerical method will be applied to the modeling and simulation of the EM-plasma interaction, specifically, the development and evolution of plasmas in a high-power environment, with its underlying physics discussed and analyzed.

Su Yan, Jian-Ming Jin (*Department of Electrical and Computer Engineering, University of Illinois at Urbana-Champaign, 306 N Wright St, Urbana, IL 61801, USA, suyan@ilinois.edu, j-jin1@ilinois.edu*)

**Structured Meshes Using Computed
Basis Functions**

M. Nazari, J.P. Webb

**On the Preconditioning of the Differ-
ential $A-\Phi$ Formulation**

Y.-L. Li, S. Sun, W.C. Chew, L.J. Jiang

**Impact of Causality on Computa-
tional Techniques**

T.K. Sarkar, M. Salazar-Palma

**Accurate and Efficient Nyström Vol-
ume Integral Equation Method for
the Maxwell Equations for Multi-
ple 3-D Scatters for Meta-Material
Applications**

W. Cai

**Modeling the Ion-Exchange Pro-
cess for Diffusion Waveguides Within
Thin Glass Sheets**

T. Kühler, D. Zhang, E. Griese

**Multiphysics Simulation of Inte-
grated Circuits with the Finite Ele-
ment Method**

T. Lu, J.-M. Jin

Structured Meshes Using Computed Basis Functions

Moein Nazari, Jon P. Webb

A structured finite element (FE) mesh is one built on a regular plan (usually Cartesian), like a finite difference grid. Since its inception, one of the strengths of FEM was recognized to be its ability to model geometries with oblique and curved material interfaces, and this was generally achieved by using an unstructured mesh, in which the elements were laid out in conformity to the model itself rather than to any preconceived regular plan. Largely, that is the approach still adopted in the FEM community and widely-used commercial codes employ unstructured meshes of tetrahedra.

However, the automatic generation of unstructured meshes for large, complex geometries continues to be complicated and computationally expensive, and often leads to poor element quality, at least locally. By contrast, the generation of structured meshes is fast and gives ideally-shaped elements (e.g., cubic). Motivated by this, there has been renewed interest in the structured approach in recent years. One such method is the Non-conforming Voxel FEM, or NVFEM. The computational domain is taken to be a rectangular box, which is initially subdivided into a regular grid of cubes. A cube which is intersected by any material interface is called nonuniform and is subdivided into 8 smaller cubes. This subdivision process continues for a number of levels. In this way, we arrive at a mesh that is made entirely of cubic elements of various sizes, that provides a good representation of the interfaces.

Except it doesn't – at least, not unless a very large number of elements is used, which leads to a system matrix much larger than the one required by conventional FEM for the same accuracy. We propose a technique that allows the nonuniform elements to do a much better job of representing the material interface within them, so that good accuracy can be achieved with a much smaller number of elements. The technique replaces the standard basis functions of the cubic edge element by computed basis functions (CBFs). These are determined at run time by solving a local FE problem within the element. The cost of find-

ing all the CBFs is proportional to the number of nonuniform elements and the CBFs have exactly the same support as the functions they replace. The size and sparsity of the system matrix is unchanged.

The method, known as CBF-NVFEM, is applied to the computation of the radar cross section of free-space scatters in the frequency domain. A simple absorbing boundary condition (ABC) is placed on the outer surface of the rectangular domain. The total field formulation is used and the ABC includes a term representing the incident plane wave. Results for various 3D, conducting and dielectric scatterers demonstrate that CBF-NVFEM takes considerably less computation time than NVFEM to achieve the same accuracy, and that it is comparable in performance with traditional, unstructured FEM.

Moein Nazari, Jon P. Webb (*Department of Electrical and Computer Engineering, McGill University, 3480 University Street, Montreal, QC, H3A 0E9, Canada, jon.webb@mcgill.ca*)

On the Preconditioning of the Differential $\mathbf{A}\text{-}\Phi$ Formulation

Y.-L. Li, S. Sun, W. C. Chew, L. J. Jiang

A mixed vector and scalar potential formulation ($\mathbf{A}\text{-}\Phi$ formulation) has been proposed to bridge quantum optics and electromagnetics (W. C. Chew, "Vector Potential Electromagnetics with Generalized Gauge for Inhomogeneous Media: Formulation," *Progress In Electromagnetics Research*, **149**, 2014, pp. 69-84). One advantage of the resultant equations (\mathbf{A} -equation and Φ -equation) is, compared to those based on the field formulation, their absence of low-frequency breakdown catastrophe. For the differential form of the $\mathbf{A}\text{-}\Phi$ formulation, the equations can be discretized compatibly using regular finite element method, by virtue of the differential forms theory and Whitney elements (Y.-L. Li, S. Sun, Q. I. Dai, and W. C. Chew, "Finite Element Implementation of the Generalized-Lorenz Gauged $\mathbf{A}\text{-}\Phi$ Formulation for Low-Frequency Circuit Modeling," *IEEE transactions on Antennas and*

Propagation, submitted).

The solution of the \mathbf{A} -equation is previously obtained based on the incomplete LU preconditioning and sparse approximate inverse techniques. However, as an explicit matrix system is dense and thus is expensive to compute. A solution based on the implicit matrix system and preconditioned iterative procedure is highly desired for problems with large number of unknowns. The basic philosophy for constructing an efficient preconditioner originates from the operators of the equations. Note that \mathbf{A} and Φ are essentially governed by the vector and scalar Helmholtz operators, which can be concluded from the homogeneous cases for the equations. The spectrum of the Helmholtz operator is similar to that of the governing one, despite the difference brought about by the inhomogeneity across the boundaries of the piecewise homogeneous media.

Furthermore, for low-frequency modeling, the Helmholtz operator reduces to the Laplacian, which can be employed, instead of the former, as the preconditioner. In this way, the computational cost of the preconditioner can be cut down greatly and considered as the setup cost for wideband analysis in the low-frequency regime.

Y.-L. Li, L. J. Jiang (*Department of Electrical and Electronic Engineering, The University of Hong Kong, Hong Kong, China, ylli@eee.hku.hk, ljiang@eee.hku.hk*)

S. Sun (*School of Electronic Engineering, University of Electronic Science and Technology of China, Chengdu, 611731, China, sunsheng@ieee.org*)

W. C. Chew (*Department of Electrical and Computer Engineering, University of Illinois at Urbana-Champaign, Urbana, IL 61801 USA, wchew@uiuc.edu*)

Impact of Causality on Computational Techniques

Tapan K Sarkar, Magdalena Salazar Palma

Causality is a phenomenon of nature. This principle has very far reaching implications. It is a very powerful universal principle and yet it has not been utilized to its fullest potential.

Particularly in engineering applications it has seldom been used. The objective of this presentation is to illustrate how to generate the phase from amplitude only data and also to extrapolate available functions from their given samples. This is one such example. Also, most problems in the real world can be described by a mathematical equation, which can be either elliptic, parabolic or hyperbolic. So once one identifies the physical phenomenon in the real world a mathematical model can be generated which provides a mathematical equation of the appropriate kind. So the bottom line is one needs to solve a mathematical equation. We then apply some numerical techniques to solve that equation by introducing some basis functions which in the ideal case are the eigenfunctions of the mathematical equation describing the physical process. At that stage physics is not relevant but a stable numerical solution procedure which can reliably solve the mathematical equation with an a priori estimate for the error characterizing the accuracy of the solution. Examples will be presented to illustrate how this can be accomplished in general.

Tapan K Sarkar (*Dept. of Electrical Engineering Syracuse University Syracuse, NY 13240 tk-sarkar@syr.edu*)

Magdalena Salazar Palma (*Dept. of Signal Theory and Communications Charles the Third University of Madrid Leganés, Madrid 28911 salazar@tsc.uc3m.es*)

Accurate and Efficient Nyström Volume Integral Equation Method for the Maxwell Equations for Multiple 3-D Scatterers for Meta-Material Applications

Wei Cai

In this talk, we present a new accurate and efficient Nystrom volume integral equation (VIE) method for the Maxwell equations for large number of 3-D scatterers with application in meta-materials. The Cauchy Principal Values that arise from the VIE are computed accurately using a finite size exclusion volume together with explicit correction integrals consisting of removable singularities. Also, the

hyper-singular integrals are computed using interpolated quadrature formulae with tensor-product quadrature nodes for several objects, such as cubes and spheres, that are frequently encountered in the design of meta-materials. The resulting Nystrom VIE method is shown to have high accuracy with a minimum number of collocation points and demonstrate p-convergence for computing the electromagnetic scattering of these objects. Numerical calculations of multiple scatterers of cubic and spherical shapes validate the efficiency and accuracy of the proposed method.

Wei Cai (*Beijing Computational Science Research Center, Beijing, China*)

Modeling the Ion-Exchange Process for Diffusion Waveguides within Thin Glass Sheets

Thomas Kühler*, Dudu Zhang, Elmar Griese

Increasing demands on the performance of printed circuit boards result in the need for new high bandwidth interconnection concepts. For this reason, several methods for integrating optical waveguides into electrical printed circuit boards are known. A novel approach is a local increase of the refractive index within thin-glass sheets by ion-exchange processes resulting in optical layers with embedded graded-index waveguides. These optical layers can be combined with conventional electrical layers in order to obtain electrical-optical printed circuit boards. Here we address modeling and simulation of the diffusion process in order to determine optimum process parameters and modeling and simulation of the propagation characteristics of the resulting graded index waveguides.

The ion-exchange process produces graded-index multimode waveguides where the refractive index profile depends strongly on the process itself and its parameters like temperature, ion concentration and diffusion time. For optimal propagation characteristics, the index profile has to match a certain distribution. Using only experimental methods, the optimization

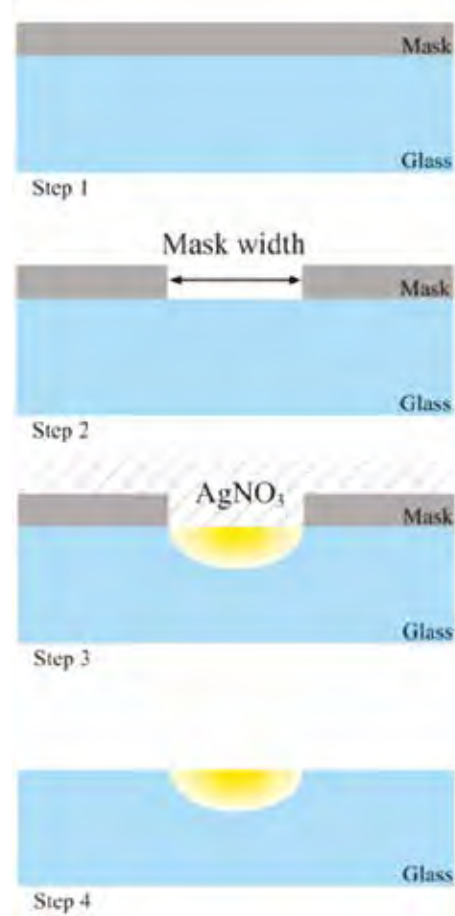

Fig. 1: Fabrication steps for producing GI-Waveguides in thin glass sheets.

of the index profile is a very time-consuming task. In this paper, a numerical approach using finite elements for modeling the thermal diffusion process is presented. As the propagation characteristics of the resulting graded index waveguides cannot be determined by analytical methods a finite element approach is used which is based on vector elements. Modeling and simulation result in detailed information about the modal propagation characteristics and the power distribution of the guided modes. From manufacturers point of view the derivation of the process parameters from the desired position and shape of the refractive index profile is of great interest. For that reason, the diffusion process is investigated in order to obtain the dependencies between the different parameters like diffusion time, geometrical mask parameters and concentration of the salt

melt. The two-dimensional refractive index profile can be reconstructed with a few characteristic data like the position and value of the maximum of the refractive index, the height and width of the index profile. The method derived for describing the diffusion process is used to calculate the dependencies between the parameters. The results are examined in regard to correlations. An artificial neural network with back propagation algorithm is developed. This model is able to determine process parameters for manufacturing optical waveguides with given optical properties.

Thomas Kühler, Dudu Zhang, Elmar Griese (*Department of Electrical Engineering and Computer Science, University of Siegen, Hölderlinstraße 3, 57548 Siegen, Germany, thomas.kuehler, dudu.zhang, elmar.griese@uni-siegen.de*)

Multiphysics Simulation of Integrated Circuits with the Finite Element Method

*Tianjian Lu, Jian-Ming Jin**

The advancement of the integrated circuit (IC) technology has been driven by the goal of increase in performance and functionality and decrease in cost and power. Over the years, the goal has been achieved by the continuous scaling of transistors and interconnects. Due to the continuous scaling, two problems emerge and become significant and challenging, namely, the ever increasing coupling among the multiphysics phenomena involved in the design and the large problem size arising from the escalating complexity of the design.

In order to address the strong couplings among the multiphysics phenomena, especially between the electrical designs and thermal issues, a multiphysics simulation is proposed and implemented based on the finite element method for its unmatched capabilities in modeling complex geometries and material properties (J. M. Jin, *The Finite Element Method in Electromagnetics*, 3rd edition, Hoboken, NJ: Wiley, 2014). The multiphysics simulation integrates three types of analysis into one single scheme: (1) electromagnetic analysis based on

Maxwell's equations, (2) fluid analysis based on conservation of mass and momentum, and (3) transient conjugate heat transfer analysis based on conservation of energy. The co-simulation considers the motion of fluid flow and takes into account the thermal effects of forced convective liquid cooling with integrated microchannels.

To perform the large-scale analysis in a highly efficient manner, a domain decomposition scheme called the finite element tearing and interconnecting (FETI) and FETI-enabled parallel computing (Y. J. Li and J. M. Jin, "A vector dual-primal finite element tearing and interconnecting method for solving 3-D large-scale electromagnetic problems," *IEEE Trans. Antennas Propag.*, vol. 54, no. 10, pp. 3000–3009, 2006) and an adaptive time-stepping scheme are incorporated into the proposed multiphysics simulation. Significant reduction in computation time is achieved through the two numerical schemes and the parallel computing with multiple processors.

The capability and efficiency of the multiphysics simulation is demonstrated through its applications in a variety of important problems, including the static and dynamic IR-drop analyses of power distribution networks, the thermal-aware high-frequency characterization of through-silicon-via structures, the full-wave electromagnetic analysis of high-power RF/microwave circuits, and the characterization of three-dimensional ICs with integrated microchannel cooling.

Tianjian Lu, Jian-Ming Jin (*Department of Electrical and Computer Engineering, University of Illinois at Urbana-Champaign, 306 N Wright St., Urbana, IL 61801, USA, {ftlu7, j-jin1}@illinois.edu*)

AUTHOR'S INDEX

A	
Accatino, L.	136
Agastra, E.	169
Aiello, G.	143
Aktulga, H.M.	147
Alfonzetti, S.	143
Amor-Martin, A.	136, 142
Aníbal Fernández, F.	162
Andriulli, F.P.	131
Aronsson, J.	150
Asdrubali, F.	118
Attardo, E.A.	160

B	
Balewski, L.	156
Baltes, R.	154, 168
Barbuto, M.	118
Battistelli, G.	171
Bellotti, E.	102
Benner, P.	154
Bertazzi, F.	102
Bilotti, F.	118
Bingle, M.	160
Boag, A.	125
Bonani, F.	103
Bostani, A.	160
Bousshine, L.	163
Brick, Y.	125
Burridge, R.	127

C	
Cai, G.	144
Cai, W.	175
Capizzi, G.	113
Cardelli, E.	114
Chernokozhin, E.V.	125

Chew, W.C.	174
Chisci, L.	171
Clénet, S.	156
Coco, S.	111
Corigliano, A.	107

D	
Davidson, D.B.	126
Day, S.E.	162
de la Rubia, V.	155
De Zutter, D.	148
Dinoi, L.	121
Dirhar, A.	163
Dolcini, F.	102
Donati Guerrieri, S.	103
Dyczij-Edlinger, R.	154, 168

E	
Eibert, T.	137
El Kennassi, E.	163
Eller, M.	157

F	
Faba, A.	114
Farle, O.	154
Finocchio, G.	112
Flisgen, T.	168
Floch, O.	168
Forti, N.	171
Fostier, J.	148

G	
Garcia-Castillo, L.E.	136, 142
Gentili, G. G.	120, 136
Ghione, G.	102, 103
Ghisi, A.	107

Giordano, A.....	112
Goano, M.....	102
Gori, P.....	118
Graglia, R.D.....	124, 125
Grasser, T.....	103
Griese, E.....	176
Guattari, C.....	118
Guizhen, L.....	161

H

Hao, Y.....	145
Hashimoto, O.....	164
Heldring, A.....	130
Heller, J.....	168
Henneron, T.....	156
Hess, M.....	154
Hongcheng, Y.....	161
Hosseini, F.....	126
Hughey, S.....	147

I

Iemma, U.....	110
Ilić, A.Ž.....	138, 139
Ilić, M.M.....	138, 139
Irace, A.....	104

J

Jüngel, A.....	103
Jakobus, U.....	160
James, R.....	162
Janati, K.I.....	163
Jeffrey, I.....	150
Jiang, L.J.....	174
Jiao, D.....	124
Jin, J.-M.....	171, 177
Johnson, W.A.....	142

K

Kühler, T.....	176
Kamo, B.....	169
Kato, R.....	164
Kezuka, A.....	164
Klimov A.I.....	169
Kozhevnikov, V.Yu.....	169

L

Lala, A.....	169
Lamecki, A.....	155, 156
Lange, S.....	137
Laudani, A.....	111, 112, 114
Li, J.....	130
Li, X.S.....	149
Li, Y.-L.....	174

Liu, N.....	144
Liu, Q.H.....	144
Lo Sciuto, G.....	113
Lombardi, G.....	125
Lozito, G.M.....	114
Lu, T.....	177
Lu, W.....	127
Ludick, D.J.....	126

M

MacKie-Mason, B.....	150
Maddio, S.....	120
Manić, A.B.....	149
Marchese, V.....	110
Mariani, S.....	107
Martinez-Fernandez, I.....	142
Massey, J.W.....	151
Matekovits, L.....	124
Mauri, A.G.....	105
Menshov, A.....	126, 151
Mirshekar-Syahkal, D.....	162
Mitharwal, R.....	131
Monti, A.....	118
Morhammer, A.....	103
Mosig, J.R.....	138
Mrozowski, M.....	155, 156
Muth, F.....	132

N

Nazari, M.....	174
Nesti, R.....	120
Notaroš, B.M.....	139, 149
Ntibarikure, L.....	169

O

Okhmatovski, V.....	126, 150
---------------------	----------

P

Pelosi, G.....	120, 171
Peng, Z.....	132, 150
Peterson, A.F.....	124
Petrini, P.....	124

Q

Qian, J.....	127
Qingxin, G.....	161

R

Ramaccia, D.....	118
Reitzinger, S.....	157
Ren, Q.....	144
Riganti Fulginei, F.....	114
Righini, M.....	120

Rius, J.M.	130
Rivero, J.	142
Robustillo, P.	138
Rossi, F.	102
Rouet, F.-H.	149
Rubio, J.	138
Rupp, K.	103

S

Sacco, R.	105
Salazar-Palma, M.	175
Salerno, N.	143
Salvini, A.	114
Sarkar, T.K.	175
Savić, S.V.	138, 139
Schneider, H.	132
Scholz, E.	137
Schop, S.	157
Scorrano, L.	121
Seddon, L.	162
Selleri, S.	120, 171
Shafieipour, M.	150
Shanker, B.	130, 147
Sheng, X.Q.	145
Sommer, A.	154, 168
Suga, R.	164
Sun, Q.	144
Sun, S.	174

T

Tobia, A.	118
Toscano, A.	118

U

Ubeda, E.	130
----------------	-----

V

Van Rienen, U.	168
Vande Ginste, D.	148
Vellucci, S.	118
Venter, G.	126
Venter, M.	126
Ventura, G.	110
Vipiana, F.	142
Volakis, J.	96

W

Webb, J.P.	96, 174
Wilton, D.R.	142
Wu, B.Y.	145

Y

Yan, S.	171
Yilmaz, A.E.	151

Z

Zaglmayr, S.	157
Zapata, J.	138
Zengrui, L.	161
Zhan, Q.	144
Zhang, D.	176
Zhou, B.	124
Zhou, X.	102
Zubac, Z.	148

ACKNOWLEDGMENTS

The editors of this book would like to acknowledge the kind support of:

Session organizers

Amir Boag, *Tel Aviv University, Israel*

Romanus Dyczij-Edlinger, *Universität des Saarlandes, Saarbrücken, Germany*

Giovanni Ghione, *Politecnico di Torino, Italy*

Antonio Laudani, *University of "Roma Tre", Italy*

Branislav Notaroš, *Colorado State University, Fort Collins, USA*

Alessandro Toscano, *University of "Roma Tre", Italy*

Balasubramaniam Shanker, *Michigan State University, East Lansing, USA*

Ali E. Yilmaz, *University of Texas at Austin, USA*

Juan Zapata, *Universidad Politécnica de Madrid, Spain*

Local Committee

Elson Agastra, *Polytechnic University of Tirana, Albania*

Stefano Maddio, *University of Florence, Italy*

Monica Righini, *University of Florence, Italy*

Conference Sponsors

IEEE Antennas and Propagation Society

ARES Consortium, Rome, Italy

The University of Florence, Italy

The Politecnico di Torino, Italy

MECSA, Rome, Italy

GAAS Symposium, Rome, Italy

And, for their invaluable support in obtaining «Memorabilia»

Mary E. Brennan *IEEE Central Offices*

David B. Davidson, *Stellenbosch University, South Africa*

Mahta Moghaddam, Editor-in-Chief of *IEEE Antennas and Propagation Magazine*

W. Ross Stone, past Editor-in-Chief of *IEEE Antennas and Propagation Magazine*

Elizabeth Silvester, Victoria, British Columbia, Canada

